

# LOGUE CATALOGUS CATALOGUE CATALOGO



**4K**

warn | connect | protect

[www.4K.be](http://www.4K.be)

2018



**warn | connect | protect**





<b>4</b>	4K	Geïsoleerde kabelschoenen	p 136
	4K	Gereedschap	p 135
	4K	Bundelbanden	p 142
	4K	Krimpkousen	p 129
	4K	LED signalisatie, markeerlichten en binnenverlichting	p 52
	4K	Magnetische werklamp op batterijen	p 86
	4K	Niet-geïsoleerde kabelschoenen	p 140
	4K	PVC-isolatiekousen	p 134
	4K	Zelfklevers	p 114
<b>A</b>	ABL	Stekkers, koppelstekkers, stopcontacten en industrieel contactmateriaal	p 87
	Acculux	Oplaadbare zaklampen en werklichten, noodlichtfunctie en Ex	p 78
	Adalit	Oplaadbare explosieveilige handlampen	p 76
	Auer Signal	Optische en auditieve signalisatietoestellen	p 34
<b>B</b>	BJB	Fittingen en toebehoren voor de verlichtingsindustrie	p 218
<b>C</b>	Calpe	Signaallampen voor bordenbouw	p 104
	Comtel	Sirenes voor grote gebieden	p 66
	Coroplast	Kleefband	p 161
<b>D</b>	Delta Design	Xenon en LED bakens	p 29
	Dinuy	Dimmers en bewegingsmelders	p 189
<b>E</b>	E2S	Elektronische signalisatietoestellen	p 60
<b>F</b>	Fontini	Porseleinen schakelaars en designschakelaars	p 164
<b>G</b>	GLW	Adereindhulzen	p 118
	Grafoplast	Markering voor draad, kabel en elektrotechnische componenten	p 110
<b>H</b>	HellermannTyton	Kabelbevestiging, -bescherming & -identificatie	p 144
<b>L</b>	La Sonora	Motorsirenes	p 57
	La Sonora	Zwaailichten	p 51
	L'Ébenoïd	Schakelaars	p 214
	L'Ébenoïd	Stekkerblokken, stekkers en koppelstekkers	p 98
	L'Ébenoïd	Wandarmaturen	p 216
<b>N</b>	Nordic Lights	Werklichten voor zwaar rollend materieel	p 82
<b>O</b>	Orbis	Analoge en digitale tijdschakelaars	p 180
<b>P</b>	PIPS	Public, industrial and private signalling	p 12
<b>S</b>	Schneider Electric	Installatiemateriaal voor kabelbevestiging	p 126
	Suprabeam	Professionele LED zak- en hoofdlampen	p 68
<b>T</b>	Techno	Innovatieve waterdichte verbindingen en wartels	p 101
	Tekox	Lusterklemmen	p 123
	Thorsman	Installatiemateriaal voor kabelbevestiging	p 126





<b>4</b>	4K	Autocollants	p 114
	4K	Colliers de serrage	p 142
	4K	Cosses isolées	p 136
	4K	Cosses non isolées	p 140
	4K	Gaines isolantes en PVC	p 134
	4K	Gaines thermorétractables	p 129
	4K	Outils	p 135
	4K	Projecteur de travail magnétique rechargeable	p 86
	4K	Signalisation LED, feux de position et éclairage intérieur	p 52
<b>A</b>	ABL	Fiches mâles, fiches femelles, prises et matériel de contact industriel	p 87
	Acculux	Torches rechargeables et éclairage de chantier, de secours et Ex	p 78
	Adalif	Éclairage à main antidéflagrant rechargeable	p 76
	Auer Signal	Appareils de signalisation optiques et auditifs	p 34
<b>B</b>	BJB	Douilles et accessoires pour l'industrie d'éclairage	p 218
<b>C</b>	Calpe	Voyants pour tableaux	p 104
	Comtel	Sirènes pour grandes zones	p 66
	Coroplast	Ruban adhésif	p 161
<b>D</b>	Delta Design	Feux flash xénon et LED	p 29
	Dinuy	Variateurs et détecteurs de mouvement	p 189
<b>E</b>	E2S	Appareils électroniques de signalisation	p 60
<b>F</b>	Fontini	Gamme d'interrupteurs en porcelaine et design	p 164
<b>G</b>	GLW	Embouts de câble	p 118
	Grafoplast	Marquage pour fils, câbles et composants électrotechniques	p 110
<b>H</b>	HellermannTyton	Matériel de fixation, protection et identification de câblage	p 144
<b>L</b>	La Sonora	Feux rotatifs	p 51
	La Sonora	Sirènes à moteur	p 57
	L'Ébenoïd	Appliques murales	p 216
	L'Ébenoïd	Interrupteurs	p 214
	L'Ébenoïd	Multiprises, fiches mâles et fiches femelles	p 98
<b>N</b>	Nordic Lights	Projecteurs de travail pour poids lourds	p 82
<b>O</b>	Orbis	Interrupteurs horaires analogiques et digitaux	p 180
<b>P</b>	PIPS	Public, industrial and private signalling	p 12
<b>S</b>	Schneider Electric	Matériel de fixation pour câbles	p 126
	Suprabeam	Lampes LED de poche et frontales professionnelles	p 68
<b>T</b>	Techno	Connectiques et presse-étoupes innovantes et étanches	p 101
	Tekox	Raccords lustre	p 123
	Thorsman	Matériel de fixation pour câbles	p 126

## A

Aansluitdoos voor huishoudtoestellen	p	92
Adapters	p	99
Adereindhulzen - geïsoleerd	p	118 - 119
Adereindhulzen - machine	p	122
Adereindhulzen - niet-geïsoleerd	p	120 - 121
Adereindhulzen - twin	p	121
Adereindhulzen op rol	p	122
Afdekplaten - Garby	p	169 - 170
Afdekplaten - Garby Colonial	p	174 - 175
Aftakklemmen	p	124

## B

Bakens - LED - blits	p	17 - 19
	p	31
	p	52 - 53
Bakens - LED - explosie veilig	p	48 - 49
Bakens - LED - knipperen	p	16 - 17
	p	24 - 25
	p	48 - 49
Bakens - LED - multifunctie	p	16 - 19
	p	32
	p	34 - 37
Bakens - multitone sounders - combi	p	22 - 23
	p	27
Bakens - Q	p	34 - 39
Bakens - xenon	p	29 - 30
	p	32 - 33
Bakenstoebehoeren - Q	p	40
Bellen	p	44
Beschermsslagen	p	154
Beschermsslagen - detecteerbaar	p	159
Bewegingsmelders	p	199 - 212
Bewegingsmelders - afstandbediening	p	213
Binnenverlichting	p	56
Bundelbanden	p	142 - 144
Bundelbanden - detecteerbaar	p	156
Bundelbanden - drijvend	p	157
Bundelbanden - extreme toepassingen	p	160
Bundelbanden - haak-en-lus	p	149
Bundelbanden - hersluitbaar	p	148
Bundelbanden - RVS	p	150 - 151
Bundelbandsysteem	p	146 - 147
Bundelbandtangen	p	135
	p	145
	p	152
Buzzers	p	42 - 43

## C

Connectors - coax	p	100
-------------------	---	-----

Connectors - IEC 60320	p	100
Connectors - waterdicht	p	101 - 102
Constant light control	p	196 - 197
Constant light control - afstandsbediening	p	198

## D

Dimmers	p	189 - 195
	p	198
Dimmers - afstandsbediening	p	198
Dimmers - interface	p	198
Doorvoertules	p	127

## F

Fittingen voor fluorescentielampen	p	219 - 228
Fittingen voor gasontladinglampen	p	239 - 241
Fittingen voor gloeilampen	p	218
Fittingen voor halogeenlampen 230 V	p	236 - 238
Fittingen voor halogeenlampen laagspanning	p	234 - 235
Fittingen voor spaarlampen	p	229 - 233

## G

Gereedschap TRASP	p	110
-------------------	---	-----

## H

Haak-en-lus-band	p	149
Handlampen	p	76
	p	79
	p	86
Handlampen - explosie veilig	p	76
	p	81
Handlampen met noodlichtfunctie	p	80
Handlamptoebehoeren	p	77
Hangkoppelingen - rubber	p	89
Hoofdlampen - helmband	p	75
Hoofdlampen	p	72 - 74
Hoorns - elektromechanisch	p	40 - 41
Hoorns - elektronisch	p	65
Hulzen TRASP	p	112

## I

Inbouwdoos met stopcontact	p	94
Inbouwstekkers - CEE	p	96
Inbouwstopcontacten - CEE	p	97
Isolatiekousen - PVC	p	134

## K

Kabelklemmen	p	128
Kabelschoenen - geïsoleerd	p	136 - 139
Kabelschoenen - niet-geïsoleerd	p	140 - 141
Kabelslangen	p	153
Kabelwartels	p	153
Karakters TRASP	p	111



Kleefband	p	161 - 163	Schakelklok - astronomisch	p	187
Klemmen voor de verlichtingsindustrie	p	243 - 244	Schakelklokken - analoog	p	180 - 184
Koffer TRASP	p	113	Schakelklokken - digitaal	p	185 - 186
Koppelstekker - dubbele	p	98	Schakelkloktoebehoren	p	188
Koppelstekkers - CEE	p	96	Schroefklemmen	p	126
Koppelstekkers - Elamide	p	87	Schroefzadels - detecteerbaar	p	158
Koppelstekkers - PVC	p	91	Schroefzadels - extreme toepassingen	p	160
Koppelstekkers - rubber	p	88 - 90	Schroefzadels - RVS	p	152
Koppelstekkers met ring	p	98	Signaallampen	p	104 - 109
Krimpkous in dispenser	p	133	Sirenes - motor	p	57 - 59
Krimpkousen	p	129 - 133	Sirenes voor grote gebieden	p	59
Krimpkousen met lijm	p	130 - 133		p	64
Krimptangen	p	135		p	66 - 67
<b>L</b>			Soldeerverbinders	p	139
Lasdop	p	127	Starter kit TRASP	p	113
LED-pcb's - toebehoren	p	242	Stekkerblokken	p	98 - 99
Lichtforens	p	45 - 47	Stekkers - CEE	p	95
Light bars	p	50	Stekkers - Elamide	p	87
Lusterklemmen	p	123	Stekkers - PVC	p	91
<b>M</b>			Stekkers - rubber	p	88
Markeerlichten - LED	p	54 - 55		p	90
Markering	p	110 - 113	Stekkers - thermoplastic	p	92
Markering - RVS	p	152	Stekkers met ring	p	98
Modules - basis	p	13 - 15	Stootverbinders met lijm	p	139
Modules - geluid	p	20 - 21	Stopcontacten - Garby	p	166
	p	26	Stopcontacten - Garby Colonial	p	174
Modules - licht	p	16 - 19	Stopcontacten - inbouw	p	93
	p	22 - 25	<b>T</b>		
	p	27	Toebehoren - Garby	p	166 - 168
Multitone sounders	p	20 - 21	<b>V</b>		
	p	26	Veerklemmen	p	124
	p	60 - 63	<b>W</b>		
<b>N</b>			Wandarmaturen	p	216 - 217
Nagelklemmen	p	126	Wandstekkers - CEE	p	95
<b>O</b>			Wandstopcontacten - CEE	p	97
Oplaadbare batterijen	p	75	Wartels - IP68	p	102 - 103
<b>P</b>			Werklichten	p	80
Pluggen	p	128		p	86
Porseleinen klemmen	p	125	Werklichten - magnetisch	p	86
<b>R</b>			Werklichten - rollend materieel	p	82 - 85
Randbescherming	p	155	<b>Z</b>		
<b>S</b>			Zaklampen	p	68 - 71
Schakelaars	p	214 - 215		p	78 - 79
Schakelaars - Dimbler	p	176 - 179	Zaklampen - explosie veilig	p	81
Schakelaars - Garby	p	164 - 165	Zelfklevers	p	114 - 117
Schakelaars - Garby Colonial	p	171 - 173	Zwaailichten	p	51



## A

Accessoires Garby	p	166 - 168
Adaptateurs	p	99
Attache-câbles	p	128
Autocollants	p	114 - 117
Avertisseurs sonores	p	20 - 21
	p	26
	p	60 - 63

## B

Balises - avertisseurs sonores - combi	p	22 - 23
	p	27
Balises ATEX	p	48 - 49
Balises au xénon	p	29 - 30
	p	32 - 33
Balises - LED - clignotants	p	16 - 17
	p	24 - 25
	p	34 - 37
Balises - LED - multifonctions	p	16 - 19
	p	32
	p	34 - 37
Balises - LED - strobe	p	17 - 19
	p	31
	p	52 - 53
Balises Q	p	34 - 39
Balises Q - accessoires	p	40
Bandes en textile, auto-agrippantes	p	149
Batteries rechargeables	p	75
Boîtes de raccordement pour appareils électroménagers	p	92
Boîtier d'encastrement avec prise	p	94
Bornes de dérivation	p	124
Bornes sans vis	p	124
Borniers pour l'industrie de l'éclairage	p	243 - 244
Buzzers	p	42 - 43

## C

Caractères TRASP	p	111
Chevilles	p	128
Clips avec clou	p	126
Clips avec vis	p	126
Coffret TRASP	p	113
Colliers	p	142 - 144
Colliers détectables	p	156
Colliers en acier inoxydable	p	150 - 151
Colliers en textile, auto-agrippants	p	149
Colliers flottants	p	157
Colliers pour applications extrêmes	p	160
Colliers réouvrables	p	148
Colonnes lumineuses	p	45 - 47

Conduits	p	153
Connecteur universel	p	127
Connecteurs - IEC 60320	p	100
Connecteurs à encastrer - CEE	p	96
Connecteurs coaxiaux	p	100
Connecteurs étanches	p	101 - 102
Connecteurs murals - CEE	p	95
Constant light control	p	196 - 197
Constant light control - télécommande	p	198
Cosses isolées	p	136 - 139
Cosses non isolées	p	140 - 141

## D

Détecteurs de mouvement	p	199 - 212
Détecteurs de mouvement - télécommande	p	213
Douilles pour lampes à décharge	p	239 - 241
Douilles pour lampes à incandescence	p	218
Douilles pour lampes fluorescentes	p	219 - 228
Douilles pour lampes fluorescentes compactes	p	229 - 233
Douilles pour lampes halogènes 230 V	p	236 - 238
Douilles pour lampes halogènes basse tension	p	234 - 235

## E

Éclairage de chantier	p	80
	p	86
Éclairage de secours	p	80
Éclairage intérieur	p	56
Embouts - machine	p	122
Embouts de câble en chenilles	p	122
Embouts de câble isolés	p	118 - 119
Embouts de câble non-isolée	p	120 - 121
Embouts de câble pour deux conducteurs	p	121

## F

Feux de position à LED	p	54 - 55
Feux tournants	p	51
Fiche mâle double	p	98
Fiches femelles - caoutchouc	p	88 - 90
Fiches femelles - CEE	p	96
Fiches femelles - Elamid	p	87
Fiches femelles - PVC	p	91
Fiches mâles - caoutchouc	p	88
	p	90
Fiches mâles - CEE	p	95
Fiches mâles - Elamid	p	87
Fiches mâles - PVC	p	91
Fiches mâles - thermoplastique	p	92
Fiches mâles avec anneau	p	98
Fiches mâles avec anneau	p	98
Frettage automatique	p	146 - 147



## G

Gainé thermorétractable en distributeur pratique	p	133
Gaines de protection	p	154
Gaines isolantes en PVC	p	134
Gaines thermorétractables	p	129 - 133
Gaines thermorétractables avec colle	p	130 - 133

## H

Hublots	p	216 - 217
---------	---	-----------

## I

Interrupteur astronomique	p	187
Interrupteur horaires - accessoire	p	188
Interrupteurs	p	214 - 215
Interrupteurs - Dimbler	p	176 - 179
Interrupteurs Garby	p	164 - 165
Interrupteurs Garby Colonial	p	171 - 173
Interrupteurs horaires analogiques	p	180 - 184
Interrupteurs horaires digitaux	p	185 - 186

## L

Lampes de poche	p	68 - 71
	p	78 - 79
Lampes de poche ATEX	p	81
Lampes frontales	p	72 - 74
Lampes frontales - bande en silicone	p	75
Light bars	p	50

## M

Manchons à sertir avec colle	p	139
Manchons de soudure	p	139
Manchons TRASP	p	112
Marquage	p	110 - 113
Marquage en acier inoxydable	p	152
Modules - base	p	13 - 15
Modules lumineuses	p	16 - 19
	p	22 - 25
	p	27
Modules sonores	p	20 - 21
	p	26
Multiprises	p	98 - 99

## O

Outils de pose pour des colliers	p	135
	p	145
	p	152
Outils TRASP	p	110

## P

Passe-fils	p	127
Pinces à sertir	p	135

Plaques - Garby	p	169 - 170
Plaques - Garby Colonial	p	174 - 175
Platines LED - accessoires	p	242
Presse-étoupes - IP68	p	102 - 103
Prises - châssis	p	93
Prises à encastrer - CEE	p	97
Prises Garby	p	166
Prises Garby Colonial	p	174
Prises murales - CEE	p	97
Profils de protection	p	155
Projecteurs à main	p	76

	p	79
	p	86
Projecteurs à main - accessoires	p	77
Projecteurs à main - magnétique	p	86
Projecteurs de travail - véhicules lourds	p	82 - 85
Projecteurs à main ATEX	p	76
	p	81
	p	89

## R

Raccords de conduit	p	153
Raccords en porcelaine	p	125
Raccords lustre	p	123
Ruban adhésif	p	161 - 163

## S

Sirènes à moteur	p	57 - 59
Sirènes pour grandes zones	p	59
	p	64
	p	66 - 67
Sonnettes	p	44
Starter kit TRASP	p	113
Supports détectables	p	158
Supports détectables	p	159
Supports en acier inoxydable	p	152
Supports pour applications extrêmes	p	160

## T

Trompes - électromécaniques	p	40 - 41
Trompes - électroniques	p	65

## V

Variateurs	p	189 - 195
	p	198
Variateurs - interface	p	198
Variateurs - télécommande	p	198
Voyants	p	104 - 109

- ▲ Onze merken
- ▲ Nos marques

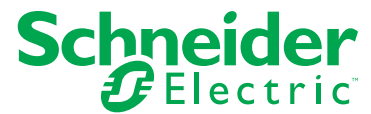

Auer Signal

ABL



DINUY



Your Connection to Light



HellermannTyton



Grafoplast®





## warn ▲

Industrial sirens & beacons  
Hazardous area signalling  
Signal towers  
Panel mount signalling equipment  
Fire warning devices  
Wide area & disaster signalling

## ▲ connect

Structured network cabling  
Fibre optic cabling & components  
19" Patch racks & server cabinets  
Industrial connectivity  
Coaxial cabling & connectivity  
Power distribution

## protect ▲

Heat shrink products  
Conduits & electrical cable sleeves  
Cable identification  
Rechargeable LED torches & head lamps  
Work & emergency hand lamps  
Explosion proof flashlights



### Onze witte catalogus al ontdekt?

In deze publicatie vind je een ruim gamma netwerkcomponenten zoals patchkabels en -panelen, connectoren en outlets maar ook netsnoeren en stekkerdozen. Kortom alles wat je nodig hebt om een volledig datanetwerk uit te bouwen en te onderhouden.

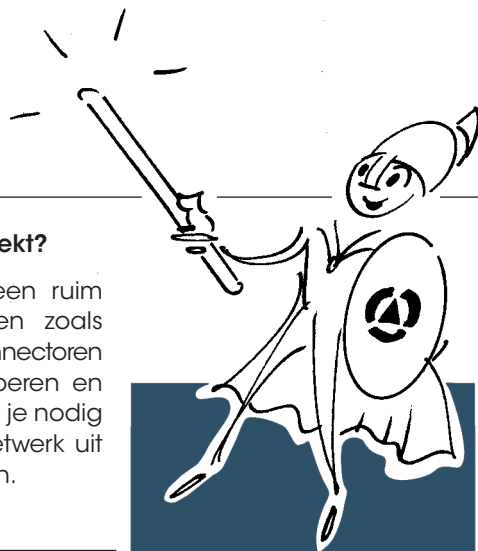

### Déjà découvert notre catalogue blanc?

Dans cette publication, vous trouverez une large gamme de composants réseau tels que des câbles et des panneaux de brassage, des connecteurs et des prises, ainsi que des cordons d'alimentation et des multiprises. En bref, tout ce dont vous avez besoin pour développer et maintenir un réseau data complet.

- ▲ PIPS - Signalisatie met oneindig veel mogelijkheden
- ▲ PIPS - Signalisation avec des possibilités infinies



### PIPS - Public, Industrial and Private Signalling

**PIPS** is het gloednieuwe paradepaardje in het signalatiegamma van 4K. Een uniek concept waarbij met 5 basissen en 11 licht- en/of geluidsmodules meer dan 1000 verschillende combinaties mogelijk zijn voor de grootste diversiteit aan signalisatietoepassingen.

Met **PIPS** vindt u in het 4K-gamma een enorm bereik aan multifunctioneel inzetbare licht- en/of geluidsignalisatie welke persoonlijk kan worden afgesteld. Het **PIPS-gamma** vertrekt vanuit 3 geluidsmodules, 5 lichtmodules en 3 gecombineerde geluids- en lichtmodules. Deze modules, in combinatie met 1 van de 5 verschillende basissen, zorgen voor een oneindige waaier aan mogelijkheden.

De **PIPS**-geluidsmodules bieden een regelbaar geluidsniveau van 65 dB tot 115 dB. De output van de lichtmodules is eveneens variabel. Op deze manier zorgt **PIPS** dat er voor iedere toepassing een oplossing beschikbaar is in het gamma. Onze specialisten helpen u graag de juiste keuze te maken. 4K helpt u alvast graag op weg met volgend overzicht:

### PIPS - Public, Industrial and Private Signalling

**PIPS** est le tout nouveau cheval de bataille de la gamme de signalisation de 4K. Un concept unique où il y en a avec 5 bases et 11 modules d'éclairage et/ou de sonorisation plus de 1000 combinaisons possible différentes pour la plus grande diversité d'applications de signalisation.

Grâce au système **PIPS**, vous trouverez dans la gamme 4K une énorme variante de signalisations lumineuses et/ou sonores multifonctionnelles pouvant faire l'objet d'une mise au point personnalisée. La **gamme PIPS** est composée de de 3 modules sonores, de 5 modules lumineux et de 3 modules combinés (sonores et lumineux). En combinaison d'une des 5 bases différentes, ces modules offrent un éventail infini de possibilités.

Les modules sonores **PIPS** offrent un niveau sonore réglable de 65 dB à 115 dB. Le rendement des modules lumineux est également variable. Le système PIPS offre ainsi une solution appropriée pour toute application imaginable. Nos spécialistes se feront un plaisir de vous aider à faire les bons choix. 4K vous propose d'ores et déjà le sommaire suivant:



**PIPS** biedt 5 innovatieve basissen in 4 verschillende spanningen en 4 diverse kleuren. Dit geeft de gebruiker 58 verschillende opties naargelang zijn benodigdheden: een perfecte oplossing voor elke toepassing.

Le système **PIPS** compte 5 bases et 4 plages de tension différentes et 4 coloris différents. Ceci offre à l'utilisateur 58 options différentes en fonction de ses besoins: une solution parfaite pour chaque application.

### PB100

De basis **PB100** (laag), verkrijgbaar in 12-24 Vac/dc is de ideale keuze voor alle standaardtoepassingen of waar een compacte installatie noodzakelijk is. De bedrading wordt aan de onderkant van de basis aangesloten.

La base **PB100** (basse), disponible en 12-24 Vac/dc, représente le choix idéal pour toutes les applications impliquant des zones de montage planes ou nécessitant une installation compacte. Le câblage est connecté à la face inférieure de la base.

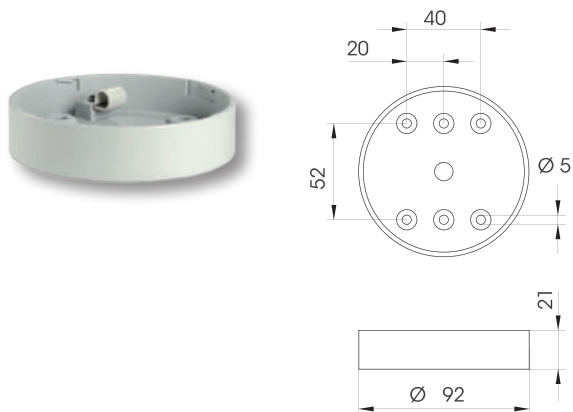

artikel article	spanning tension		kleur * couleur		
PB101	12-24 Vac/dc	± 10%	 RAL 7035	60 gr	1

\* op aanvraag / sur demande  
zwart/noir (RAL 9005) - rood/rouge (RAL 3000) - wit/blanc (RAL 9003)



### PB200

De basis **PB200** (hoog), verkrijgbaar in 12-24 Vac/dc, 40-80 Vac/dc, 120-240 Vac en PNP 12-24 Vdc, biedt de mogelijkheid om 2 M20 wartels aan de zijkant van de basis te monteren. Dit is de ideale oplossing wanneer de bedrading niet onderaan maar via de zijkant van de basis aangesloten moet worden. Ook installaties in serie kunnen hiermee perfect worden gerealiseerd.

La base **PB200** (haute), disponible en 12-24 Vac/dc, 40-80 Vac/dc, 120-240 Vac et PNP 12-24 Vdc, offre la possibilité de monter 2 presse-étoupes M20 sur les faces latérales de la base. Il s'agit de la solution idéale lorsque le câblage ne doit pas être connecté par la face inférieure, mais par la face latérale de la base. La base permet aussi la réalisation d'installations en série.

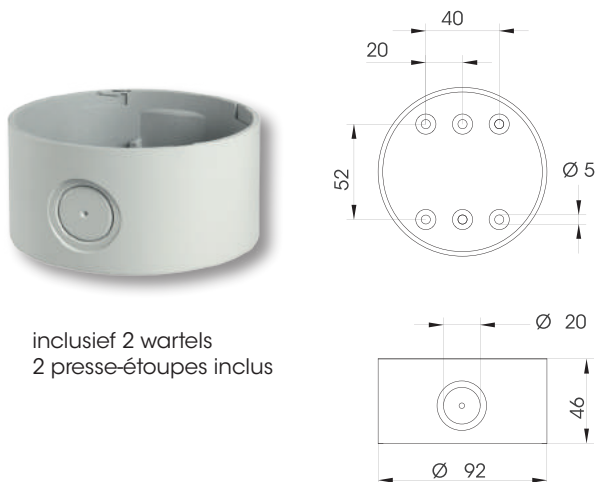

inclusief 2 wartels  
2 presse-étoupes inclus

artikel article	spanning tension		kleur * couleur		
PB201	12-24 Vac/dc	± 10%	 RAL 7035	120 gr	1
PB202	40-80 Vac/dc	± 10%	 RAL 7035	170 gr	1
PB203	120-240 Vac	± 10%	 RAL 7035	170 gr	1
PB204	PNP 12-24 Vdc	± 10%	 RAL 7035	120 gr	1

\* op aanvraag / sur demande  
zwart/noir (RAL 9005) - rood/rouge (RAL 3000) - wit/blanc (RAL 9003)





**PB300**

De basis **PB300** (verticale montage), verkrijgbaar in 12-24 Vac/dc, 40-80 Vac/dc, 90/240 Vac en PNP 12-24 Vdc, is de ideale keuze voor installaties tegen muren of wanden. De veelzijdigheid van deze basis wordt benadrukt door 4 kabelingangen (2 onderaan en 2 achteraan).

La base **PB300** (fixation verticale), disponible en 12-24 Vac/dc, 40-80 Vac/dc, 120-240 Vac et PNP 12-24 Vdc, représente le choix idéal pour une installation contre un mur ou une paroi. La polyvalence de cette base est mise en évidence par 4 entrées de câble (2 par la face inférieure, 2 par la face latérale).

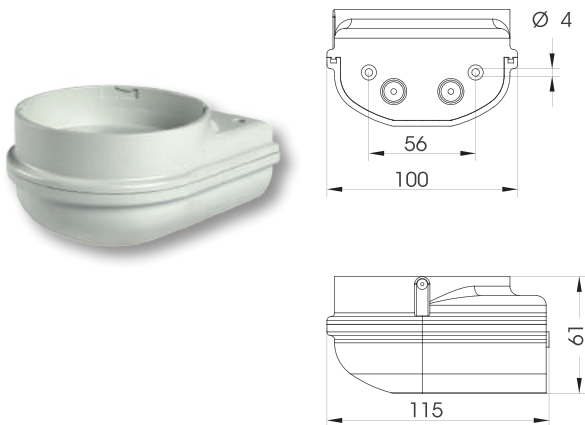

artikel article	spanning tension		kleur * couleur		
PB301	12-24 Vac/dc	± 10%	 RAL 7035	190 gr	1
PB302	40-80 Vac/dc	± 10%	 RAL 7035	240 gr	1
PB303	120-240 Vac	± 10%	 RAL 7035	240 gr	1
PB304	PNP 12-24 Vdc	± 10%	 RAL 7035	190 gr	1

\* op aanvraag / sur demande  
zwart/noir (RAL 9005) - rood/rouge (RAL 3000) - wit/blanc (RAL 9003)



**PB400**

De dubbele basis **PB400** (verticale montage), verkrijgbaar in 12-24 Vac/dc, 40-80 Vac/dc, 90/240 Vac en PNP 12-24 Vdc, geeft de mogelijkheid om 2 verschillende modules van PIPS in 1 oplossing te installeren. Zo kunnen unieke akoestische en visuele combinaties gemaakt worden. Dit is een mooi voorbeeld van de multifunctionaliteit van het PIPS gamma.

La double base **PB400** (fixation verticale), disponible en 12-24 Vac/dc, 40-80 Vac/dc, 120-240 Vac et PNP 12-24 Vdc, offre la possibilité d'installer 2 modules PIPS différents en 1 solution. Il est ainsi possible de réaliser des combinaisons acoustiques et visuelles absolument uniques. C'est là un bel exemple de la multifonctionnalité de la gamme PIPS.

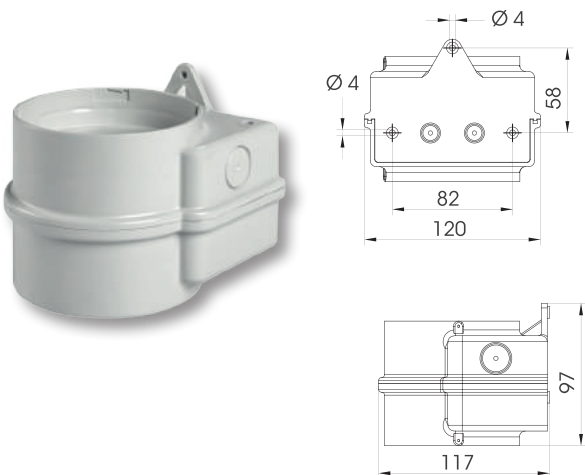

artikel article	spanning tension		kleur * couleur		
PB401	12-24 Vac/dc	± 10%	 RAL 7035	260 gr	1
PB402	40-80 Vac/dc	± 10%	 RAL 7035	350 gr	1
PB403	120-240 Vac	± 10%	 RAL 7035	350 gr	1
PB404	PNP 12-24 Vdc	± 10%	 RAL 7035	260 gr	1

\* op aanvraag / sur demande  
zwart/noir (RAL 9005) - rood/rouge (RAL 3000) - wit/blanc (RAL 9003)



**PB500**

De basis **PB500** (inbouduitvoering), verkrijgbaar in 12-24V AC/DC, 40-80 Vac/dc en 120-240 Vac, is de ideale oplossing voor montage in bijvoorbeeld valse plafonds. Deze basis garandeert een gemakkelijke en onopvallende installatie, geschikt voor alle situaties waar ook esthetische normen gelden zoals in openbare ruimtes en bij commerciële toepassingen.

La base **PB500** (version encastrée), disponible en 12-24 Vac/dc, 40-80 Vac/dc et 120-240 Vac, est la solution idéale pour un montage dans un faux plafond, par exemple. Cette base garantit une installation aisée et discrète, appropriée pour toutes les situations soumises à des normes esthétiques, comme les espaces publics et les applications commerciales.

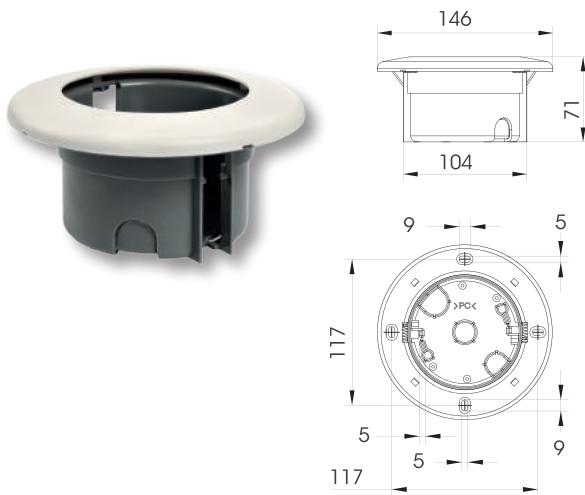

artikel article	spanning tension		kleur * couleur		
PB501	12-24 Vac/dc	± 10%	 RAL 9003	220 gr	1
PB502	40-80 Vac/dc	± 10%	 RAL 9003	270 gr	1
PB503	120-240 Vac	± 10%	 RAL 9003	270 gr	1

\* op aanvraag / sur demande  
rood/rouge (RAL 3000)

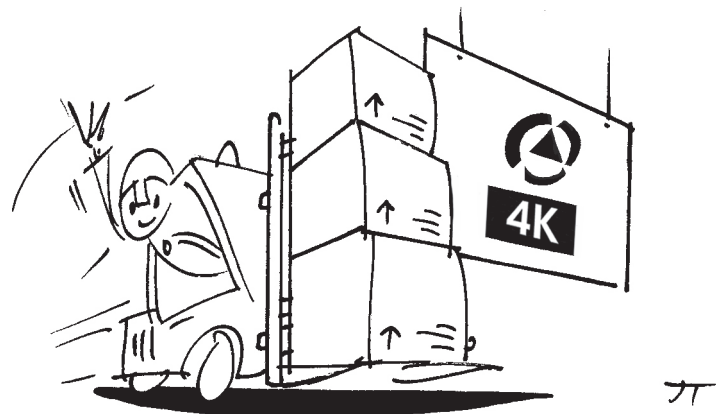

▲ PIPS - Multifunctionele LED signalisatie  
 ▲ PIPS - Signalisation à LED multifonctionnelle



PL100



**PL100** is een multifunctioneel LED toestel met een hoge lichtoutput. Door gebruik te maken van de 'multi-channel' technologie, kan u verschillende lichteffecten kiezen en beheren.

- ▲ niveau 1: continu branden
- ▲ niveau 2: knipperlicht
- ▲ niveau 3: roterend licht

Appareil LED multifonction à rendement lumineux élevé. Grâce à l'usage de la technologie 'multi-channel', vous êtes en mesure de choisir et de gérer différents effets lumineux.

- ▲ niveau 1: éclairage en continu
- ▲ niveau 2: éclairage clignotant
- ▲ niveau 3: éclairage rotatif



artikel article	kleur couleur		
PL101	on  off	200 gr	1
PL102	on  off	200 gr	1
PL103	on  off	200 gr	1
PL104	on  off	200 gr	1
PL105	on  off	200 gr	1

artikel article	kleur couleur		
PL106	on  off	200 gr	1
PL107	on  off	200 gr	1
PL108	on  off	200 gr	1
PL109	on  off	200 gr	1

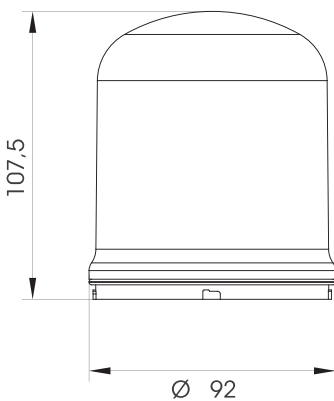

spanning tension	basissen - bases				
12-24 Vac/dc	PB101	PB201	PB301	PB401	PB501
40-80 Vac/dc	-	PB202	PB302	PB402	PB502
120-240 Vac	-	PB203	PB303	PB403	PB503
PNP 12-24 Vdc	-	PB204	PB304	PB404	-

**PL200**



**PL200** is een multifunctioneel LED toestel met een hoge lichtoutput. Door gebruik te maken van de 'multi-channel' technologie, kan u verschillende lichteffecten kiezen en beheren.

- ▲ niveau 1: knipperlicht
- ▲ niveau 2: stroboscopisch effect
- ▲ niveau 3: random effect

Appareil LED multifonction à rendement lumineux élevé. Grâce à l'usage de la technologie 'multi-channel', vous êtes en mesure de choisir et de gérer différents effets lumineux.

- ▲ niveau 1: éclairage clignotant
- ▲ niveau 2: effet stroboscopique
- ▲ niveau 3: effet random



artikel article	kleur couleur		
PL201	on  off	200 gr	1
PL202	on  off	200 gr	1
PL203	on  off	200 gr	1
PL204	on  off	200 gr	1
PL205	on  off	200 gr	1

artikel article	kleur couleur		
PL206	on  off	200 gr	1
PL207	on  off	200 gr	1
PL208	on  off	200 gr	1
PL209	on  off	200 gr	1

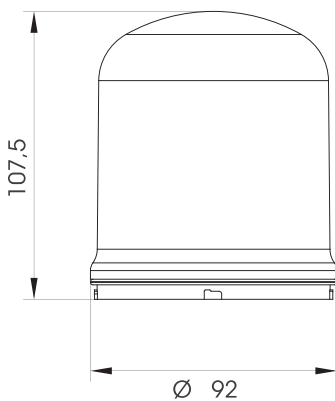

spanning tension	basissen - bases				
12/24 Vac/dc	PB101	PB201	PB301	PB401	PB501
40-80 Vac/dc	-	PB202	PB302	PB402	PB502
120-240 Vac	-	PB203	PB303	PB403	PB503
PNP 12/24 Vdc	-	PB204	PB304	PB404	-

**PL301**



Multifunctioneel LED toestel dat aan de meest veeleisende toepassingen voldoet. Door toepassing van de 'multi-channel' technologie kunnen er 3 verschillende alarmniveaus ingesteld worden. Per alarmniveau heeft u de keuze uit 8 verschillende kleuren en 5 verschillende lichteffecten. **PL301** is voorzien van een **opale lens** voor 'korte-afstand' signalisatie.

- ▲ kleuren: wit, oranje, geel, rood, cyaan, groen, magenta, blauw
- ▲ lichteffecten: continu branden, enkele flits, dubbele flits, stroboscopisch en random effect.

Appareil LED multifonction qui répond aux applications les plus exigeantes. Grâce à l'application de la technologie 'multi-channel', il est possible de programmer 3 niveaux d'alarme différents. Par niveau d'alarme, vous avez le choix parmi 8 coloris différents et 5 effets lumineux différents. Le système **PL301** est équipé d'une **lentille opaline** pour une signalisation 'à courte distance'.

- ▲ coloris: blanc, orange, jaune, rouge, cyan, vert, magenta, bleu
- ▲ effets lumineux: éclairage en continu, simple flash, double flash, effet stroboscopique et effet aléatoire

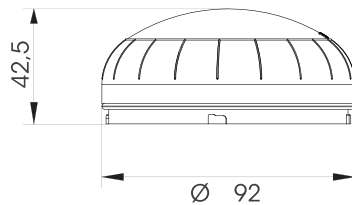

artikel article	functie fonction		
PL301	kennisgeven notifier	90 gr	1



spanning tension	basissen - bases				
12-24 Vac/dc	PB101	PB201	PB301	PB401	PB501
40-80 Vac/dc	-	PB202	PB302	PB402	PB502
120-240 Vac	-	PB203	PB303	PB403	PB503
PNP 12-24 Vdc	-	PB204	PB304	PB404	-

**PL302**



Multifunctioneel LED toestel dat aan de meest veeleisende toepassingen voldoet. Door toepassing van de 'multi-channel' technologie kunnen er 3 verschillende alarmniveaus ingesteld worden. Per alarmniveau heeft u de keuze uit 8 verschillende kleuren en 5 verschillende lichteffecten. **PL302** is voorzien van een **fresnel lens** voor 'lange-afstand' signalisatie.

- ▲ kleuren: wit, oranje, geel, rood, cyaan, groen, magenta, blauw
- ▲ lichteffecten: continu branden, enkele flits, dubbele flits, stroboscopisch en random effect.

Appareil LED multifonction qui répond aux applications les plus exigeantes. Grâce à l'application de la technologie 'multi-channel', il est possible de programmer 3 niveaux d'alarme différents. Par niveau d'alarme, vous avez le choix parmi 8 coloris différents et 5 effets lumineux différents. Le système **PL302** est équipé d'une **lentille de fresnel** pour une signalisation 'à longue distance'.

- ▲ coloris: blanc, orange, jaune, rouge, cyan, vert, magenta, bleu
- ▲ effets lumineux: éclairage en continu, simple flash, double flash, effet stroboscopique et effet aléatoire

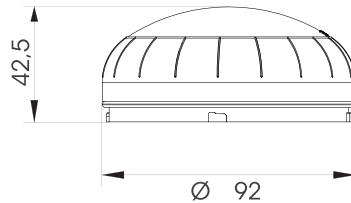

artikel article	functie fonction		
PL302	waarschuwen avertir	90 gr	1



spanning tension	basissen - bases				
12-24 Vac/dc	PB101	PB201	PB301	PB401	PB501
40-80 Vac/dc	-	PB202	PB302	PB402	PB502
120-240 Vac	-	PB203	PB303	PB403	PB503
PNP 12-24 Vdc	-	PB204	PB304	PB404	-



**PS100**



**PS100** is een multifunctionele sirene met hoge geluidskwaliteit. Door de 'multi-channel' technologie kunnen er 2 verschillende alarmniveaus ingesteld worden. Per alarmniveau geeft de **PS100** u de mogelijkheid te kiezen uit 32 verschillende waarschuwingstonen.

- ▲ niveau 1: vrije keuze uit 32 tonen
- ▲ niveau 2: vrije keuze uit 32 tonen

regelbaar volume van 65 dB tot 105 dB

Sirène multifonctionnelle offrant une qualité de sonorisation élevée. Grâce à l'application de la technologie 'multi-channel', il est possible de programmer 2 niveaux d'alarme différents. Par niveau d'alarme, le modèle **PS100** vous offre le choix parmi 32 tonalités d'avertissement différentes.

- ▲ niveau 1: choix libre de 32 tonalités
- ▲ niveau 2: choix libre de 32 tonalités

volume réglable de 65 dB à 105 dB

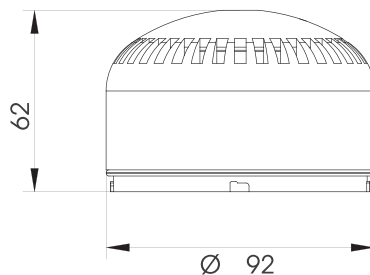

artikel article	kleur * couleur		
PS101	 RAL 7035	220 gr	1

\* ook verkrijgbaar in zwart, rood en wit  
 aussi disponible en noir, rouge et blanc



spanning tension	basissen - bases				
12-24 Vac/dc	PB101	PB201	PB301	PB401	PB501
40-80 Vac/dc	-	PB202	PB302	PB402	PB502
120-240 Vac	-	PB203	PB303	PB403	PB503
PNP 12-24 Vdc	-	PB204	PB304	PB404	-

- ▲ PIPS - Multifunctionele geluidssignalisatie
- ▲ PIPS - Signalisation sonore multifonctionnelle



**PS200**



**PS200** is een multifunctionele sirene met hoge geluidskwaliteit. Door de 'multi-channel' technologie kunnen er 2 verschillende alarmniveaus ingesteld worden. **PS200** is de grote broer (+10 dB) van de PS100 en geeft u per alarmniveau eveneens de mogelijkheid te kiezen uit 32 verschillende waarschuwingstonen.

- ▲ niveau 1: vrije keuze uit 32 tonen
- ▲ niveau 2: vrije keuze uit 32 tonen

regelbaar volume van 65 dB tot **115 dB**

Sirène multifonctionnelle offrant une qualité de sonorisation élevée. Grâce à l'application de la technologie 'multi-channel', il est possible de programmer 2 niveaux d'alarme différents. Le modèle **PS200** est le grand frère (+10 dB) du modèle PS100 et vous donne également par niveau d'alarme le choix parmi 32 tonalités d'avertissement différentes.

- ▲ niveau 1: choix libre de 32 tonalités
- ▲ niveau 2: choix libre de 32 tonalités

volume réglable de 65 dB à **115 dB**

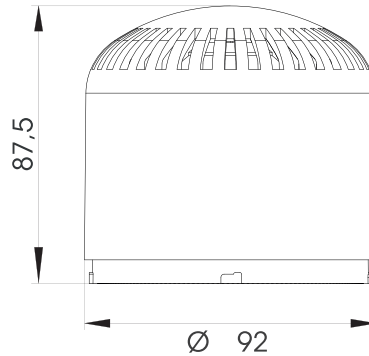

artikel article	kleur * couleur		
PS201	 RAL 7035	540 gr	1

\* ook verkrijgbaar in zwart, rood en wit  
aussi disponible en noir, rouge et blanc



spanning tension	basissen - bases				
12-24 Vac/dc	PB101	PB201	PB301	PB401	PB501
40-80 Vac/dc	-	PB202	PB302	PB402	PB502
120-240 Vac	-	PB203	PB303	PB403	PB503
PNP 12-24 Vdc	-	PB204	PB304	PB404	-

- ▲ PIPS - Multifunctionele toestellen: GELUID en LED
- ▲ PIPS - Des appareils multifonctionnels: SON et LED



**PLS100**



**PLS100** is de eerste module uit het PIPS gamma dat akoestische én visuele signalisatie combineert. Door de 'multi-channel' technologie kunnen er 3 verschillende alarmniveaus beheerd worden.

- ▲ niveau 1: visueel stroboscopisch effect
- ▲ niveau 2: visueel stroboscopisch effect met waarschuwingston (vrije keuze uit 32 tonen)
- ▲ niveau 3: continu branden met waarschuwingston (vrije keuze uit 32 tonen)

regelbaar volume van 65 dB tot 105 dB

Le **PLS100** est le premier module de la gamme PIPS à combiner une signalisation acoustique et visuelle. Grâce à l'application de la technologie 'multi-channel', il est possible de consigner 3 niveaux d'alarme différents.

- ▲ niveau 1: effet stroboscopique visuel
- ▲ niveau 2: effet stroboscopique visuel avec tonalité d'avertissement (choix libre de 32 tonalités)
- ▲ niveau 3: éclairage en continu avec tonalité d'avertissement (choix libre de 32 tonalités)

volume réglable de 65 dB à 105 dB

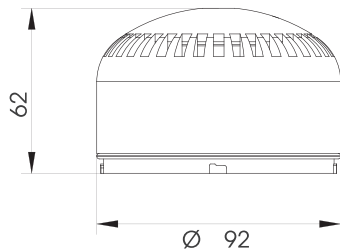

artikel article	kleur couleur		
PLS101		220 gr	1
PLS102		220 gr	1
PLS103		220 gr	1
PLS104		220 gr	1
PLS105		220 gr	1



spanning tension	basissen - bases				
12-24 Vac/dc	PB101	PB201	PB301	PB401	PB501
40-80 Vac/dc	-	PB202	PB302	PB402	PB502
120-240 Vac	-	PB203	PB303	PB403	PB503
PNP 12-24 Vdc	-	PB204	PB304	PB404	-

- ▲ PIPS - Multifunctionele toestellen: GELUID en LED
- ▲ PIPS - Des appareils multifonctionnels: SON et LED



**PLS200**



**PLS200** is de grote broer (+10 dB) van de PLS100 dat eveneens akoestische én visuele signalisatie combineert. Door de 'multi-channel' technologie kunnen er 3 verschillende alarmniveaus beheerd worden.

- ▲ niveau 1: visueel stroboscopisch effect
- ▲ niveau 2: visueel stroboscopisch effect met waarschuwingston (vrije keuze uit 32 tonen)
- ▲ niveau 3: continu branden met waarschuwingston (vrije keuze uit 32 tonen)

regelbaar volume van 65 dB tot **115 dB**

Le **PLS200** est le grand frère (+10 dB) du modèle PLS100 qui permet également de combiner une signalisation acoustique et visuelle. Grâce à l'application de la technologie 'multi-channel', il est possible de consigner 3 niveaux d'alarme différents.

- ▲ niveau 1: effet stroboscopique visuel
- ▲ niveau 2: effet stroboscopique visuel avec tonalité d'avertissement (choix libre de 32 tonalités)
- ▲ niveau 3: éclairage en continu avec tonalité d'avertissement (choix libre de 32 tonalités)

volume réglable de 65 dB à **115 dB**

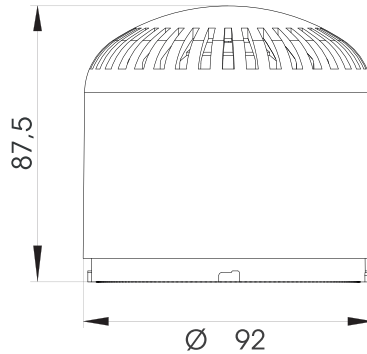

artikel article	kleur couleur		
PLS201		540 gr	1
PLS202		540 gr	1
PLS203		540 gr	1
PLS204		540 gr	1
PLS205		540 gr	1



spanning tension	basissen - bases				
12-24 Vac/dc	PB101	PB201	PB301	PB401	PB501
40-80 Vac/dc	-	PB202	PB302	PB402	PB502
120-240 Vac	-	PB203	PB303	PB403	PB503
PNP 12-24 Vdc	-	PB204	PB304	PB404	-

- ▲ PIPS - Multifunctionele LED lichtsignalisatie
- ▲ PIPS - Signalisation à LED multifonctionnelle

**P I P S**

**PFL100**



LED signalisatiemodule met een hoge lichtoutput (knipperlicht) en **gecertificeerd volgens EN54-23** (alleen de witte versie - PFL102). **PFL100** is de ideale keuze voor een oplossing waarbij visibiliteit belangrijk is, meer bepaald op lange afstand (fresnel lens).

Module de signalisation LED à rendement d'éclairage élevé (éclairage clignotant) et **certifié selon la norme EN54-23** (uniquement la version blanche - PFL102). La version **PFL100** est le choix idéal pour une solution où la visibilité est importante, plus précisément à une longue distance (lentille fresnel).

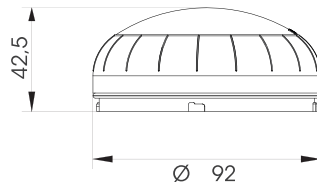

artikel article	kleur couleur		
PFL101		110 gr	1
PFL102		110 gr	1



PFL102



spanning tension	basissen - bases				
12-24 Vac/dc	PB101	PB201	PB301	PB401	PB501
PNP 12-24 Vdc	-	PB204	PB304	PB404	-

- ▲ PIPS - Multifunctionele LED lichtsignalisatie
- ▲ PIPS - Signalisation à LED multifonctionnelle

**P I P S**

**PFL200**



LED signalisatiemodule met een hoge lichtoutput (knipperlicht) en **gecertificeerd volgens EN54-23** (alleen de witte versie - PFL202). **PFL200** is de ideale keuze voor een oplossing waarbij visibiliteit belangrijk is (directionele lens).

Module de signalisation LED à rendement d'éclairage élevé (éclairage clignotant) et **certifié selon la norme EN54-23** (uniquement la version blanche - PFL202). La version **PFL200** est le choix idéal pour une solution où la visibilité est importante (lentille directionelle).

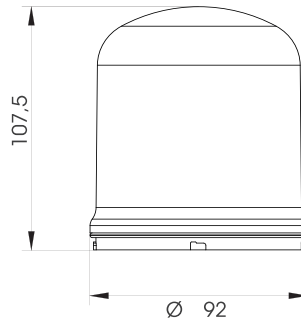

artikel article	kleur couleur		
PFL201		200 gr	1
PFL202		200 gr	1



PFL202



spanning tension	basissen - bases				
12-24 Vac/dc	PB101	PB201	PB301	PB401	PB501
PNP 12-24 Vdc	-	PB204	PB304	PB404	-



- ▲ PIPS - Multifunctionele geluidssignalisatie
- ▲ PIPS - Signalisation sonore multifonctionnelle

**P I P S**

**PFS100**



Multifunctionele sirene (**EN54-3 gecertificeerd**) met een hoge geluidskwaliteit. Door toepassing van de 'multi-channel' technologie kunnen er 2 verschillende alarmniveaus ingesteld worden.

- ▲ niveau 1: vrije keuze uit 12 verschillende **EN54-3 gecertificeerde** alarmtonen
- ▲ niveau 2: 'steady tone' alarm (PFEER TOXIC GAS)

regelbaar volume tot 100 dB

Sirène multifonctionnelle (**certifiée selon la norme EN54-3**) offrant une qualité de sonorisation élevée. L'application de la technologie 'multi-channel' permet la programmation de 2 niveaux d'alarme différents.

- ▲ niveau 1: choix libre de 12 tonalités d'alarme **certifiées EN54-3**
- ▲ niveau 2: alarme 'steady tone' (PFEER TOXIC GAS)

volume réglable jusqu'à 100 dB

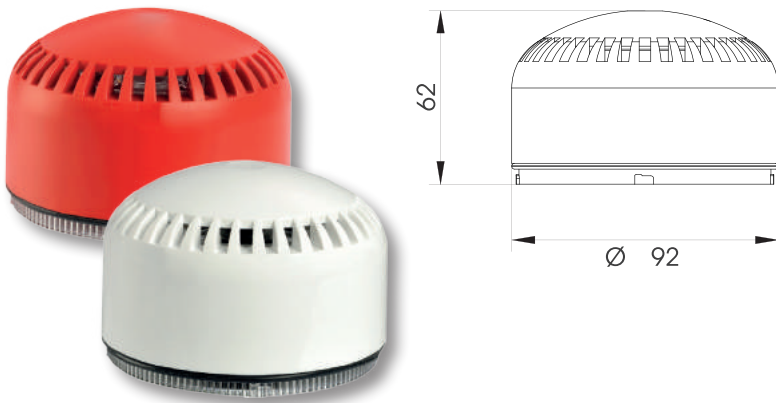

artikel article	kleur couleur		
PFS101		200 gr	1
PFS102		200 gr	1



spanning tension	basissen - bases				
12-24 Vac/dc	PB101	PB201	PB301	PB401	PB501
PNP 12-24 Vdc	-	PB204	PB304	PB404	-

- ▲ PIPS - Multifunctionele toestellen: GELUID en LED
- ▲ PIPS - Des appareils multifonctionnels: SON et LED



**PFLS100**



**PFLS100** is een akoestische én visuele signalisatiemodule (geluid én licht), **EN54-3 gecertificeerd**. Door de 'multi-channel' technologie kunnen er 2 verschillende alarmniveaus ingesteld worden. De alarmtonen kunnen op beide niveaus gecombineerd worden met een stroboscopisch lichteffect.

- ▲ niveau 1: vrije keuze uit 12 verschillende **EN54-3 gecertificeerde** alarmtonen
- ▲ niveau 2: 'steady tone' alarm (PFEER TOXIC GAS)

regelbaar volume tot 100 dB

Module de signalisation acoustique et visuel (son et lumière), **certifié EN54-3**. L'application de la technologie 'multi-channel' permet la consigne de 2 niveaux d'alarme différents. Les tonalités d'alarme peuvent être combinées avec un effet lumineux stroboscopique aux deux niveaux.

- ▲ niveau 1: choix libre de 12 tonalités d'alarme **certifiées EN54-3**
- ▲ niveau 2: alarme 'steady tone' (PFEER TOXIC GAS)

volume réglable jusqu'à 100 dB

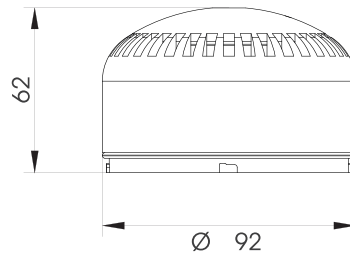

artikel article	kleur couleur		
PFLS101		200 gr	1
PFLS102		200 gr	1





























spanning tension	basissen - bases				
12-24 Vac/dc	PB101	PB201	PB301	PB401	PB501
PNP 12-24 Vdc	-	PB204	PB304	PB404	-

**PG100**

Maak zeker gebruik van onderstaand overzicht om het juiste beschermingsrooster te selecteren.

Faire usage du résumé ci-dessous pour sélectionner la grille de protection correcte.

type	compatibel met - compatible avec	
 67 mm PG101	 PB100	 PL300 / PFL100
	+	
	 PB100	 PS100 / PFS100
	+	
	 PB100	 PLS100 / PFLS100
	+	
	 PB200	 PL300 / PFL100
	+	
	 PB100	 PS200
	+	
	 PB100	 PLS200
	+	
	 PB200	 PS100 / PFS100
	+	
	 PB200	 PLS100 / PFLS100
	+	

type	compatibel met - compatible avec	
 135 mm PG104	 PB100	 PL100 / PL200 PFL200
	+	
	 PB200	 PS200
	+	
	 PB200	 PLS200
	+	
	 PB200	 PL100 / PL200 PFL200
	+	

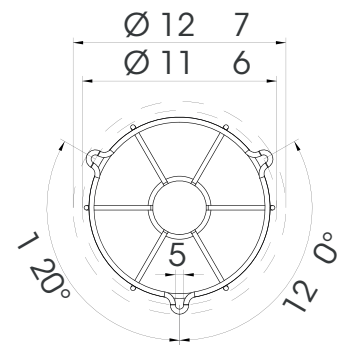

- ▲ Xenon en LED bakens
- ▲ Feux flash xénon et LED



**LP**

Xenon  
Xénon

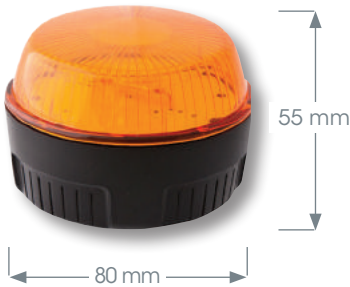

artikel article	vermogen puissance	spanning tension	kleur couleur	kenmerk caractéristique		
30102170	2W	multi voltage 10-100 Vdc/20-72 Vac		enkele blits flash simple	IP67	1
30102270	2W	multi voltage 10-100 Vdc/20-72 Vac		enkele blits flash simple	IP67	1
30102370	2W	multi voltage 10-100 Vdc/20-72 Vac		enkele blits flash simple	IP67	1
30102470	2W	multi voltage 10-100 Vdc/20-72 Vac		enkele blits flash simple	IP67	1
30102570	2W	multi voltage 10-100 Vdc/20-72 Vac		enkele blits flash simple	IP67	1
30102172	2W	230 Vac 207-253 Vac		enkele blits flash simple	IP67	1
30102272	2W	230 Vac 207-253 Vac		enkele blits flash simple	IP67	1
30102372	2W	230 Vac 207-253 Vac		enkele blits flash simple	IP67	1
30102472	2W	230 Vac 207-253 Vac		enkele blits flash simple	IP67	1
30102572	2W	230 Vac 207-253 Vac		enkele blits flash simple	IP67	1
30105170	5W	multi voltage 10-100 Vdc/20-72 Vac		enkele blits flash simple	IP67	1
30105270	5W	multi voltage 10-100 Vdc/20-72 Vac		enkele blits flash simple	IP67	1
30105370	5W	multi voltage 10-100 Vdc/20-72 Vac		enkele blits flash simple	IP67	1
30105470	5W	multi voltage 10-100 Vdc/20-72 Vac		enkele blits flash simple	IP67	1
30105570	5W	multi voltage 10-100 Vdc/20-72 Vac		enkele blits flash simple	IP67	1

Ook beschikbaar in LED uitvoering - zie pagina 31  
Aussi disponible en version LED - voir page 31

▲ Xenon en LED bakens  
▲ Feux flash xénon et LED



**LT** Xenon  
Xénon



artikel article	vermogen puissance	spanning tension	kleur couleur	kenmerk caractéristique		
31102170	2W	multi voltage 10-100 Vdc/20-72 Vac		enkele blits flash simple	IP67	1
31102270	2W	multi voltage 10-100 Vdc/20-72 Vac		enkele blits flash simple	IP67	1
31102370	2W	multi voltage 10-100 Vdc/20-72 Vac		enkele blits flash simple	IP67	1
31102470	2W	multi voltage 10-100 Vdc/20-72 Vac		enkele blits flash simple	IP67	1
31102570	2W	multi voltage 10-100 Vdc/20-72 Vac		enkele blits flash simple	IP67	1
31105172	5W	230 Vac 207-253 Vac		enkele blits flash simple	IP67	1
31105272	5W	230 Vac 207-253 Vac		enkele blits flash simple	IP67	1
31105372	5W	230 Vac 207-253 Vac		enkele blits flash simple	IP67	1
31105472	5W	230 Vac 207-253 Vac		enkele blits flash simple	IP67	1
31105572	5W	230 Vac 207-253 Vac		enkele blits flash simple	IP67	1
31105170	5W	multi voltage 10-100 Vdc/20-72 Vac		enkele blits flash simple	IP67	1
31105270	5W	multi voltage 10-100 Vdc/20-72 Vac		enkele blits flash simple	IP67	1
31105370	5W	multi voltage 10-100 Vdc/20-72 Vac		enkele blits flash simple	IP67	1
31105470	5W	multi voltage 10-100 Vdc/20-72 Vac		enkele blits flash simple	IP67	1
31105570	5W	multi voltage 10-100 Vdc/20-72 Vac		enkele blits flash simple	IP67	1

Ook beschikbaar in LED uitvoering - zie pagina 31  
Aussi disponible en version LED - voir page 31

- ▲ Xenon en LED bakens
- ▲ Feux flash xénon et LED



**LP**



artikel article	spanning tension	kleur couleur	kenmerk caractéristique		
445002	multi voltage 10-100 Vdc/20-72 Vac		flashing/steady	IP67	1
445003	multi voltage 10-100 Vdc/20-72 Vac		flashing/steady	IP67	1
447002	230 Vac 85 - 256 Vac		flashing/steady	IP67	1
447003	230 Vac 85 - 256 Vac		flashing/steady	IP67	1

**LT**



artikel article	spanning tension	kleur couleur	kenmerk caractéristique		
446002	multi voltage 10-100 Vdc/20-72 Vac		flashing/steady	IP67	1
446003	multi voltage 10-100 Vdc/20-72 Vac		flashing/steady	IP67	1
448002	230 Vac 85 - 256 Vac		flashing/steady	IP67	1
448003	230 Vac 85 - 256 Vac		flashing/steady	IP67	1

**MX**



artikel article	spanning tension	kleur couleur	kenmerk caractéristique		
446052	multi voltage 10-100 Vdc		multi blits flash multiples	IP65	1
446053	multi voltage 10-100 Vdc		multi blits flash multiples	IP65	1
448052	110/230 V 85 - 265 Vac		multi blits flash multiples	IP65	1



- ▲ Xenon en LED bakens
- ▲ Feux flash xénon et LED



**RB4** Xenon - 6W  
Xénon - 6W



artikel article	spanning tension	kleur couleur	kenmerk caractéristique		
468012	12/24 Vdc 10-32 Vdc		enkele blits flash simple	IP65	1
468014	12/24 Vdc 10-32 Vdc		enkele blits flash simple	IP65	1

**RB3** Xenon - 10W  
Xénon - 10W



artikel article	spanning tension	kleur couleur	kenmerk caractéristique		
408051	230 Vac 207-253 Vac		enkele blits flash simple	IP65	1
408052	230 Vac 207-253 Vac		enkele blits flash simple	IP65	1
408053	230 Vac 207-253 Vac		enkele blits flash simple	IP65	1
408054	230 Vac 207-253 Vac		enkele blits flash simple	IP65	1
408055	230 Vac 207-253 Vac		enkele blits flash simple	IP65	1

**RB2** Xenon - 15W  
Xénon - 15W















artikel article	spanning tension	kleur couleur	kenmerk caractéristique		
470001	12/24 Vdc 10-30 Vdc		enkele blits flash simple	IP65	1
470002	12/24 Vdc 10-30 Vdc		enkele blits flash simple	IP65	1
470003	12/24 Vdc 10-30 Vdc		enkele blits flash simple	IP65	1
470004	12/24 Vdc 10-30 Vdc		enkele blits flash simple	IP65	1
470005	12/24 Vdc 10-30 Vdc		enkele blits flash simple	IP65	1

- ▲ Xenon en LED bakens
- ▲ Feux flash xénon et LED

**EL** Xenon - 15W  
Xénon - 15W



artikel article	spanning tension	kleur couleur	kenmerk caractéristique		
470051	12/24 Vdc 11,5 - 30 Vdc		dubbele bliits flash double	IP65	1
470042	12/24 Vdc 11,5 - 30 Vdc		dubbele bliits flash double	IP65	1
470053	12/24 Vdc 11,5 - 30 Vdc		dubbele bliits flash double	IP65	1
470044	12/24 Vdc 11,5 - 30 Vdc		dubbele bliits flash double	IP65	1
470055	12/24 Vdc 11,5 - 30 Vdc		dubbele bliits flash double	IP65	1
423001	230 Vac 207-253 Vac		enkele bliits flash simple	IP65	1
423002	230 Vac 207-253 Vac		enkele bliits flash simple	IP65	1
423003	230 Vac 207-253 Vac		enkele bliits flash simple	IP65	1
423004	230 Vac 207-253 Vac		enkele bliits flash simple	IP65	1
423005	230 Vac 207-253 Vac		enkele bliits flash simple	IP65	1

**FX** Toebehoren  
Accessoires



FX9



FX14



FX40

artikel article	omschrijving description	LP	LT	RB	MX	EL	
FX9	beschermingsrooster / grille de protection			✓	✓		1
FX14	bevestigingsbeugel / support			✓	✓	✓	1
FX40	bevestigingsbeugel / support	✓	✓				1

▲ Optische en auditieve signalisatietoestellen  
 ▲ Appareils de signalisation optiques et auditifs



Auer Signal

QDS

Steady/flashing beacon

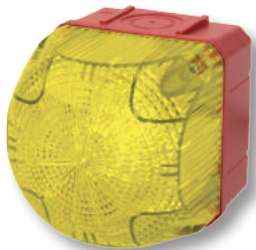

artikel article	spanning tension			stroom courant	temperatuur température	kleur couleur	
874161405	24 Vac/dc ± 10%	10 Cd	IP66	max. 0,11 A	-30° +60° C		1
874162405	24 Vac/dc ± 10%	10 Cd	IP66	max. 0,11 A	-30° +60° C		1
874164405	24 Vac/dc ± 10%	10 Cd	IP66	max. 0,11 A	-30° +60° C		1
874165405	24 Vac/dc ± 10%	10 Cd	IP66	max. 0,11 A	-30° +60° C		1
874166405	24 Vac/dc ± 10%	10 Cd	IP66	max. 0,11 A	-30° +60° C		1
874167405	24 Vac/dc ± 10%	10 Cd	IP66	max. 0,11 A	-30° +60° C		1
874161313	230/240 Vac ± 10%	10 Cd	IP66	max. 0,06 A	-30° +60° C		1
874162313	230/240 Vac ± 10%	10 Cd	IP66	max. 0,06 A	-30° +60° C		1
874164313	230/240 Vac ± 10%	10 Cd	IP66	max. 0,06 A	-30° +60° C		1
874165313	230/240 Vac ± 10%	10 Cd	IP66	max. 0,06 A	-30° +60° C		1
874166313	230/240 Vac ± 10%	10 Cd	IP66	max. 0,06 A	-30° +60° C		1
874167313	230/240 Vac ± 10%	10 Cd	IP66	max. 0,06 A	-30° +60° C		1

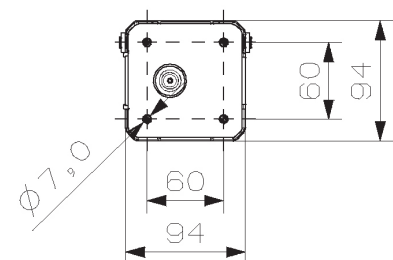
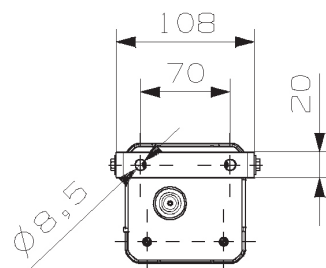
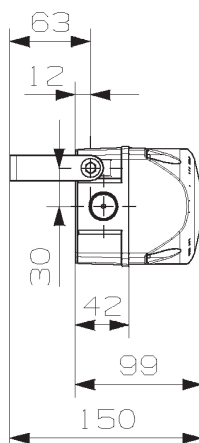

Beugel afzonderlijk te bestellen - zie pagina 40.  
 Veuillez commander le support séparément - voir page 40.

- ▲ Optische en auditieve signalisatietoestellen
- ▲ Appareils de signalisation optiques et auditifs



Auer Signal

**QDM**

Steady/flashing beacon



artikel article	spanning tension			stroom courant	temperatuur température	kleur couleur	
874261408	24-48 Vac/dc 16-60 Vdc, 16-53 Vac	120 Cd	IP66	max. 0,3 A	-30° +60° C		1
874262408	24-48 Vac/dc 16-60 Vdc, 16-53 Vac	120 Cd	IP66	max. 0,3 A	-30° +60° C		1
874264408	24-48 Vac/dc 16-60 Vdc, 16-53 Vac	120 Cd	IP66	max. 0,3 A	-30° +60° C		1
874265408	24-48 Vac/dc 16-60 Vdc, 16-53 Vac	120 Cd	IP66	max. 0,3 A	-30° +60° C		1
874266408	24-48 Vac/dc 16-60 Vdc, 16-53 Vac	120 Cd	IP66	max. 0,3 A	-30° +60° C		1
874267408	24-48 Vac/dc 16-60 Vdc, 16-53 Vac	120 Cd	IP66	max. 0,3 A	-30° +60° C		1
874261413	110-240 Vac/dc 80-265 Vac/dc	120 Cd	IP66	max. 0,07 A	-30° +60° C		1
874262413	110-240 Vac/dc 80-265 Vac/dc	120 Cd	IP66	max. 0,07 A	-30° +60° C		1
874264413	110-240 Vac/dc 80-265 Vac/dc	120 Cd	IP66	max. 0,07 A	-30° +60° C		1
874265413	110-240 Vac/dc 80-265 Vac/dc	120 Cd	IP66	max. 0,07 A	-30° +60° C		1
874266413	110-240 Vac/dc 80-265 Vac/dc	120 Cd	IP66	max. 0,07 A	-30° +60° C		1
874267413	110-240 Vac/dc 80-265 Vac/dc	120 Cd	IP66	max. 0,07 A	-30° +60° C		1

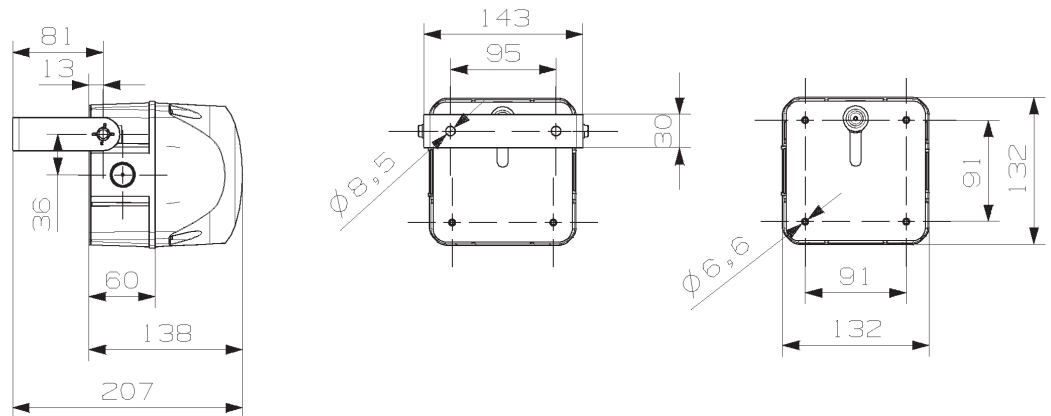

Beugel afzonderlijk te bestellen - zie pagina 40.  
Veuillez commander le support séparément - voir page 40.



sales@4K.be ▲ +32 9 253 20 48

▲ Optische en auditieve signalisatietoestellen  
 ▲ Appareils de signalisation optiques et auditifs



Auer Signal

QDL

Steady/flashing beacon



artikel article	spanning tension			stroom courant	temperatuur température	kleur couleur	
874361408	24-48 Vac/dc 16-60 Vdc, 16-53 Vac	170 Cd	IP66	max. 0,78 A	-30° +60° C		1
874362408	24-48 Vac/dc 16-60 Vdc, 16-53 Vac	170 Cd	IP66	max. 0,78 A	-30° +60° C		1
874364408	24-48 Vac/dc 16-60 Vdc, 16-53 Vac	170 Cd	IP66	max. 0,78 A	-30° +60° C		1
874365408	24-48 Vac/dc 16-60 Vdc, 16-53 Vac	170 Cd	IP66	max. 0,78 A	-30° +60° C		1
874366408	24-48 Vac/dc 16-60 Vdc, 16-53 Vac	170 Cd	IP66	max. 0,78 A	-30° +60° C		1
874367408	24-48 Vac/dc 16-60 Vdc, 16-53 Vac	170 Cd	IP66	max. 0,78 A	-30° +60° C		1
874361413	110-240 Vac/dc 80-265 Vac/dc	170 Cd	IP66	max. 0,21 A	-30° +60° C		1
874362413	110-240 Vac/dc 80-265 Vac/dc	170 Cd	IP66	max. 0,21 A	-30° +60° C		1
874364413	110-240 Vac/dc 80-265 Vac/dc	170 Cd	IP66	max. 0,21 A	-30° +60° C		1
874365413	110-240 Vac/dc 80-265 Vac/dc	170 Cd	IP66	max. 0,21 A	-30° +60° C		1
874366413	110-240 Vac/dc 80-265 Vac/dc	170 Cd	IP66	max. 0,21 A	-30° +60° C		1
874367413	110-240 Vac/dc 80-265 Vac/dc	170 Cd	IP66	max. 0,21 A	-30° +60° C		1

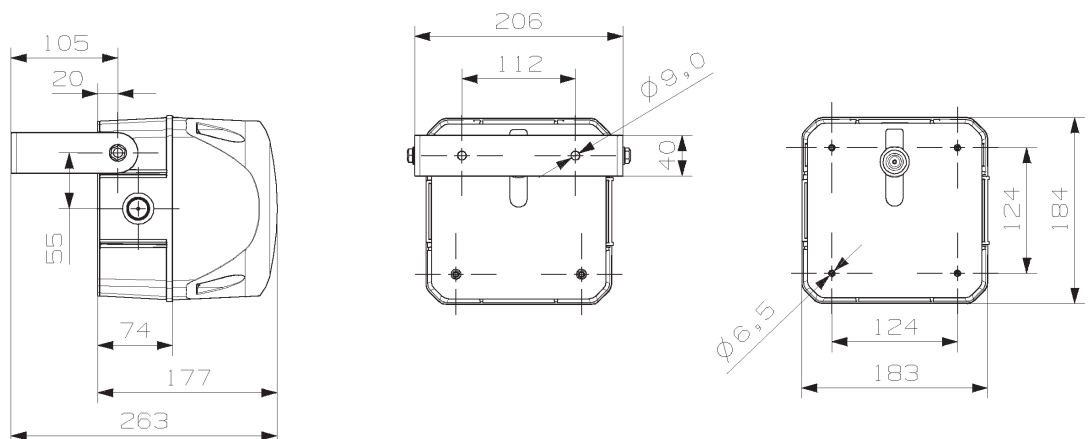

Beugel afzonderlijk te bestellen - zie pagina 40.  
 Veuillez commander le support séparément - voir page 40.

- ▲ Optische en auditieve signalisatietoestellen
- ▲ Appareils de signalisation optiques et auditifs



Auer Signal

**QDX**

Steady/flashing beacon

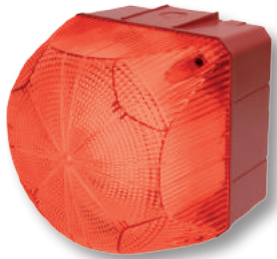

artikel article	spanning tension			stroom courant	temperatuur température	kleur couleur	
874461408	24-48 Vac/dc 16-60 Vdc, 16-53 Vac	300 Cd	IP66	max. 1,8 A	-30° +60° C		1
874462408	24-48 Vac/dc 16-60 Vdc, 16-53 Vac	300 Cd	IP66	max. 1,8 A	-30° +60° C		1
874464408	24-48 Vac/dc 16-60 Vdc, 16-53 Vac	300 Cd	IP66	max. 1,8 A	-30° +60° C		1
874465408	24-48 Vac/dc 16-60 Vdc, 16-53 Vac	300 Cd	IP66	max. 1,8 A	-30° +60° C		1
874466408	24-48 Vac/dc 16-60 Vdc, 16-53 Vac	300 Cd	IP66	max. 1,8 A	-30° +60° C		1
874467408	24-48 Vac/dc 16-60 Vdc, 16-53 Vac	300 Cd	IP66	max. 1,8 A	-30° +60° C		1
874461413	110-240 Vac/dc 80-265 Vac/dc	300 Cd	IP66	max. 0,35 A	-30° +60° C		1
874462413	110-240 Vac/dc 80-265 Vac/dc	300 Cd	IP66	max. 0,35 A	-30° +60° C		1
874464413	110-240 Vac/dc 80-265 Vac/dc	300 Cd	IP66	max. 0,35 A	-30° +60° C		1
874465413	110-240 Vac/dc 80-265 Vac/dc	300 Cd	IP66	max. 0,35 A	-30° +60° C		1
874466413	110-240 Vac/dc 80-265 Vac/dc	300 Cd	IP66	max. 0,35 A	-30° +60° C		1
874467413	110-240 Vac/dc 80-265 Vac/dc	300 Cd	IP66	max. 0,35 A	-30° +60° C		1

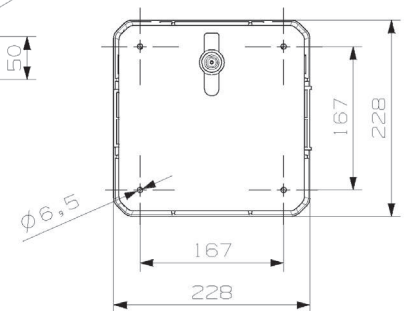
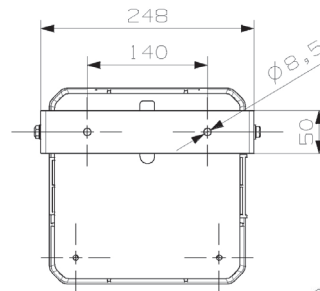
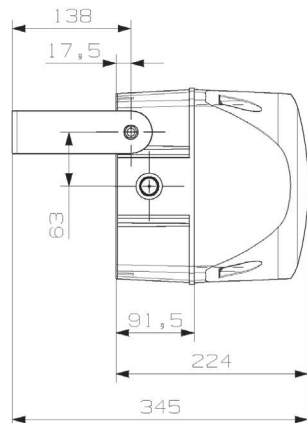

Beugel afzonderlijk te bestellen - zie pagina 40.  
Veuillez commander le support séparément - voir page 40.



sales@4K.be ▲ +32 9 253 20 48



▲ Optische en auditieve signalisatietoestellen  
▲ Appareils de signalisation optiques et auditifs



Auer Signal

QBL

Multi strobe beacon

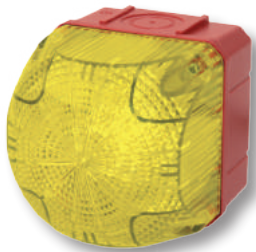

artikel article	spanning tension			stroom courant	temperatuur température	kleur couleur	
874761408	24-48 Vac/dc 16-60 Vdc, 16-53 Vac	250 Cd	IP66	max. 0,81 A	-30° +60° C		1
874762408	24-48 Vac/dc 16-60 Vdc, 16-53 Vac	250 Cd	IP66	max. 0,81 A	-30° +60° C		1
874764408	24-48 Vac/dc 16-60 Vdc, 16-53 Vac	250 Cd	IP66	max. 0,81 A	-30° +60° C		1
874765408	24-48 Vac/dc 16-60 Vdc, 16-53 Vac	250 Cd	IP66	max. 0,81 A	-30° +60° C		1
874766408	24-48 Vac/dc 16-60 Vdc, 16-53 Vac	250 Cd	IP66	max. 0,81 A	-30° +60° C		1
874767408	24-48 Vac/dc 16-60 Vdc, 16-53 Vac	250 Cd	IP66	max. 0,81 A	-30° +60° C		1
874761413	110-240 Vac/dc 80-265 Vac/dc	250 Cd	IP66	max. 0,22 A	-30° +60° C		1
874762413	110-240 Vac/dc 80-265 Vac/dc	250 Cd	IP66	max. 0,22 A	-30° +60° C		1
874764413	110-240 Vac/dc 80-265 Vac/dc	250 Cd	IP66	max. 0,22 A	-30° +60° C		1
874765413	110-240 Vac/dc 80-265 Vac/dc	250 Cd	IP66	max. 0,22 A	-30° +60° C		1
874766413	110-240 Vac/dc 80-265 Vac/dc	250 Cd	IP66	max. 0,22 A	-30° +60° C		1
874767413	110-240 Vac/dc 80-265 Vac/dc	250 Cd	IP66	max. 0,22 A	-30° +60° C		1

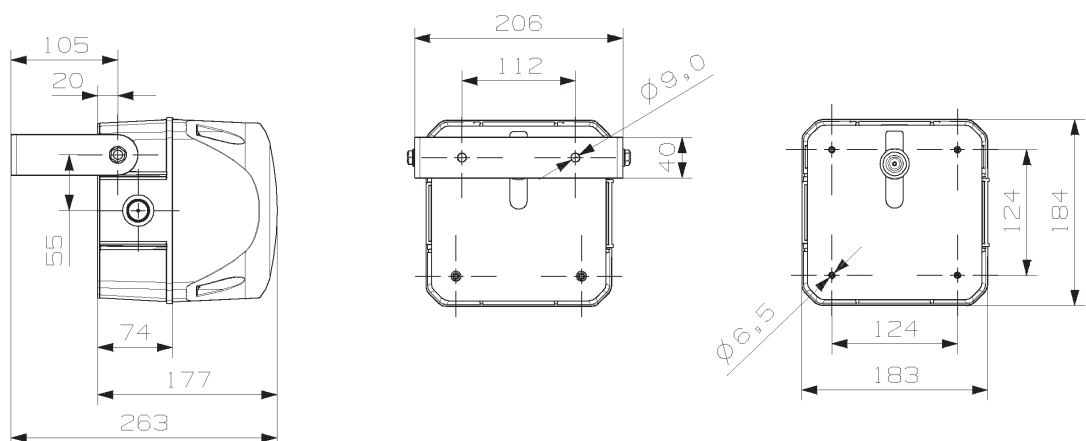

Beugel afzonderlijk te bestellen - zie pagina 40.  
Veuillez commander le support séparément - voir page 40.

- ▲ Optische en auditieve signalisatietoestellen
- ▲ Appareils de signalisation optiques et auditifs



Auer Signal

**QBX**

Multi strobe beacon

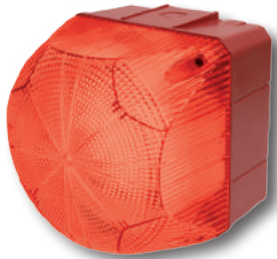

artikel article	spanning tension			stroom courant	temperatuur température	kleur couleur	
874861408	24-48 Vac/dc 16-60 Vdc, 16-53 Vac	400 Cd	IP66	max. 1,7 A	-30° +60° C		1
874862408	24-48 Vac/dc 16-60 Vdc, 16-53 Vac	400 Cd	IP66	max. 1,7 A	-30° +60° C		1
874864408	24-48 Vac/dc 16-60 Vdc, 16-53 Vac	400 Cd	IP66	max. 1,7 A	-30° +60° C		1
874865408	24-48 Vac/dc 16-60 Vdc, 16-53 Vac	400 Cd	IP66	max. 1,7 A	-30° +60° C		1
874866408	24-48 Vac/dc 16-60 Vdc, 16-53 Vac	400 Cd	IP66	max. 1,7 A	-30° +60° C		1
874867408	24-48 Vac/dc 16-60 Vdc, 16-53 Vac	400 Cd	IP66	max. 1,7 A	-30° +60° C		1
874861413	110-240 Vac/dc 80-265 Vac/dc	400 Cd	IP66	max. 0,4 A	-30° +60° C		1
874862413	110-240 Vac/dc 80-265 Vac/dc	400 Cd	IP66	max. 0,4 A	-30° +60° C		1
874864413	110-240 Vac/dc 80-265 Vac/dc	400 Cd	IP66	max. 0,4 A	-30° +60° C		1
874865413	110-240 Vac/dc 80-265 Vac/dc	400 Cd	IP66	max. 0,4 A	-30° +60° C		1
874866413	110-240 Vac/dc 80-265 Vac/dc	400 Cd	IP66	max. 0,4 A	-30° +60° C		1
874867413	110-240 Vac/dc 80-265 Vac/dc	400 Cd	IP66	max. 0,4 A	-30° +60° C		1

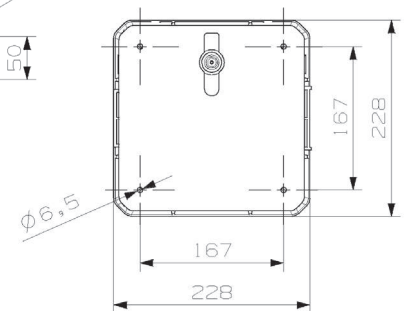
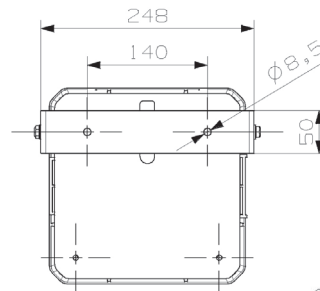
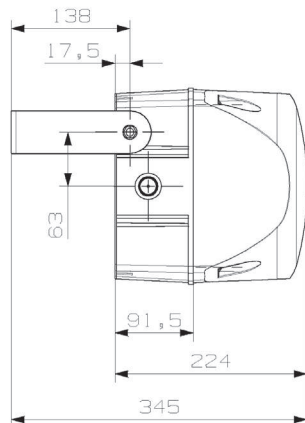

Beugel afzonderlijk te bestellen - zie pagina 40.  
Veuillez commander le support séparément - voir page 40.

▲ Optische en auditieve signalisatietoestellen  
▲ Appareils de signalisation optiques et auditifs



**Auer Signal**

**ACC**

Toebehoren voor Q-beacons  
Accessoires pour les balises Q



artikel article	omschrijving description	
874010900	mounting kit voor combinaties van Q-beacons kit de montage pour des combinaisons des balises Q	1
874031900	beugel - maat S support - taille S	1
874032900	beugel - maat M support - taille M	1
874033900	beugel - maat L support - taille L	1
874034900	beugel - maat XL support - taille XL	1

**KLH**

Elektromechanische mini-hoorn  
Mini trompe électromécanique



artikel article	spanning tension		stroom courant	Hz	dB		
710100105	24 Vac	± 10%	0,09 A	50	88	IP43	1
710100108	48 Vac	± 10%	0,06 A	50	88	IP43	1
710100110	110 Vac	± 10%	0,02 A	50	88	IP43	1
710100113	230 Vac	± 10%	0,011 A	50	88	IP43	1
710100004	12 Vdc	± 10%	0,055 A	-	92	IP43	1
710100005	24 Vdc	± 10%	0,026 A	-	92	IP43	1
710100010	110 Vdc	± 10%	0,016 A	-	92	IP43	1
710100013	220 Vdc	± 10%	0,011 A	-	92	IP43	1

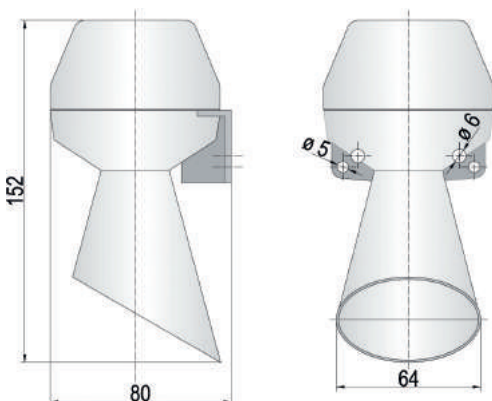

**Technische data / Données techniques**

temperatuur / température	-25° +50° C
toon / ton	continu

- ▲ Optische en auditieve signalisatietoestellen
- ▲ Appareils de signalisation optiques et auditifs



**Auer Signal**

**KDH**

Elektromechanisch signaaltoestel  
Avertisseur électromécanique



artikel article	spanning tension		stroom courant	Hz	dB		
710000105	24 Vac	± 10%	0,09 A	50	88	IP43	1
710000108	48 Vac	± 10%	0,06 A	50	88	IP43	1
710000110	110 Vac	± 10%	0,02 A	50	88	IP43	1
710000113	230 Vac	± 10%	0,011 A	50	88	IP43	1
710000004	12 Vdc	± 10%	0,055 A	-	92	IP43	1
710000005	24 Vdc	± 10%	0,026 A	-	92	IP43	1
710000010	110 Vdc	± 10%	0,016 A	-	92	IP43	1
710000013	220 Vdc	± 10%	0,011 A	-	92	IP43	1

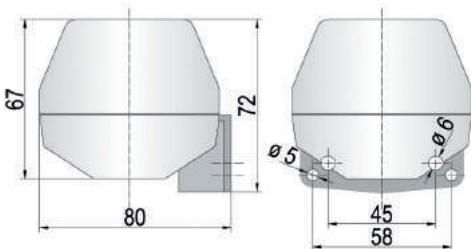

**Technische data / Données techniques**

temperatuur / température	-25° +50° C
toon / ton	continu

**HPT**

Elektromechanische hoorn  
Trompe électromécanique



artikel article	spanning tension		stroom courant	Hz	dB		
712100105	24 Vac	± 10%	1,2 A	50	108	IP55	1
712100108	48 Vac	± 10%	0,5 A	50	108	IP55	1
712100110	110 Vac	± 10%	0,23 A	50	108	IP55	1
712100113	230 Vac	± 10%	0,1 A	50	108	IP55	1
712100005	24 Vdc	± 10%	0,6 A	-	108	IP55	1
712100010	110 Vdc	± 10%	0,2 A	-	108	IP55	1
712100013	220 Vdc	± 10%	0,1 A	-	108	IP55	1

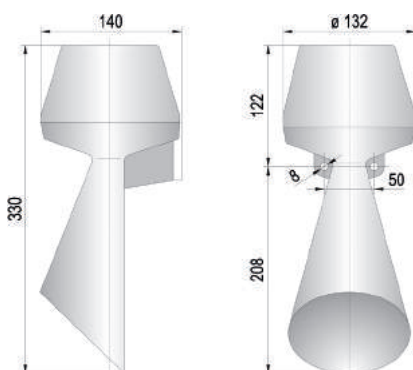

**Technische data / Données techniques**

temperatuur / température	-20° +50° C
toon / ton	continu

- ▲ Optische en auditieve signalisatietoestellen
- ▲ Appareils de signalisation optiques et auditifs



**Auer Signal**

**ESD** M28 panel mount buzzer, continuous



artikel article	spanning tension		stroom courant	aansluiting raccordement	dB		
810000405	24 Vac/dc	4-40 V	0,02 A	faston	90	IP30	1
810000313	230/240 Vac	30-250 V	0,02 A	faston	90	IP30	1

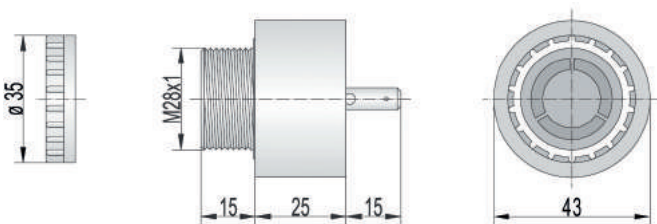

**ESP** M28 panel mount buzzer, pulsing



artikel article	spanning tension		stroom courant	aansluiting raccordement	dB		
811000405	24 Vac/dc	4-40 V	0,02 A	faston	90	IP30	1
811000313	230/240 Vac	30-250 V	0,02 A	faston	90	IP30	1

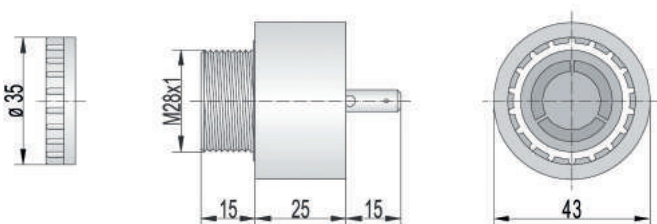

- ▲ Optische en auditieve signalisatietoestellen
- ▲ Appareils de signalisation optiques et auditifs



**Auer Signal**

**ESZ-S**

M28 panel mount buzzer, continuous & pulsing



artikel article	spanning tension		stroom courant	aansluiting raccordement	dB		
809000405	24 Vac/dc	6-28 V	0,02 A	faston	90	IP30	1
809000310	110/120 Vac	20-140 V	0,02 A	faston	90	IP30	1
809000313	230/240 Vac	50-250 V	0,02 A	faston	90	IP30	1

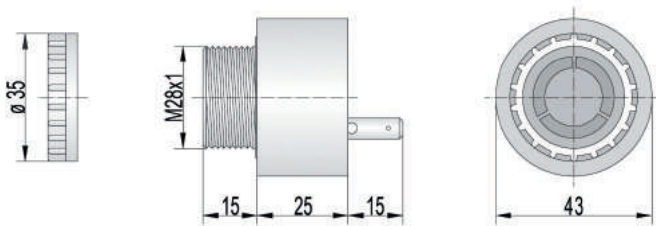

**ESZ-K**

M28 panel mount buzzer, continuous & pulsing



artikel article	spanning tension		stroom courant	aansluiting raccordement	dB		
809010405	24 Vac/dc	4-40 V	0,02 A	connector connecteur	90	IP30	1
809010310	110/120 Vac	20-140 V	0,02 A	connector connecteur	90	IP30	1
809010313	230/240 Vac	50-250 V	0,02 A	connector connecteur	90	IP30	1

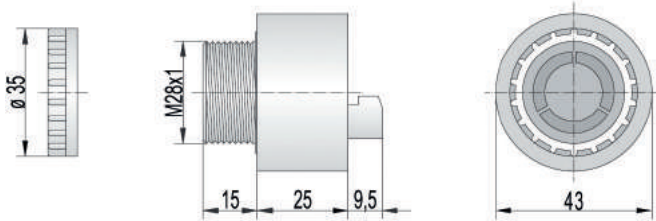



**Auer Signal**

**BEL**

Bel  
 Sonnette



artikel article	spanning tension	stroom courant	Hz	dB		
720400005	24 Vdc	0,4 A	-	106	IP66	1

artikel article	spanning tension	stroom courant	Hz	dB		
720300004	12 Vdc	0,7 A	-	106	IP66	1
720300005	24 Vdc	0,4 A	-	106	IP66	1
720300105	24 Vac	0,5 A	50/60	106	IP66	1
720300110	115 Vac	0,11 A	50/60	106	IP66	1
720300113	230 Vac	0,06 A	50/60	106	IP66	1

**Technische data / Données techniques**

temperatuur / température	-25° +50° C
tonen / tones'	TRIIING en/et TING TING TING
gewicht / poids	1,6 kg



- ▲ Optische en auditieve signalisatietoestellen
- ▲ Appareils de signalisation optiques et auditifs



**Auer Signal**

**HD90**

Lichttoren, steady light & buzzer (continuous & pulsing)

Colonne lumineuse, steady light & buzzer (continuous & pulsing)



artikel article	spanning tension	type	dB		
HD90-Q31	24 Vac/dc		90 dB	IP65	1
HD90-Q81	230 Vac				
HD90-Q32	24 Vac/dc		90 dB	IP65	1
HD90-Q82	230 Vac				
HD90-Q36	24 Vac/dc		90 dB	IP65	1
HD90-Q86	230 Vac				

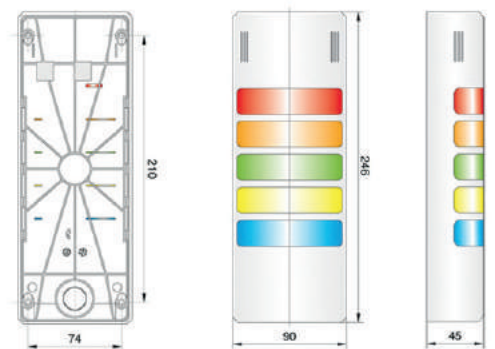
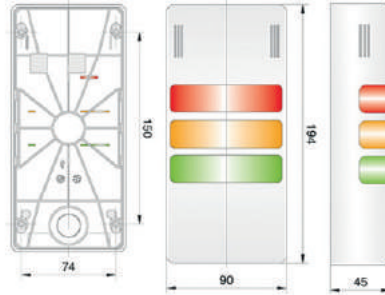
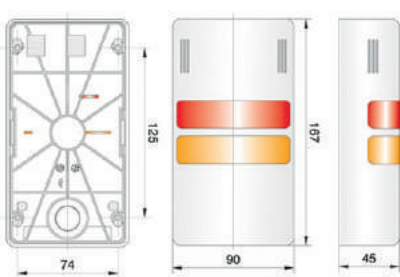

▲ Optische en auditieve signalisatietoestellen  
▲ Appareils de signalisation optiques et auditifs



**Auer Signal**

**C70**

Lichttoren, steady light & pre-wired (1 m)

Colonne lumineuse 70, steady light & pre-wired (1 m)



artikel article	spanning tension	kleur couleur	afmeting dimension		
C70-Q01	24 Vac/dc		Ø 69 x h 321 mm	IP65	1
C70-Q02	24 Vac/dc		Ø 69 x h 275 mm	IP65	1
C70-Q05	24 Vac/dc		Ø 69 x h 367 mm	IP65	1

**C70+**

Lichttoren, steady light & buzzer (continuous & pulsing), pre-wired (1 m)

Colonne lumineuse, steady light & buzzer (continuous & pulsing), pre-wired (1 m)



artikel article	spanning tension	kleur couleur	afmeting dimension		
C70-Q31	24 Vac/dc		Ø 69 x h 363 mm	IP65	1
C70-Q81	230 Vac		Ø 69 x h 363 mm	IP65	1

- ▲ Optische en auditieve signalisatietoestellen
- ▲ Appareils de signalisation optiques et auditifs



**Auer Signal**

**C30**

Lichttoren, steady light & pre-wired (1 m)  
 Colonne lumineuse, steady light & pre-wired (1 m)



artikel article	spanning tension	kleur couleur	afmeting dimension		
C30-Q01	24 Vac/dc		Ø 30 x h 321 mm	IP65	1
C30-Q02	24 Vac/dc		Ø 30 x h 275 mm	IP65	1
C30-Q05	24 Vac/dc		Ø 30 x h 367 mm	IP65	1

**C30**

Lichttoren, steady light & buzzer (continious & pulsing), pre-wired (1 m)  
 Colonne lumineuse, steady light & buzzer (continious & pulsing), pre-wired (1 m)



artikel article	spanning tension	kleur couleur	dB		
C30-Q31	24 Vac/dc		Ø 30 x h 363 mm	IP65	1
C30-Q81	230 Vac		Ø 30 x h 363 mm	IP65	1



Auer Signal

MDD

Ex-proof LED signal beacons



4 functies / fonctions:  
steady - flashing - strobe - rotating

artikel article	spanning tension	kleur couleur	temperatuur température		
336002413	230 Vac ± 20%	●	-40° +65° C	IP66	1
336004413	230 Vac ± 20%	○	-40° +65° C	IP66	1
336005413	230 Vac ± 20%	●	-40° +65° C	IP66	1
336006413	230 Vac ± 20%	●	-40° +65° C	IP66	1
336007413	230 Vac ± 20%	●	-40° +65° C	IP66	1
336002005	24 Vdc ± 20%	●	-40° +65° C	IP66	1
336004005	24 Vdc ± 20%	○	-40° +65° C	IP66	1
336005005	24 Vdc ± 20%	●	-40° +65° C	IP66	1
336006005	24 Vdc ± 20%	●	-40° +65° C	IP66	1
336007005	24 Vdc ± 20%	●	-40° +65° C	IP66	1



II 2 G Ex e mb (ib) IIC T4  
-40 ° C ≤ Ta ≤ +60 ° C (AC-Mod.)  
-40 ° C ≤ Ta ≤ +65 ° C (DC-Mod.)  
II 2 D Ex mbD tD  
A21 IP66 T130 ° C  
Zone 1, 21, 2, 22

- ▲ Optische en auditieve signalisatietoestellen
- ▲ Appareils de signalisation optiques et auditifs





**Auer Signal**

**MMD**

Ex-proof LED multi-colour signal beacons



artikel article	spanning tension	kleur couleur	temperatuur température		
337000313	230 Vac ± 20%	RGB	-20° +50° C	IP66	1
337000005	24 Vdc ± 20%	RGB	-20° +50° C	IP66	1



II 3 G Ex nR IIC T6  
II 3 D Ex tD A22 IP66 T85 ° C  
-20 ° C ≤ Ta ≤ +50 ° C  
Zone 2, 22

3 functies / fonctions:  
steady - flashing - strobe





Auer Signal

**ILL** Light bar zonder schakelaar  
 Light bar sans interrupteur



artikel article	spanning tension	stroom courant		
805100405	24/48 Vac/dc 17-73 Vdc, 17-54 Vac	0,53 A	IP44	1
805100413	110/240 Vac/dc 90-250 Vac/dc	0,13 A	IP44	1

**Technische data / Données techniques**

temperatuur / température	-35° +60° C
afmeting / dimension	419 x 65 x 31 mm



**ILL+** Light bar met aan-uit-schakelaar  
 Light bar avec interrupteur



artikel article	spanning tension	stroom courant		
805110405	24/48 Vac/dc 17-73 Vdc, 17-54 Vac	0,53 A	IP40	1
805110413	110/240 Vac/dc 90-250 Vac/dc	0,13 A	IP40	1

**Technische data / Données techniques**

temperatuur / température	-35° +60° C
afmeting / dimension	419 x 65 x 38 mm









**150/N**

Zwaailichten  
Feux rotatifs



artikel / article	150NO24		150NO220
	150NR24		150NR220
	150NG24		150NG220
	150NB24		150NB220
	150NGR24		150NGR220
spanning / tension	24 Vdc		230 Vac
vermogen puissance	45 W		40 W
stroom courant	1,88 A		0,18 A
lamptype / type de lampe	halogeen / halogène		
omwentelingen / rotations	110 / min.		
temperatuur / température	-20° +40° C		
materiaal / matériel	methacrylaat / méthacrylate		
beschermingsgraad motor indice de protection moteur	IP53		
gewicht / poids	850 gr		



▲ LED signalisatie  
▲ Signalisation LED



**SAFL**

Op batterijen/magnetisch  
Sur batteries/magnétique



artikel article	omschrijving description	kleur couleur	
SAFL01A	360° LED Flitslicht op batterij feu flash LED 360° à batterie		1

**Technische data / Données techniques**

magnetisch	magnétique
24 ultra bright LED's	24 LED's ultra claire
60 triple flitsen per minuut	60 triple flash par minute
2 mogelijke functies voor bediening: • door middel van aan-uit-schakelaar (drukknop) • door middel van geïntegreerde fotocel: licht begint automatisch te pinken wanneer het donker wordt en schakelt zich automatisch uit wanneer het licht wordt	2 fonctions possibles: • par bouton on/off (poussoir) • par moyen d'une cellule photométrique intégrée: le feu fonctionne quand il fait noir et s'éteint automatiquement au lever du soleil
werkt op 2 "D" batterijen (niet inbegrepen)	fonctionne sur 2 piles "D" (non comprise)
autonomie: tot 200 uur	autonomie: jusqu'à 200 heures



OFF





ON



**TOAD06**

Oplaadbaar/magnetisch  
Rechargeable/magnétique



artikel article	omschrijving description	kleur couleur	
TOAD06A	6 oplaadbare LED-modules 6 modules LED rechargeables		1
TOAD06B			1



**Technische data / Données techniques**

koffer is tevens laadstation (12/24 Vdc + 220 Vac)	valise avec chargeur intégré (12/24 Vdc + 220 Vac)
16 LED's per module	16 LED's dans 1 module
9 verschillende flitspatronen	9 différentes fonctions du flash
magnetisch	magnétique
waterdicht	étanche
stootvast	résistant aux chocs
Ø x h: 108 x 35 mm	Ø x h: 108 x 35 mm

**TOAD01**

Oplaadbaar/magnetisch  
Rechargeable/magnétique



artikel article	omschrijving description	kleur couleur	
TOAD01A	oplaadbare LED-module module LED rechargeable		1
TOAD01B			1

**Technische data / Données techniques**

inclusief lader (12/24 Vdc + 220 Vac)	chargeur inclus (12/24 Vdc + 220 Vac)
16 LED's per module	16 LED's dans 1 module
9 verschillende flitspatronen	9 différentes fonctions du flash
magnetisch	magnétique
waterdicht	étanche
stootvast	résistant aux chocs
Ø x h: 108 x 35 mm	Ø x h: 108 x 35 mm

▲ Markeerlichten  
▲ Feux de position



90A

Markeerlichten 12/24 Vdc  
Feux de position 12/24 Vdc



OFF

ON

artikel article	off	on	
90A00			1

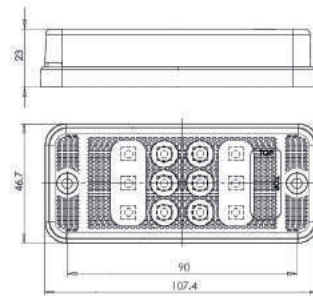

OFF

ON

artikel article	off	on	
90A11			1

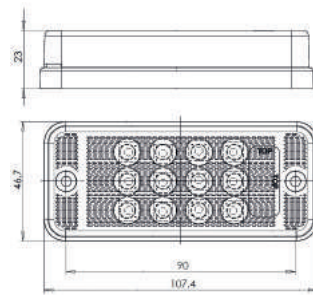

OFF

ON

artikel article	off	on	
90A01			1

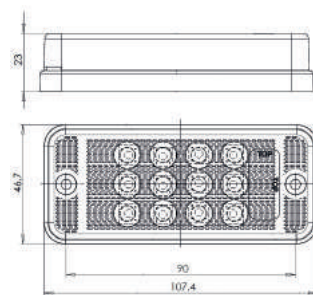





▲ Markeerlichten  
▲ Feux de position



**61A** Markeerlichten 12/24 Vdc  
Feux de position 12/24 Vdc





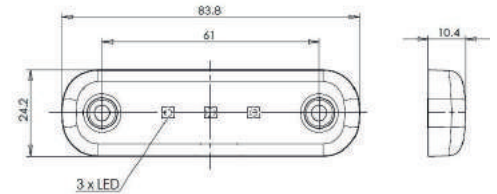

artikel article	kleur couleur	
61A00		1
61A22		1
61A11		1



**213A** Markeerlichten 12/24 Vdc  
Feux de position 12/24 Vdc



artikel article	kleur couleur	
213A00		1
213A22		1
213A11		1

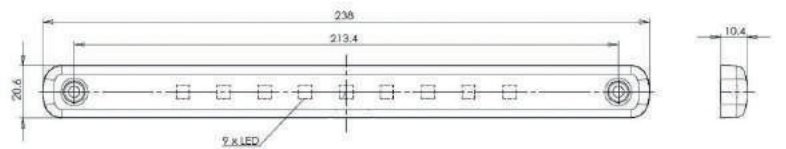

**61B** Binnenverlichting 12 of 24 Vdc  
Éclairage intérieur 12 ou 24 Vdc



artikel article	kleur couleur	spanning tension	
61B-12V		12V	1
61B-24V		24V	1

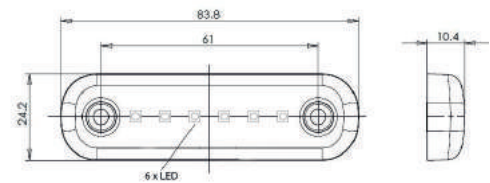

**213B** Binnenverlichting 12 of 24 Vdc  
Éclairage intérieur 12 ou 24 Vdc



213B



213BS



schakelaar  
interrupteur



213BB



bewegingssensor  
détecteur de mouvement

artikel article	kleur couleur	spanning tension	
213B-12V		12V	1
213B-24V		24V	1
213BS-12V		12V	1
213BS-24V		24V	1
213BB-12V		12V	1
213BB-24V		24V	1

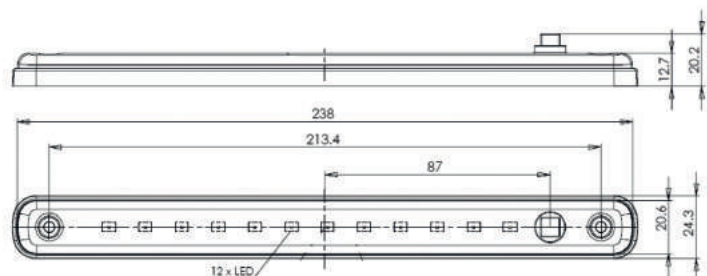

- ▲ Motorsirenes
- ▲ Sirènes à moteur



## MS1.45

Motorsirenes  
Sirènes à moteur



MS1.45A



MS1.45E



MS1.45V



artikel / article	MS1.45/*12V	MS1.45/*24V	MS1.45/*125V	MS1.45/*230V
spanning / tension	12 Vdc	24 Vac/dc	125Vac/dc	230 Vac/dc
geluidsvolume / volume sonore	114 dB(A) @ 1 m		112 dB(A) @ 1 m	
type	continu			
frequentie / fréquence	1300 Hz			
werking / fonctionnement	15 min.			
nominaal vermogen puissance nominale	45 W		70 W	
gemiddelde stroom courant moyen	3,75 A	1,85 A	0,56 A	0,32 A
temperatuur / température	-20° +40° C			
beschermingsgraad motor indice de protection moteur	IP44			
beschermingsgraad fan indice de protection ventilateur	IP14			
materiaal / matériel	aluminium/ABS			

\* Kies uw variant: A, E of V  
Choisissez votre variante: A, E ou V



▲ Motorsirenes  
▲ Sirènes à moteur



**MS2.114**

Motorsirenes  
Sirènes à moteur



MS2.114A

1,7 kg



MS2.114E

1,8 kg



MS2.114V

2 kg

artikel / article	MS2.114/ *12V	MS2.114/ *24V	MS2.114/ *125V	MS2.114/ *230V
spanning / tension	12 Vac/dc	24 Vac/dc	125Vac/dc	230 Vac/dc
geluidsvolume / volume sonore	116 dB(A) @ 1 m			
type	continu			
frequentie / fréquence	725 Hz			
werking / fonctionnement	15 min.			
nominaal vermogen puissance nominale	140 W		200 W	
gemiddelde stroom courant moyen	11,5 A	5,9 A	1,6 A	0,9 A
temperatuur / température	-20° +40° C			
beschermingsgraad motor indice de protection moteur	IP44			
beschermingsgraad fan indice de protection ventilateur	IP14			
materiaal / matériel	aluminium / ABS			

\* Kies uw variant: A, E of V  
Choisissez votre variante: A, E ou V



▲ Motorsirenes  
▲ Sirènes à moteur



**340/D(M)**

Motorsirenes

**400/D**

Sirènes à moteur

**450/D**

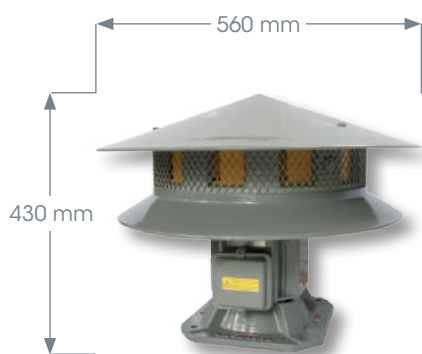

340/DM

340/D

23 kg

25 kg

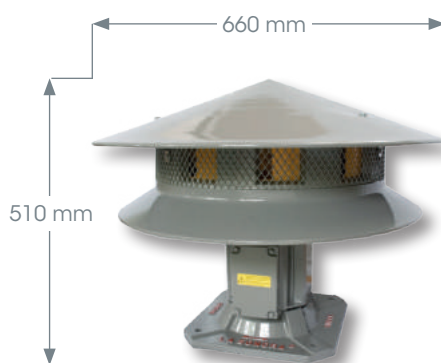

400/D

33 kg

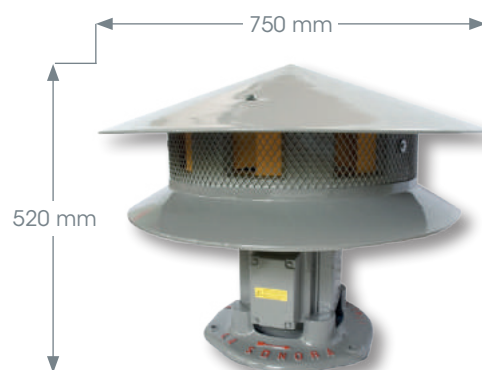

450/D

55 kg

artikel / article	340/DM	340/D	400/D	450/D
model / modèle	monofasig/monophasée		driefasig/triphasée	
geluidsvolume / volume sonore	123 dB(A) @ 1 m		128 dB(A) @ 1 m	131 dB(A) @ 1 m
reikwijdte / portée	tot/jusqu'à 1 km		tot/jusqu'à 1,8 km	tot/jusqu'à 2,5 km
type	continu			
frequentie / fréquence	522 Hz	515 Hz	475 Hz	430 Hz
acceleratietijd temps d'accélération	10 s	6 s	3 s	2 s
nominaal vermogen puissance nominale	1 kW (1,5 HP)	0,74 kW (1 HP)	2,2 kW (3 HP)	4 kW (5,5 HP)
gemiddeld verbruik bij 230 V consommation moyenne à 230 V	5,5 A	3,5 A	8 A	13 A
maximaal verbruik bij 230 V consommation maximum à 230 V	26 A	22 A	52 A	90 A
gemiddeld verbruik bij 400 V consommation moyenne à 400 V	-	2 A	4,5 A	8 A
maximaal verbruik bij 400 V consommation maximum à 400 V	-	13 A	30 A	52 A
temperatuur / température	-20° +40° C			
beschermingsgraad motor indice de protection moteur	IP55			
beschermingsgraad fan indice de protection ventilateur	IP25			
materiaal / matériel	aluminium			

**A100**

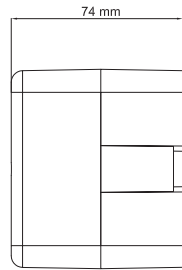
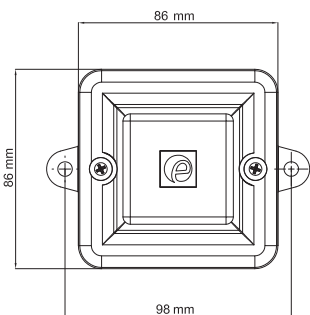

artikel article	spanning tension	stroom courant	
A100DC24R	10-30 Vdc	25 mA	1
A100AC230R	230 Vac ( $\pm 10\%$ ) 50/60 Hz	15 mA	1

**Technische data / Données techniques**

max. geluidsvolume volume sonore max.	<b>104 dB @ 1 m</b>
aantal tonen / nombre de sons	32
niveaus / niveaux	3
temperatuur / température	-25° +55° C
reikwijdte / portée	32 m
beschermingsgraad / indice de protection	IP66
norm / norme	EN54-3

**A105N**

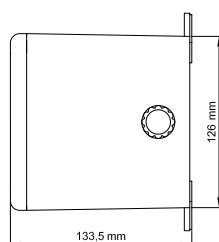
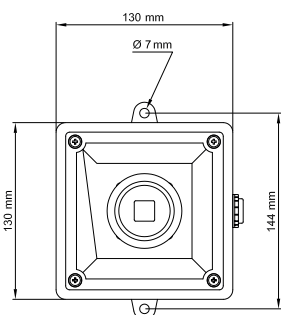

artikel article	spanning tension	stroom courant	
A105NDC24R	10-30 Vdc	25 mA	1
A105NAC230R	230 Vac ( $\pm 10\%$ ) 50/60 Hz	15 mA	1

**Technische data / Données techniques**

max. geluidsvolume volume sonore max.	<b>112 dB @ 1 m</b>
aantal tonen / nombre de sons	32
niveaus / niveaux	3
temperatuur / température	-25° +55° C
reikwijdte / portée	60 m
beschermingsgraad / indice de protection	IP66
norm / norme	EN54-3

- ▲ Elektronische signalisatietoestellen
- ▲ Appareils électroniques de signalisation



## A112N

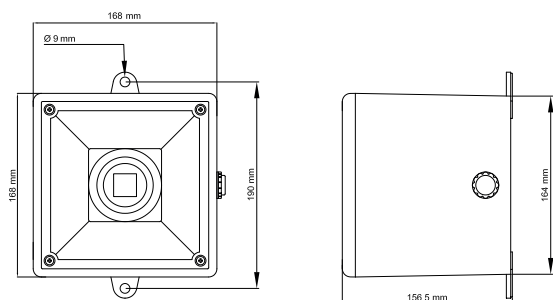

artikel article	spanning tension	stroom courant	
A112NDC24R	10-30 Vdc	200 mA	1
A112NAC230R	230 Vac ( $\pm 10\%$ ) 50/60 Hz	60 mA	1

### Technische data / Données techniques

max. geluidsvolume volume sonore max.	119 dB @ 1 m
aantal tonen / nombre de sons	45
niveaus / niveaux	3
temperatuur / température	-25° +55° C
reikwijdte / portée	125 m
beschermingsgraad / indice de protection	IP66
norm / norme	EN54-3

## A121

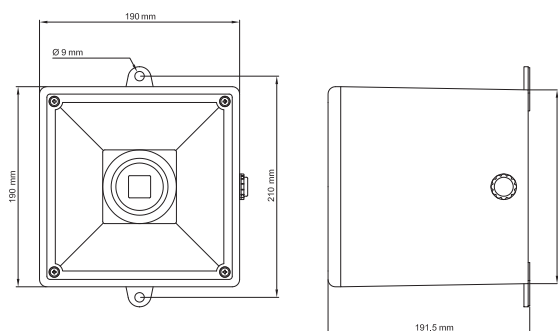

artikel article	spanning tension	stroom courant	
A121DC24R	10-30 Vdc	950 mA	1
A121AC230R	230 Vac ( $\pm 10\%$ ) 50/60 Hz	120 mA	1

### Technische data / Données techniques

max. geluidsvolume volume sonore max.	126 dB @ 1 m
aantal tonen / nombre de sons	45
niveaus / niveaux	3
temperatuur / température	-25° +55° C
reikwijdte / portée	300 m
beschermingsgraad / indice de protection	IP66
norm / norme	EN54-3

**A105NAX**

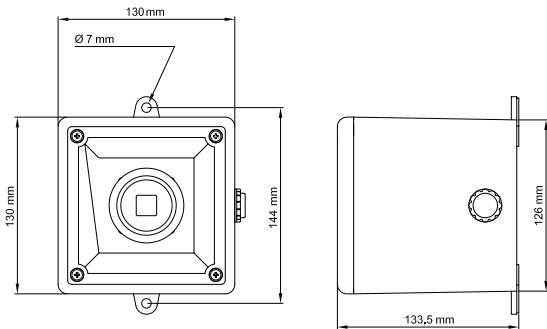

artikel article	spanning tension	stroom courant	
A105NAXDC24R-UL	10-30 Vdc	25 mA	1
A105NAXAC230R-UL	90-260 Vac	124 mA	1

**Technische data / Données techniques**

max. geluidsvolume / volume sonore max.	<b>110 dB @ 1 m</b>
max. volume stem / volume voix max.	<b>102 dB @ 1m</b>
aantal tonen / nombre de sons	45
boodschappen / messages	4 x 30 s
temperatuur / température	-25° +55° C
reikwijdte / portée	60 m
beschermingsgraad / indice de protection	IP66
afmeting / dimension	130 x 130 x 133,5 mm (dc) 130 x 130 x 188 mm (ac)
opmerking / remarque	volumeregeling contrôle de volume

**A121AX**

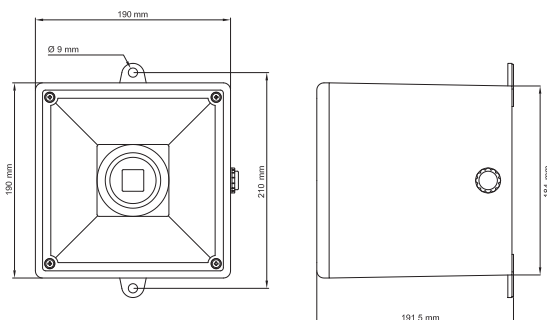

artikel article	spanning tension	stroom courant	
A121AXDC24R-UL	14-30 Vdc	1,51 A	1
A121AXAC230R-UL	90-260 Vac	517 mA	1

**Technische data / Données techniques**

max. geluidsvolume / volume sonore max.	<b>126 dB @ 1 m</b>
max. volume stem / volume voix max.	<b>111 dB</b>
aantal tonen / nombre de sons	45
boodschappen / messages	4 x 30 s
temperatuur / température	-25° +55° C
reikwijdte / portée	300 m
beschermingsgraad / indice de protection	IP66
afmeting / dimension	190 x 190 x 210 mm
opmerking / remarque	volumeregeling contrôle de volume

- ▲ Elektronische signalisatietoestellen
- ▲ Appareils électroniques de signalisation



## MA112

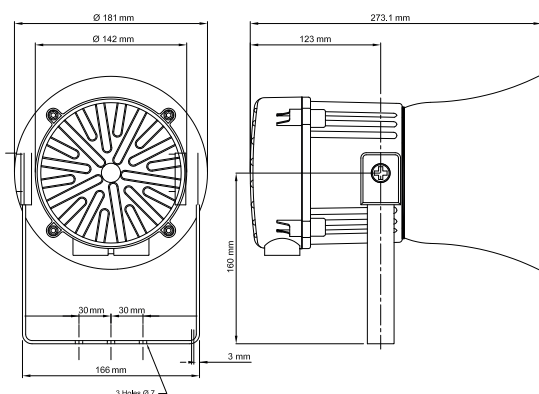



artikel article	spanning tension	stroom courant	
MA112FDC024BN1A1G	10-30 Vdc	200 mA	1
MA112FAC230BN1A1G	230 Vac ( $\pm 10\%$ ) 50/60 Hz	60 mA	1

### Technische data / Données techniques

max. geluidsvolume volume sonore max.	<b>119 dB @ 1 m</b>
aantal tonen / nombre de sons	45
niveaus / niveaux	3
temperatuur / température	-25° +55° C
reikwijdte / portée	300 m
beschermingsgraad / indice de protection	IP66/67
afmeting / dimension	181 x 181 x 273 mm

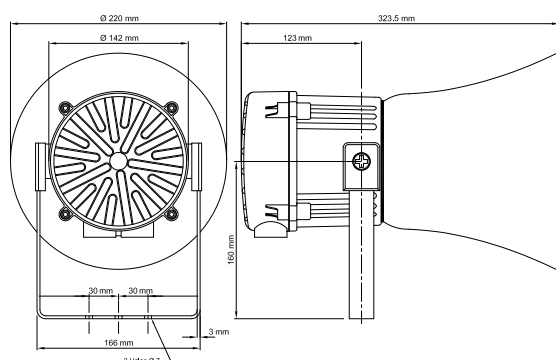
## MA121



artikel article	spanning tension	stroom courant	
MA121FDC024BN1A1G	10-30 Vdc	950 mA	1
MA121FAC230BN1A1G	230 Vac ( $\pm 10\%$ ) 50/60 Hz	120 mA	1

### Technische data / Données techniques

max. geluidsvolume volume sonore max.	<b>126 dB @ 1 m</b>
aantal tonen / nombre de sons	45
niveaus / niveaux	3
temperatuur / température	-25° +55° C
reikwijdte / portée	300 m
beschermingsgraad / indice de protection	IP66/67
afmeting / dimension	220 x 220 x 323,5 mm

**A131**

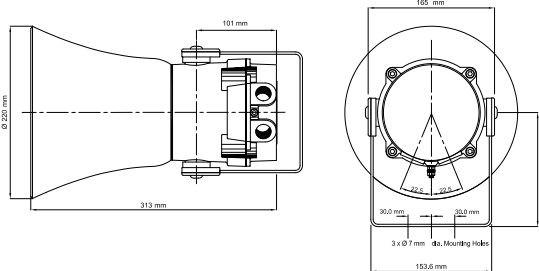

artikel article	spanning tension	stroom courant	
A131DC24G1	18-30 Vdc	3,2A	1
A131AC230G1	90-264 Vac	390 mA	1

**Technische data / Données techniques**

max. geluidsvolume volume sonore max.	<b>131 dB @ 1 m</b>
aantal tonen / nombre de sons	45
niveaus / niveaux	3
temperatuur / température	-20° +55° C
reikwijdte / portée	300 m
beschermingsgraad / indice de protection	IP65/66
afmeting / dimension	220 x 220 x 313 mm
afmeting / dimension (control box)	219 x 139,8 x 108 mm

**A141**

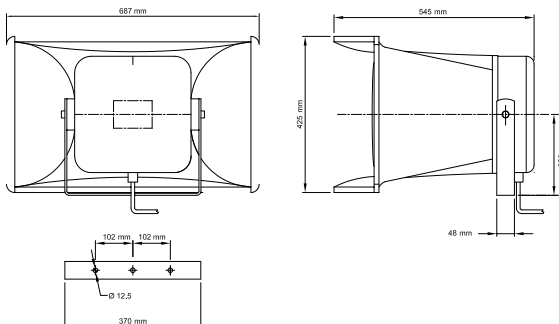

artikel article	spanning tension	stroom courant	
A141DC24G	18-30 Vdc	13,2 A	1
A141AC230G	90-264 Vac	1,95 A	1

**Technische data / Données techniques**

max. geluidsvolume volume sonore max.	<b>141 dB @ 1 m</b>
aantal tonen / nombre de sons	45
niveaus / niveaux	3
temperatuur / température	-20° +55° C
reikwijdte / portée	400-700m
beschermingsgraad / indice de protection	IP65
afmeting / dimension	687 x 425 x 545 mm
afmeting / dimension (control box)	219 x 139,8 x 108 mm

- ▲ Elektronische signalisatietoestellen
- ▲ Appareils électroniques de signalisation



### H100T

Elektronische hoorn  
Trompe électronique

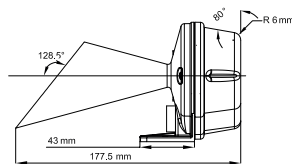
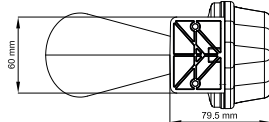
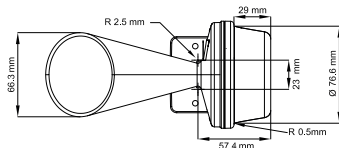
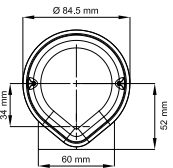
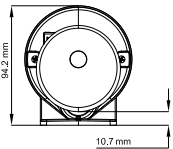

artikel article	spanning tension	stroom courant	
H100T030G	12-30 Vdc/ac	24 mA	1
H100T230G	40-260 Vdc/ac	10 mA	1

#### Technische data / Données techniques

max. geluidsvolume volume sonore max.	100 dB @ 1m
aantal tonen / nombre de sons	3
niveaus / niveaux	1
temperatuur / température	-25° + 50° C
beschermingsgraad / indice de protection	IP65
opmerking / remarque	volumeregeling contrôle de volume

### H110T

Elektronische hoorn  
Trompe électronique

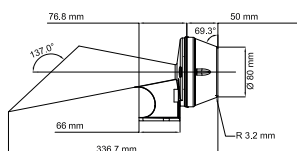
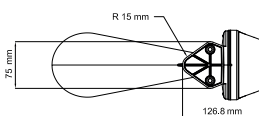
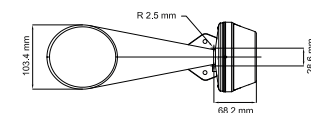
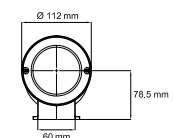
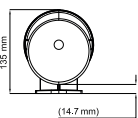

artikel article	spanning tension	stroom courant	
H110T030G	10-30 Vdc/ac	105 mA	1
H110T230G	40-260 Vdc/ac	18 mA	1

#### Technische data / Données techniques

max. geluidsvolume volume sonore max.	110 dB @ 1m
aantal tonen / nombre de sons	3
niveaus / niveaux	1
temperatuur / température	-25° + 50° C
beschermingsgraad / indice de protection	IP65
opmerking / remarque	volumeregeling contrôle de volume



- ▲ Sirenes voor grote gebieden
- ▲ Sirènes pour des grandes zones

### Comtel

- ▲ Waarschuwingssystemen op maat.
- ▲ Systèmes d'avertissement adaptés à vos besoins

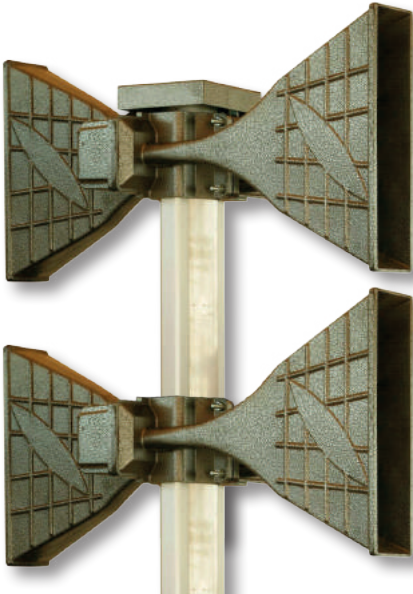

# ALAA

4K helpt u graag bij het realiseren van uw projecten om mensen in gevaar te waarschuwen. **Bel ons!**

4K se fera un plaisir de vous aider à réaliser vos projets pour avertir les gens en danger. **Appelez-nous!**

Een systeem met 12 luidsprekerhoorns op een site in de haven  
Un système de 12 haut-parleurs sur un site dans le port



Comtel Smart Phone Application is een makkelijk te gebruiken applicatie voor Android en iOS voor de aansturing van deze elektronische sirenes. Het kan gebruikt worden door bevoegd personeel van militaire basissen, luchthavens, kerncentrales, de politie, de civiele bescherming, havens, industriële sites enzovoort.

Comtel Smart Phone Application est une application facile à utiliser pour Android et iOS pour contrôler ces sirènes électroniques. Elle peut être utilisée par le personnel autorisé des bases militaires, des aéroports, des centrales nucléaires, la police, la défense civile, les ports, les sites industriels et ainsi de suite.

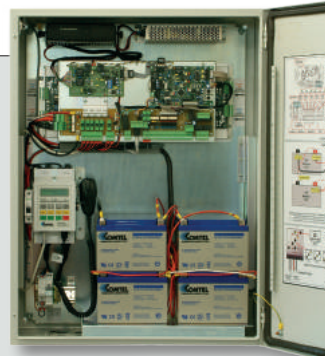

De CMC-4 is een multifunctionele HMI-console voor het bedienen van Comtel's sirenes. De CMC-4 kan individuele sirenes of een groep van sirenes controleren.

Le CMC-4 est une console HMI multi-fonctionnelle pour faire fonctionner les sirènes de Comtel. Le CMC peut contrôler sirènes individuelles ou un groupe de sirènes.

De elektronische sirenes worden geproduceerd in verschillende modellen met aangepast aantal versterkers, luidsprekers hoorns en het type richting (omnidirectioneel of gericht).

Les sirènes électroniques sont produites dans différents modèles avec un nombre ajusté d'amplificateurs, des haut-parleurs et le type de direction (omni ou directionnelle).

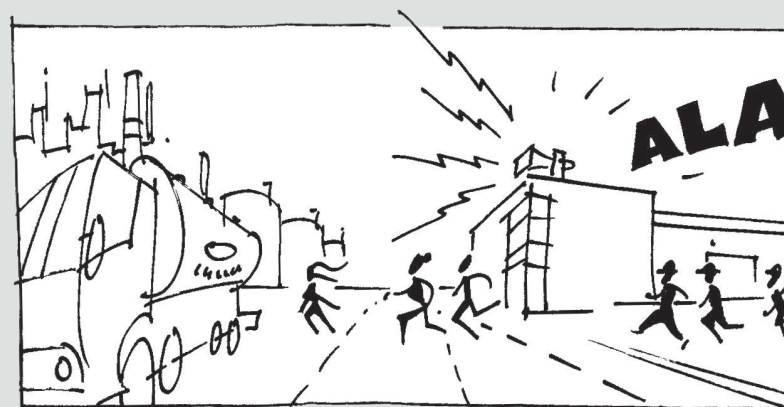

# WARRMMM!!!



3

Het kan afstanden van 200 tot 2500 meter dekken met een akoestisch vermogen van 106 tot 127 dB op 30 meter.

La portée est de 200 à 2500 mètres avec une puissance acoustique de 106 jusqu'à 127 dB à 30 mètres.



Onze ervaren specialisten staan tot uw beschikking  
Nos spécialistes expérimentés sont à votre disposition

COMTEL exporteert sinds 2004 met aanzienlijk succes binnen en buiten Europa  
COMTEL vent depuis 2004 avec un succès considérable en Europe et au-delà



▲ Professionele LED zak- en hoofdlampen  
▲ Lampes LED de poche et frontales professionnelles



**Q1**

LED-zaklampen  
Lampes LED de poche

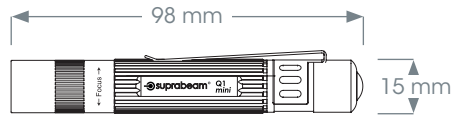

artikel article	omschrijving description						
501.2009	Q1mini, de ultieme miniatuurzaklamp Q1mini, la lampe de poche miniature ultime	80 Lm	60 m	1 x AAA 1 h - 5 h	5° - 65°	38 g	1



artikel article	omschrijving description						
501.3009	Q1, de ultieme pen-zaklamp voor professionals Q1, torche stylo ultime pour les professionnels	100 Lm	70 m	2 x AAA 3 h - 10 h	5° - 65°	56 g	1

**Q2**

LED-zaklamp  
Lampe LED de poche

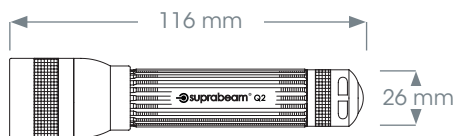

artikel article	omschrijving description						
502.1009	Q2, lichtgewicht met focussysteem van de Q3- en Q7-modellen met tasje Q2, poids plume avec système focale des modèles Q3 et Q7 avec pochette	170 Lm	150 m	1 x AA 2 h - 5 h	5° - 60°	80 g	1

- ▲ Professionele LED zak- en hoofdlampen
- ▲ Lampes LED de poche et frontales professionnelles



**Q3**

LED-zaklampen  
Lampes LED de poche

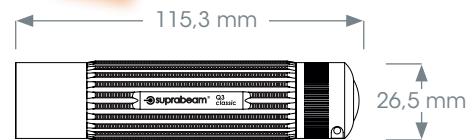

artikel article	omschrijving description						
503.1509	Q3classic, kwaliteitsvolle zaklamp met vaste stralingshoek met tasje Q3classic, torche de qualité avec faisceau fixe avec pochette	280 Lm	210 m	3 x AAA 1h - 20 h	5°	96 g	1

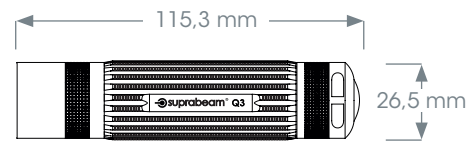

artikel article	omschrijving description						
503.1009	Q3, compact en uitermate krachtig met tasje Q3, compacte et extrêmement puissante avec pochette	320 Lm	230 m	3 x AAA 1 h 30 - 60 h	5° - 60°	99 g	1



artikel article	omschrijving description						
503.5109	Q3r, oplaadbaar vermogen met reservebatterij en tasje Q3r, alimentation rechargeable avec batterie de réserve et pochette	400 Lm	245 m	Li-ion 1 h 45 - 89 h	5° - 60°	139 g	1





▲ Professionele LED zak- en hoofdlampen  
 ▲ Lampes LED de poche et frontales professionnelles



Q4

LED-zaklamp

Lampe LED de poche

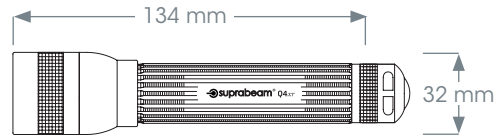

artikel article	omschrijving description						
504.6109	Q4xr, erg krachtige oplaadbare zaklamp met reservebatterij en tasje Q4xr, torche puissante rechargeable avec batterie de réserve et pochette	800 Lm	250 m	Li-ion 2 h - 24 h	5° - 60°	132 g	1



Q7

LED-zaklamp

Lampe LED de poche

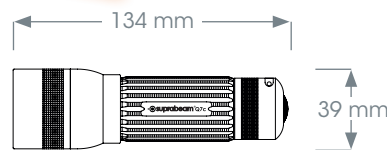

artikel article	omschrijving description						
507.2509	Q7compact, combineert topprestaties en standaard batterijen, met tasje Q7compact, combine des performances et batteries standard avec pochette	350 Lm	220 m	4 x AAA 1 h - 75 h	5° - 70°	196 g	1

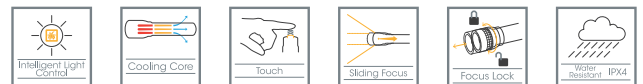

Because you can never have enough

**LIGHT**



▲ Professionele LED zak- en hoofdlampen  
 ▲ Lampes LED de poche et frontales professionnelles



**Q7**

LED-zaklamp  
 Lampe LED de poche

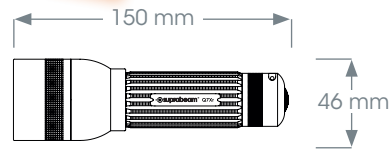

artikel article	omschrijving description						
507.6109	Q7xr, topmodel met zeer hoge lichtopbrengst met reservebatterij en tasje Q7xr, modèle haut de gamme avec source lumineuse élevée avec deuxième batterie et pochette	1000 Lm	345 m	Li-ion 2 h 45 - 37 h	5° - 70°	307 g	1



**DEFEND**

LED-zaklampen  
 Lampes LED de poche

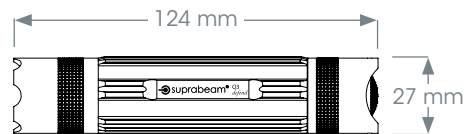

artikel article	omschrijving description						
503.4009	Q3defend, compact - krachtig tactische LED zaklamp met tasje Q3defend, torche LED tactique avec pochette, compacte - puissante	280 Lm	210 m	3 x AAA 1 h - 20 h	5° fixed	99 g	1

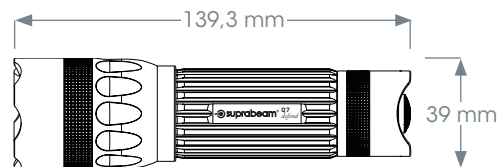

artikel article	omschrijving description						
507.4009	Q7defend, de ultieme tactische LED zaklamp met tasje Q7defend, torche LED tactique ultime avec pochette	350 Lm	220 m	4 x AAA 1 h - 75 h	5° - 70°	212 g	1









- ▲ Professionele LED zak- en hoofdlampen
- ▲ Lampes LED de poche et frontales professionnelles

 suprabeam®





**V3AIR**

LED-hoofdlampen  
Lampes LED frontales



artikel article	omschrijving description						
610.1009	V3air, lichtgewicht hoofdlamp voor maximum comfort V3air, lampe frontale légère pour un confort maximal	250 Lm	195 m	3 x AAA 1 h 15 - 100 h	6° - 60°	140 g	1



artikel article	omschrijving description						
610.5009	V3air rechargeable, lichtgewicht hoofdlamp voor maximum comfort V3air rechargeable, lampe frontale légère pour un confort maximal	320 Lm	210 m	Li-po 1 h 30 - 100 h	6° - 60°	148 g	1

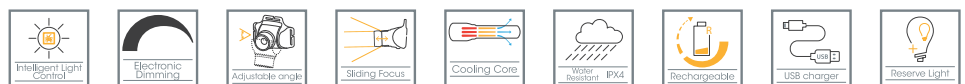



- ▲ Professionele LED zak- en hoofdlampen
- ▲ Lampes LED de poche et frontales professionnelles



**suprabeam®**

**V3PRO**

LED-hoofdlampen  
Lampes LED frontales



artikel article	omschrijving description						
612.1009	V3pro, krachtige professionele hoofdlamp met tasje V3Pro, lampe frontale puissante professionnelle avec pochette	380 Lm	210 m	3 x AA 6 h - 100 h	6° - 60°	204 g	1



artikel article	omschrijving description						
612.5009	V3pro rechargeable, krachtige oplaadbare hoofdlamp voor frequent gebruik met tasje V3Pro rechargeable, lampe frontale puissante pour une utilisation intensive avec pochette	500 Lm	245 m	Li-po 2 h - 100 h	6° - 60°	184 g	1



- ▲ Professionele LED zak- en hoofdlampen
- ▲ Lampes LED de poche et frontales professionnelles

 suprabeam®

**V4PRO**

LED-hoofdlamp  
Lampe LED frontale



V4pro rechargeable

artikel article	omschrijving description						
613.5009	V4pro rechargeable, Suprabeam's meest geavanceerde hoofdlamp met tasje V4pro rechargeable, lampe frontale la plus avancée de Suprabeam avec pochette	800 Lm	250 m	Li-po 1 h 45 - 100 h	10° - 30° mixed	195 g	1



- ▲ Professionele LED zak- en hoofdlampen
- ▲ Lampes LED de poche et frontales professionnelles



 **suprabeam**<sup>®</sup>

**ACC** Accessoire



artikel article	omschrijving description	
950.007	Siliconen helmband Bande élastique en silicone	1

**BAT** Batterijen  
Batteries



artikel article	type	specificaties spécifications	voor pour	
951.010	Li-ion 18650	2200 mA - 8,14 Wh	Q3r & Q4xr	1
951.012	Li-ion 26650	3800 mA - 14,06 Wh	Q7xr	1
951.013	Li-po 154250	2800 mA - 10,36 Wh	V3pro rechargeable & V4pro rechargeable	1
951.014	Li-po 113645	1400 mA - 10,36 Wh	V3air rechargeable	1

- ▲ Oplaadbare explosieveilige handlampen
- ▲ Eclairage à main antidéflagrant rechargeable



B69



Technische data / Données techniques		
Type	L3000	L3000 Power
artikel article	B69-7300-A	B69-7350-A
hoofdlamptype ampoule	2x high intensity LED 135 Lm	3x high intensity LED 135 Lm
weergave werkduur avis d'autonomie	in uren en minuten/en heures et minutes	
	10000 Cd - 200 Lm	15000 Cd - 300 Lm
	IP67	
	200 m	245 m
	Li-Ion 3,7 V - 4 - 8 h	
	12/24 Vdc/100-240 Vac	
	500 g	
L x Ø	225 x 70 mm	
	ATEX Certificate LOM 12ATEX2087 X II 1G Ex ia IIC T4 Ga IP67 / II 1D Ex ia IIIC T85° C Da	
weergave lage batterijspanning avis du niveau de batterie basse	✓	
draaibare kop tête pivotante	0° - 45° - 90°	

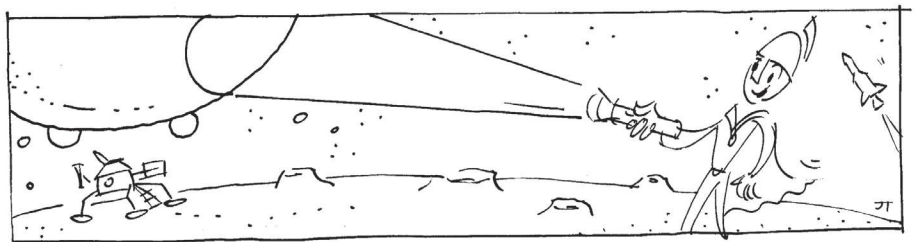

- ▲ Oplaadbare explosieveilige handlampen
- ▲ Eclairage à main antidéflagrant rechargeable



**B69**



artikel article	omschrijving description	
B69-7013-A	12/24 V lader 1 toestel 12/24 V chargeur 1 torche	1
B69-7011-A	220/240 V lader 1 toestel 220/240 V chargeur 1 torche	1



artikel article	omschrijving description	
B69-7040-A	12/24 V lader 3 toestellen 12/24 V chargeur 3 torches	1
B69-7020-A	220/240 V lader 3 toestellen 220/240 V chargeur 3 torches	1



artikel article	omschrijving description	
B69-7041-A	12/24 V lader 5 toestellen 12/24 V chargeur 5 torches	1
B69-7022-A	220/240 V lader 5 toestellen 220/240 V chargeur 5 torches	1



artikel article	omschrijving description	
B69-7328-A	Li-ion batterij met dichting Li-ion accu avec joint	1



artikel article	omschrijving description	
B69-7323-A	Signaalkegel rood Cône de signalisation rouge	1



artikel article	omschrijving description	
B69-7324-A	Signaalkegel geel Cône de signalisation jaune	1

- ▲ Oplaadbare zaklampen en werkluchten, noodlichtfunctie en Ex
- ▲ Torches rechargeables et éclairage de chantier, de secours et Ex

**2000** Oplaadbare zaklamp  
Torche rechargeable



loep / lentille

artikel article		kleur couleur			
405272	30000 mcd		dichtbij proximité	63 g	1
405282	30000 mcd		dichtbij proximité	63 g	1
405851		loep / lentille			1

NIMH 4,8 V/150 mAh  
± 210 min

120/230 Vac 50/60 Hz

**JOKER** Oplaadbare zaklamp  
Torche rechargeable



artikel article		kleur couleur			
408212	30000 mcd		dichtbij proximité	36 g	1
408232	30000 mcd		dichtbij proximité	36 g	1
408282	30000 mcd		dichtbij proximité	36 g	1

NIMH 4,8 V/20 mAh  
± 60 min

120/230 Vac 50/60 Hz

- ▲ Oplaadbare zaklampen en werklichten, noodlichtfunctie en Ex
- ▲ Torches rechargeables et éclairage de chantier, de secours et Ex



**MULTI** Oplaadbare zaklamp  
Torche rechargeable



artikel article		kleur couleur			
413262	4x 30000 mcd		± 50 m	152 g	1
413282	4x 30000 mcd		± 50 m	152 g	1

NIMH 4,8 V/20 mAh  
± 12 h

120/230 Vac 50/60 Hz

**NOVOPOWER** Oplaadbare zaklamp IP 54  
Torche rechargeable IP 54



artikel article		kleur couleur			
425082	114 Lm		± 100 m	145 g	1

NIMH 4,8 V/20 mAh  
± 90 min

120/230 Vac 50/60 Hz

**UNILUXPRO** Oplaadbare handschijnwerper  
Projecteur à main rechargeable



artikel article		kleur couleur			
442081	270 Lm		± 1000 m	400 g	1

Lithium-ion batterij 3,7 V/4,4 Ah  
± 6 h - 35 h

12/24 Vdc / 230 Vac 50/60 Hz



- ▲ Oplaadbare zaklampen en werklampen, noodlichtfunctie en Ex
- ▲ Torches rechargeables et éclairage de chantier, de secours et Ex

## JOBLUXPOWER

Werklicht met noodlichtfunctie

Eclairage de chantier avec fonction d'éclairage de secours



artikel article					
452441 flood	140 Lm	IP 44	± 140 m	2600 g	1
452541 spot	180 Lm	IP 44	± 160 m	2600 g	1

Onderhoudsvrije loodgel batterij 6V/7 Ah  
Batterie gel plomb sans entretien 6V/7 Ah  
± 11 h

12/24 Vdc - 230 Vac 50/60 Hz

## HALOLUX90A

Werklicht (10 W halogeen) met noodlichtfunctie

Eclairage de chantier (halogène 10 W) avec fonction d'éclairage de secours



artikel article					
454041	200 Lm	IP 44	± 100 m	2600 g	1

Onderhoudsvrije loodgel batterij 6V/7 Ah  
Batterie gel plomb sans entretien 6V/7 Ah  
± 3 h

12/24 Vdc - 230 Vac 50/60 Hz

## SL5/SL6

Werklicht met noodlichtfunctie

Eclairage de chantier avec fonction d'éclairage de secours



artikel article	type					
456441 flood	SL 5	170 Lm	IP 54	± 150 m	1100 g	1
456541 spot	SL 6	170 Lm	IP 54	± 170 m	1100 g	1

Onderhoudsvrije loodgel batterij 4V/3,5 Ah  
Batterie gel plomb sans entretien 4V/3,5 Ah  
± 5 h

12/24 Vdc - 230 Vac 50/60 Hz

- ▲ Oplaadbare zaklampen en werklichten, noodlichtfunctie en Ex
- ▲ Torches rechargeables et éclairage de chantier, de secours et Ex



**4EX** Explosieveilige en oplaadbare zaklamp  
Torche rechargeable et certifiée EX



artikel article					
417222	4x 30000 mcd	IP 65	± 50 m	150 g	1

**Ex** II 2 G Ex ib II C T4/II 2D Ex ibD 21 T 135° C

NIMH 4,8 V/550 mAh  
± 12 h  
 120/230 Vac 50/60 Hz

**HL10EX** Explosieveilige zaklamp  
Torche certifiée EX



artikel article					
492022	200 Lm	IP 67	± 150 m	167 g	1

**Ex** II 2 G Ex ib II C T4/II 2D Ex ibD 21 T 135° C

incl. 4x LR6, AA  
± 11 h

**MHL5EX** Explosieveilige zaklamp  
Torche certifiée EX



artikel article					
493022	42 Lm	IP 68	± 30 m	45 g	1

**Ex** II 2 G Ex ib II C T4 Gb/II 2D Ex ibD 21 T 135° C Db

incl. 2x LR03, AAA  
± 4 h

- ▲ Werklichten voor zwaar rollend materieel
- ▲ Projecteurs de travail pour poids lourds

**NORDICLIGHTS** 

**N4402**

Werklichten  
Projecteurs de travail

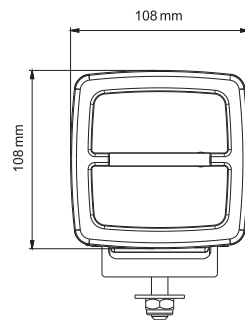
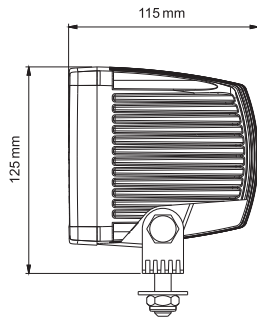

Wide Flood

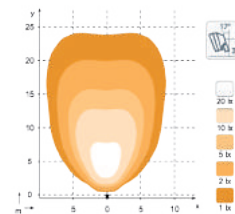

Flood

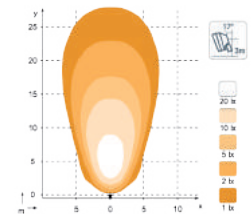

Low Beam

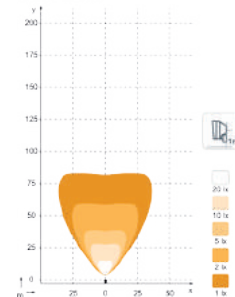

High Beam

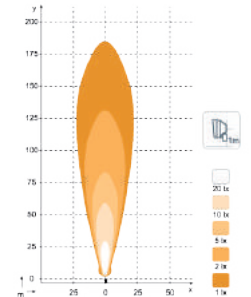

artikel / article	984-145	984-151	984-152	984-153
lichtpatroon / courbe photométrique	wide flood	flood	low beam	high beam
lichtstroom / flux lumineux	4200 Lm			
kleurtemperatuur température de couleur	5700 K			
spanning / tension	9-32 Vdc			
vermogen / puissance	50 W			
stroom bij 24 V / courant à 24 V	2,1 A			
connector / connecteur	Deutsch (2 pinnen/broches)			
montage	1 bout / boulon M10			
schokbestendigheid résistance aux chocs	60 G			
lens / lentille	transparant polycarbonaat / polycarbonate transparente			
behuizing / corps	aluminium			
gewicht / poids	1100 g			
beschermingsgraad / indice de protection	IP68			
temperatuur / température	-40° +85° C			
	1			

- ▲ Werklichten voor zwaar rollend materieel
- ▲ Projecteurs de travail pour poids lourds



**NORDICLIGHTS** 

**N26**

Werklichten

Projecteurs de travail

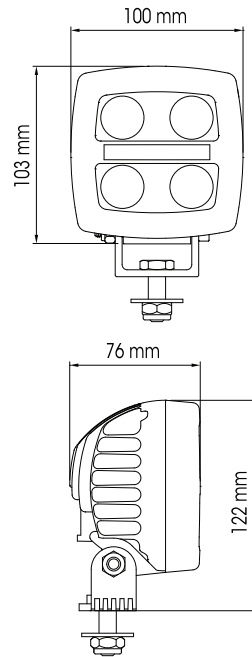

Wide Flood

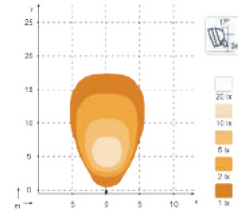

Flood

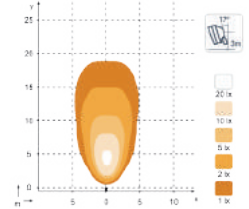

High Beam

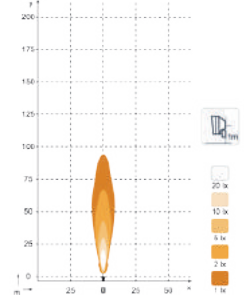

artikel / article	981-201B	981-202B	981-203B
lichtpatroon / courbe photométrique	wide flood	flood	high beam
lichtstroom / flux lumineux	700 Lm		
kleurtemperatuur / température de couleur	5700 K		
spanning / tension	9-110 Vdc		
vermogen / puissance	17 W		
stroom bij 24 V / courant à 24 V	0,7 A		
connector / connecteur	Deutsch (2 pinnen/broches)		
montage	1 bout / boulon M10		
schokbestendigheid / résistance aux chocs	60 G		
lens / lentille	transparant polycarbonaat / polycarbonate transparente		
behuizing / corps	aluminium		
gewicht / poids	900 g		
beschermingsgraad / indice de protection	IP68		
temperatuur / température	-40° +85° C		
	1		

- ▲ Werklichten voor zwaar rollend materieel
- ▲ Projecteurs de travail pour poids lourds

**NORDICLIGHTS** 

**KL1001**

Basismodel werklicht

Projecteur de travail modèle de base

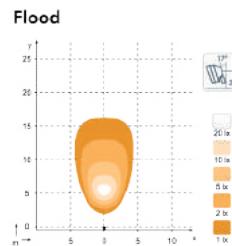
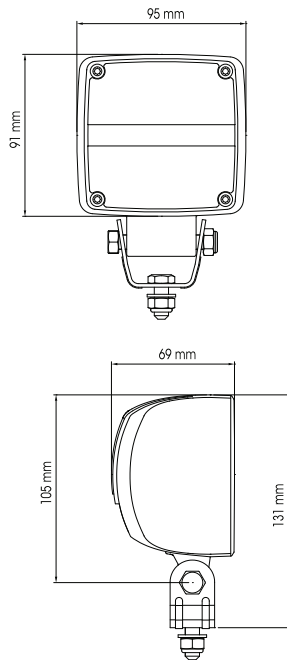

artikel / article	<b>982-101B</b>
lichtpatroon / courbe photométrique	flood
lichtstroom / flux lumineux	1000 Lm
kleurtemperatuur / température de couleur	5700 K
spanning / tension	9-32 Vdc
vermogen / puissance	24 W
stroom bij 24 V / courant à 24 V	1 A
connector / connecteur	draden / fils 300 mm
montage	1 bout / boulon M8
schokbestendigheid / résistance aux chocs	60 G
lens / lentille	transparant polycarbonaat / polycarbonate transparente
behuizing / corps	aluminium
gewicht / poids	700 g
beschermingsgraad / indice de protection	IP68
temperatuur / température	-40° +85° C
	1

- ▲ Werklichten voor zwaar rollend materieel
- ▲ Projecteurs de travail pour poids lourds



**NORDICLIGHTS** 

**N200 HID XD**

Xenon werklicht  
Projecteur de travail au xénon

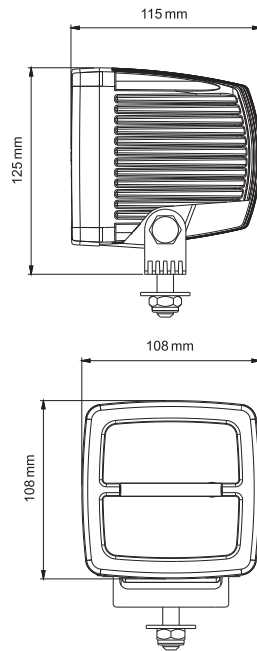

Wide Flood

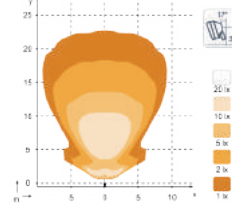

Flood

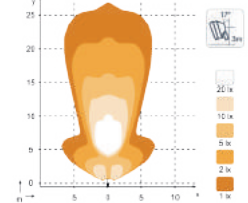

Low Beam

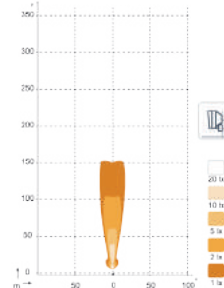

High Beam

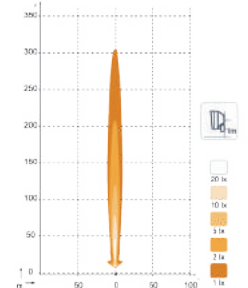

artikel / article	991-201	991-202	991-203	991-204
lichtpatroon / courbe photométrique	low beam	high beam	wide flood	flood
lichtstroom / flux lumineux	2500 Lm			
kleurtemperatuur / température de couleur	4250 K			
spanning / tension	16-32 Vdc			
vermogen / puissance	35 W			
stroom bij 24 V / courant à 24 V	1,7 A			
connector / connecteur	Deutsch (2 pinnen/broches)			
montage	1 bout/boulon M10			
schokbestendigheid / résistance aux chocs	60 G			
lens / lentille	gehard glas / verre trempé			
behuizing / corps	aluminium			
gewicht / poids	2400 g			
beschermingsgraad / indice de protection	IP68			
temperatuur / température	-40° +85° C			
	1			



▲ Werklamp  
▲ Projecteur de travail



**EW2461**

Oplaadbaar/magnetisch  
Rechargeable/magnétique

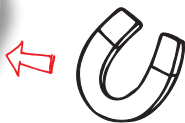

artikel article	omschrijving description	ladings chargeurs	
EW2461-EU	magnetische LED werklamp op batterij feu de travail à LED magnétique rechargeable	12/24 Vdc en/et 230 Vac	1
EW2461-MP	bevestigingsplaat voor EW2461-EU disque de montage pour EW2461-EU		1

**Technische data / Données techniques**

magnetisch	magnétique
oplaadbare Li-ion batterij 8,4 V - 4400mAh	batterie Li-ion rechargeable 8,4 V - 4400mAh
autonomie 4 uur	autonomie 4 heures
600 Lm - 15 W	600 Lm - 15 W
3 functies: 100% output, 30% output & SOS	3 fonctions d'opération: 100% output, 30% output & SOS
lens in polycarbonaat	lentille en polycarbonat
aluminium behuizing - Heavy Duty	corps en aluminium - Heavy Duty
waterdicht IP65	étanche IP65
CE	CE

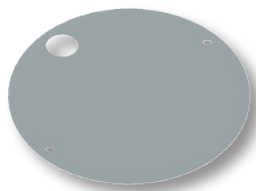
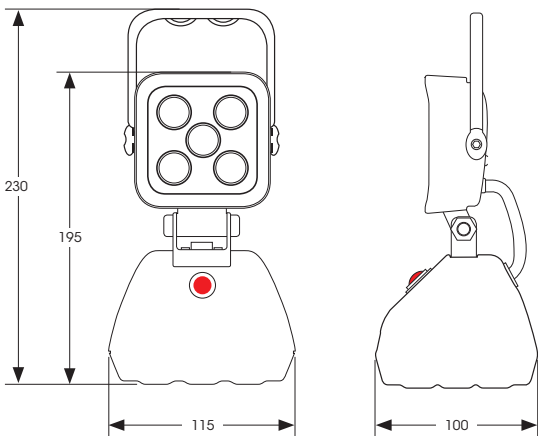

EW2461-MP

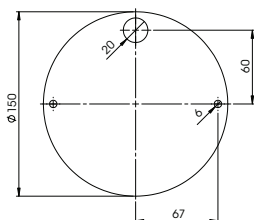



- ▲ Stekkers, koppelstekkers en stopcontacten
- ▲ Fiches mâles, fiches femelles et prises



# ABL

## HIGHTECH

Elamide stekkers & koppelstekkers

Fiches mâles et femelles en Elamid



artikel / article	1519100	1519140	1519150
kleur / couleur	●	●	●
omschrijving / description	Elamide stecker / fiche mâle en Elamid		
aansluiting / raccordement	3 x 2,5 mm <sup>2</sup>		
type	2-polig met aarding / 2 pôles avec terre, 16 A 250 V		
beschermingsgraad / indice de protection	IP44		
schokbestendigheid / résistance aux chocs'	IK08		
gewicht / poids	78 g		
norm / norme	IEC60889 / NBN C61-112		
pen- en randaarding double terre	✓		
	10		



artikel / article	1579202	1579242	1579252
kleur / couleur	●	●	●
omschrijving / description	Elamide koppelstecker / fiche femelle en Elamid		
aansluiting / raccordement	3 x 2,5 mm <sup>2</sup>		
type	2-polig met aarding / 2 pôles avec terre, 16 A 250 V		
beschermingsgraad / indice de protection	IP44		
schokbestendigheid / résistance aux chocs'	IK08		
gewicht / poids	98 g		
norm / norme	IEC60889 / NBN C61-112		
penaarding broche de terre	✓		
kinderbescherming éclipses de protection	✓		
afdichtingsring manchon d'étanchéité	✓		
deksel / couvercle	✓		
	10		

- ▲ Stekkers, koppelstekkers en stopcontacten
- ▲ Fiches mâles, fiches femelles et prises

# ABL

## PROFESSIONAL

Rubber stekkers & koppelstekkers

Fiches mâles et femelles en caoutchouc



artikel / article	1149190	1149290
kleur / couleur	●	●
omschrijving / description	rubber stekker fiche mâle en caoutchouc	volrubber stekker fiche mâle en caoutchouc plein
aansluiting / raccordement	3 x 2,5 mm <sup>2</sup>	
type	2-polig met aarding / 2 pôles avec terre, 16 A 250 V	
beschermingsgraad / indice de protection	IP44	
schokbestendigheid / résistance aux chocs'	IK08	
gewicht / poids	86 g	99 g
norm / norme	NBN C61-112	
pen- en randaarding double terre	✓	
	20	



artikel / article	1199592
kleur / couleur	●
omschrijving / description	rubber koppelstekker / fiche femelle en caoutchouc
aansluiting / raccordement	3 x 2,5 mm <sup>2</sup>
type	2-polig met aarding / 2 pôles avec terre, 16 A 250 V
beschermingsgraad / indice de protection	IP44
schokbestendigheid / résistance aux chocs'	IK08
gewicht / poids	170 g
norm / norme	NBN C61-112
penaarding broche de terre	✓
kinderbescherming éclipses de protection	✓
afdichtingsring manchon d'étanchéité	✓
deksel / couvercle	✓
	10

- ▲ Stekkers, koppelstekkers en stopcontacten
- ▲ Fiches mâles, fiches femelles et prises



# ABL

## PROFESSIONAL

Rubber stekkers & koppelstekkers

Fiches mâles et femelles en caoutchouc



artikel / article	1473597	1473692
kleur / couleur	●	●
omschrijving / description	3-weg rubber hangkoppeling prolongateur triplete en caoutchouc	
aansluiting / raccordement	3 x 2,5 mm <sup>2</sup>	
type	2-polig met aarding / 2 pôles avec terre, 16 A 250 V	
beschermingsgraad / indice de protection	IP44	
schokbestendigheid / résistance aux chocs'	IK08	
gewicht / poids	486 g	383 g
norm / norme	NBN C61-112	
penaarding broche de terre	✓	
kinderbescherming éclipses de protection	✓	
afdichtingsring manchon d'étanchéité	✓	
deksel / couvercle	✓	✓
draaibare klapdeksels clapets pivotant à ressorts	✓	✗
spanningscontrole indicateur de tension	✗	✓
	5	

- ▲ Stekkers, koppelstekkers en stopcontacten
- ▲ Fiches mâles, fiches femelles et prises

# ABL

## CLASSIC

Rubber en PVC- stekkers & koppelstekkers

Fiches mâles et femelles en caoutchouc et PVC



artikel / article	<b>1419190</b>	
kleur / couleur	●	
omschrijving / description	rubber stekker / fiche mâle en caoutchouc	
aansluiting / raccordement	3 x 1,5 mm <sup>2</sup>	
type	2-polig met aarding / 2 pôles avec terre, 16 A 250 V	
beschermingsgraad / indice de protection	IP44	
schokbestendigheid / résistance aux chocs'	IK08	
gewicht / poids	64 g	
norm / norme	NBN C61-112	
pen- en randaarding double terre	✓	
	20	



artikel / article	<b>1479292</b>	<b>1479092</b>
kleur / couleur	●	●
omschrijving / description	rubber koppelstekker / fiche femelle en caoutchouc	
aansluiting / raccordement	3 x 1,5 mm <sup>2</sup>	
type	2-polig met aarding / 2 pôles avec terre, 16 A 250 V	
beschermingsgraad / indice de protection	IP44	-
schokbestendigheid / résistance aux chocs'	IK08	
gewicht / poids	166 g	117 g
norm / norme	NBN C61-112	
penaarding broche de terre	✓	
kinderbescherming éclipses de protection	✓	
afdichtingsring manchon d'étanchéité	✓	✗
deksel / couvercle	✓	✗
	10	

- ▲ Stekkers, koppelstekkers en stopcontacten
- ▲ Fiches mâles, fiches femelles et prises



# ABL

## CLASSIC

Rubber en PVC- stekkers & koppelstekkers

Fiches mâles et femelles en caoutchouc et PVC



artikel / article	1418000	1418060	1418080
kleur / couleur	●	●	○
omschrijving / description	PVC-stekker / fiche mâle en PVC		
aansluiting / raccordement	3 x 1,5 mm <sup>2</sup>		
type	2-polig met aarding / 2 pôles avec terre, 16 A 250 V		
schokbestendigheid / résistance aux chocs'	IK08		
gewicht / poids	40 g		
norm / norme	NBN C61-112		
pen- en randaarding double terre	✓		
	20		



artikel / article	1679002	1679062	1679082
kleur / couleur	●	●	○
omschrijving / description	PVC-koppelstekker / fiche femelle en PVC		
aansluiting / raccordement	3 x 1,5 mm <sup>2</sup>		
type	2-polig met aarding / 2 pôles avec terre, 16 A 250 V		
schokbestendigheid / résistance aux chocs'	IK08		
gewicht / poids	83 g		
norm / norme	NBN C61-112		
penaarding broche de terre	✓		
kinderbescherming éclipses de protection	✓		
	10		

- ▲ Stekkers, koppelstekkers en stopcontacten
- ▲ Fiches mâles, fiches femelles et prises

# ABL

## BASIC

Thermoplastic stekkers

Fiches mâles thermoplastique

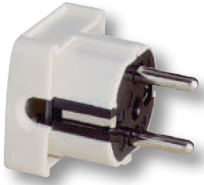



artikel / article	1400390	1400380
kleur / couleur	●	○
omschrijving / description	stekker met zijdelingse ingang fiche plate à sortie de câble latérale	
aansluiting / raccordement	3 x 1,5 mm <sup>2</sup>	
type	2-polig met aarding / 2 pôles avec terre, 16 A 250 V	
gewicht / poids	35 g	
norm / norme	NBN C61-112	
pen- en randaarding double terre	✓	
	20	

## 2505

Aansluitdozen voor huishoudtoestellen

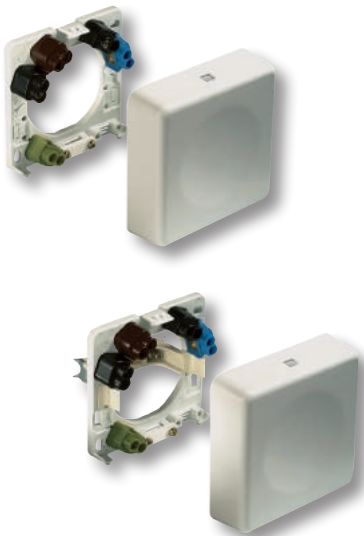
Boîtes de raccordement pour appareils électroménagers



artikel / article	2505110	2505210
kleur / couleur	○	○
inbouwmontage montage encastré	✓	✓
opbouwmontage montage en saillie	✓	✓
schroefklemmen bornes à vis	✓	✓
aansluiting / raccordement	5 x 2,5 mm / 6 mm <sup>2</sup>	
klemmenbeugel support à griffes	vast / fixe	klikbaar / cliquable
type	3P + N + T	
gewicht / poids	80 g	90 g
norm / norme	VDE0606	
	10	

- ▲ Stekkers, koppelstekkers en stopcontacten
- ▲ Fiches mâles, fiches femelles et prises



# ABL

**1662**

Inbouwstopcontacten  
Prises châssis



artikel / article	1662002	1662052	1662052/20	1662062
kleur / couleur	●	●	●	●
type	2-polig met aarding / 2 pôles avec terre, 16 A 250 V			
beschermingsgraad / indice de protection	IP54			
schokbestendigheid / résistance aux chocs'	IK08			
gewicht / poids	53 g			
norm / norme	NBN C61-112			
penaarding broche de terre		✓		
kinderbescherming éclipses de protection		✓		
deksel / couvercle		✓		
	100	100	20	100

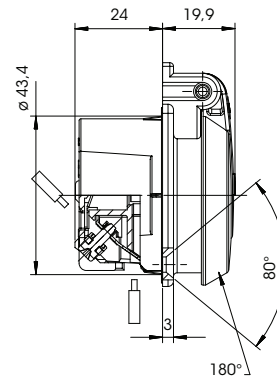
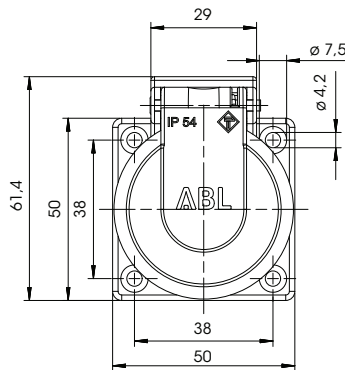

artikel article	omschrijving description	
8632316	rubber dichting voor de 1662 inbouwstopcontacten joint en caoutchouc pour les prises châssis 1662	10

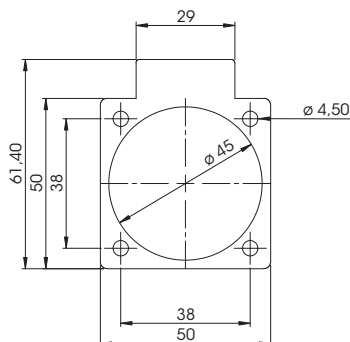



- ▲ Stekkers, koppelstekkers en stopcontacten
- ▲ Fiches mâles, fiches femelles et prises

# ABL

## BOWA94

Thermoplastic inbouwdoos met stopcontact  
Boîtier d'encastrement thermoplastique avec prise



artikel / article	1471602
type	2-polig met aarding / 2 pôles avec terre, 16 A 250 V
kabelingangen entrées de câble	2 x M20
gewicht / poids	125 g
norm / norme	NBN C61-112
penaarding broche de terre	✓
kinderbescherming éclipses de protection	✓
	1

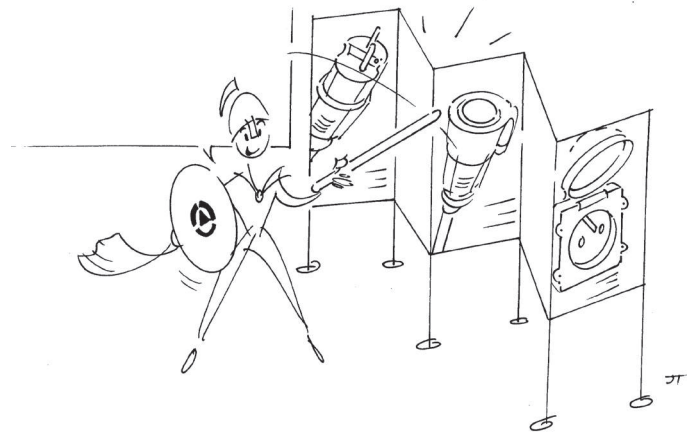
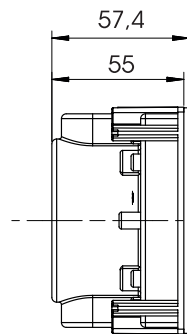
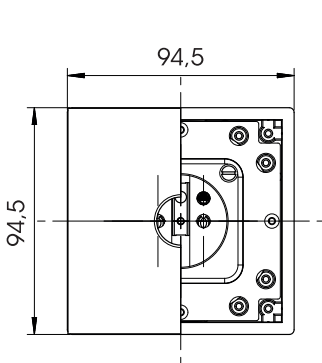

## BOWA94 METAL

Afdekplaat met klapdeksel  
Cadre avec couvercle



artikel / article	1471ESM	1471PLM	1471MSM
model / modèle	inox mat	platinum mat platine mat	messing mat laiton mat
beschermingsgraad / indice de protection	IP41		
gewicht / poids	315 g		
	1		



# ABL

**S** Stekkers  
 Fiches mâles



polen pôles	A ampère	schroefklemmen bornes à vis		schroefloze aansluiting connexion sans vis		schroefklemmen bornes à vis		
		230 V AC	400 V AC	230 V AC	400 V AC	230 V AC	400 V AC	
3	16	S31S20		S31SL20		S31S25		10
4	16		S41S30		S41SL30		S41S35	10
5	16		S51S30		S51SL30		S51S35	10
3	32	S32S20		S32SL20		S32S25		10
4	32		S42S30		S42SL30		S42S35	10
5	32		S52S30		S52SL30		S52S35	10



polen pôles	A ampère	schroefklemmen en vernikkelde contacten bornes à vis et contacts nickelés		
		230 V AC	400 V AC	
3	63	S33S25		2
4	63		S43S35	2
5	63		S53S35	2
5	125		S54S35	2

**G** Wandstekkers  
 Connecteurs muraux



polen pôles	A ampère	schroefklemmen bornes à vis		
		230 V AC	400 V AC	
3	16	G31S22		10
4	16		G41S32	10
5	16		G51S32	10
3	32	G32S22		10
4	32		G42S32	10
5	32		G52S32	10

**A** Inbouwstekkers  
 Connecteurs à encastrer



polen pôles	A ampère	met schroefklemmen bornes à vis 70 x 70		
		230 V AC	400 V AC	
3	16	A31S22		10
4	16		A41S32	10
5	16		A51S32	10
3	32	A32S22		10
4	32		A42S32	10
5	32		A52S32	10

**K** Koppelstekkers  
 Fiches femelles



polen pôles	A ampère	schroefklemmen bornes à vis		schroefloze aansluiting connexion sans vis		schroefklemmen bornes à vis		
		230 V AC	400 V AC	230 V AC	400 V AC	230 V AC	400 V AC	
3	16	K31S20		K31SL20		K31S25		10
4	16		K41S30		K41SL30		K41S35	10
5	16		K51S30		K51SL30		K51S35	10
3	32	K32S20		K32SL20		K32S25		10
4	32		K42S30		K42SL30		K42S35	10
5	32		K52S30		K52SL30		K52S35	10

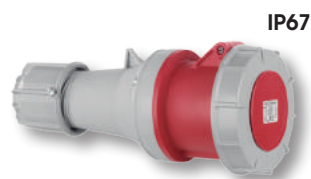

polen pôles	A ampère	schroefklemmen en vernikkelde contacten bornes à vis et contacts nickelés		
		230 V AC	400 V AC	
3	63	K33S25		2
4	63		K43S35	2
5	63		K53S35	2
5	125		K54S35	2



# ABL

**D** Wandstopcontacten  
 Prises murales



polen pôles	A ampère	schroefklemmen bornes à vis		schroefloze aansluiting connexion sans vis			schroefklemmen bornes à vis		
		230 V AC	400 V AC	230 V AC	400 V AC		230 V AC	400 V AC	
3	16	D31S21		D31SL20		10	D31S25		5
4	16		D41S31		D41SL30	10		D41S35	5
5	16		D51S31		D51SL30	10		D51S35	5
3	32	D32S21		D32SL20		10	D32S25		5
4	32		D42S31		D42SL30	10		D42S35	5
5	32		D52S31		D52SL30	10		D52S35	5

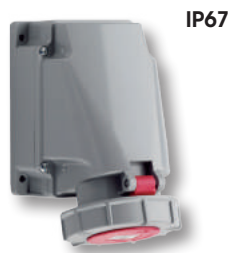

polen pôles	A ampère	schroefklemmen en vernikkelde contacten bornes à vis et contacts nickelés		
		230 V AC	400 V AC	
3	63	D33S26		2
4	63		D43S36	2
5	63		D53S36	2
5	125		D54S37	1

**F** Inbouwstopcontacten  
 Prises à encastrer



polen pôles	A ampère	schroefklemmen bornes à vis 70 x 70		schroefloze aansluiting connexion sans vis 75 x 75		schroefklemmen bornes à vis 75 x 75		
		230 V AC	400 V AC	230 V AC	400 V AC	230 V AC	400 V AC	
3	16	F31S201		F31SL21		F31S250		10
4	16		F41S301		F41SL31		F41S350	10
5	16		F51S301		F51SL31		F51S350	10
3	32	F32S201		F32SL21		F32S250		10
4	32		F42S301		F42SL31		F42S350	10
5	32		F52S301		F52SL31		F52S350	10

▲ Stekkerblokken, kunststof stekkers & koppelstekkers  
▲ Multiprises, fiches & fiches femelles plastique



**127** Standaard steckerblokken  
Multiprises standard



**Specificaties**

- kinderbeveiliging
- stecker met dubbele aarding
- dubbelpolige schakelaar 16 A met lampje

**Spécifications**

- éclipses de protection
- fiche avec double terre
- interrupteur bipolaire 16 A avec voyant

artikel article	stopcontacten 16 A prises 16 A	schakelaar interrupteur	kabellengte longueur câble	kabelsectie section câble	kleur couleur	l x b x h l x l x h	
127.10	3	✗	1,5 m	3G1	○	250,7 x 68,7 x 46 mm	10
127.11	3	✓	1,5 m	3G1	○	250,7 x 68,7 x 46 mm	10
127.12	4	✗	1,5 m	3G1	○	296,7 x 68,7 x 46 mm	10
127.13	4	✓	1,5 m	3G1	○	296,7 x 68,7 x 46 mm	10
127.14	5	✗	1,5 m	3G1	○	342,7 x 68,7 x 46 mm	10
127.15	5	✓	1,5 m	3G1	○	342,7 x 68,7 x 46 mm	10

**214** Kunststof stekkers en koppelstekkers 16 A met kinderbeveiliging  
Fiches et fiches femelles plastique 16 A avec éclipses de protection



artikel article	met ring avec anneau	kleur couleur	
214.08	✓	○	20
214.01	✓	●	20
214.06	✓	●	20
214.29	✓	○	20
214.25	✓	●	20
214.27	✓	●	20

**214.8** Dubbele rubber koppelstecker 16 A met kinderbeveiliging  
Fiche femelle double caoutchouc 16 A avec éclipses de protection



artikel article		
214.83	IP55	5

**101/104**

Adapters  
Adaptateurs



artikel article	van de	naar vers	
104.12	10 A pinnen Ø 4 mm 10 A broches Ø 4 mm	16 A pinnen Ø 4,8 mm 16 A broches Ø 4,8 mm	20
101.01	Schuko	Frans/Belgisch Français/Belge	10
101.12	Frans/Belgisch Français/Belge	Schuko	10
101.42	Frans/Belgisch Français/Belge	Brits Britannique	10
101.21	Frans/Belgisch - Schuko Français/Belge - Schuko	USA 125 V	10
101.22	Frans/Belgisch - Schuko Français/Belge - Schuko	USA 250 V	10
104.13	2 pinnen Ø 4 mm 2 broches Ø 4 mm	USA 125 V 2P	20

**117/118**

Stekkerblokken met kinderbeveiliging  
Multiprises avec éclipses de protection



artikel article	omschrijving description	
118.08	2 x 16 A 2P + aarding/terre	20
117.30	3 x 16 A 2P + aarding/terre	20

**363**

Campingadapter  
Adaptateur de camping



artikel article	omschrijving description	lengte longueur	
363.85	CEE-stekker mannelijk - koppelstekker 16 A 2P + aarding fiche mâle CEE - fiche femelle 16 A 2P + terre	300 mm	10



**325.1** Rechte coax connectors 75 ohms / 9,5 mm  
Connecteurs coaxiaux droits 75 ohms / 9,5 mm



artikel article	stekker fiche	koppelstekker fiche femelle	
325.12	✓	✗	20
325.18	✗	✓	20

**325.2** T-verbinders coax 75 ohms / 9,5 mm  
Tés de dérivation coaxiaux 75 ohms / 9,5 mm



artikel article	vrouwelijk femelle	mannelijk mâle	
325.20	1	2	10
325.23	2	1	10

**337/338** Connectors  
Connecteurs



artikel article	type type	vermogen puissance	spanning tension	temperatuur température	
337.01	C13	2300 W	230 V	max. 65° C	10
338.01	C15	2300 W	230 V	max. 120° C	10
338.21	C15 A recht/droit	2300 W	230 V	max. 155° C	10
338.20	C15 A haaks/coudé	2300 W	230 V	max. 155° C	10
337.05	C14	2300 W	230 V	max. 65° C	10
338.02	C16	2300 W	230 V	max. 120° C	10
338.22	C16 A	2300 W	230 V	max. 155° C	10



- ▲ Innovatieve IP68 waterdichte verbindingen en wartels
- ▲ Connectiques et presse-étoupes innovantes et IP68 étanches

**TH400**

2-weg all-round verbinder 32 A - 450 V  
Prolongateur all-round 32 A - 450 V

**IP68**  
5 bar



32 x 130 mm

artikel article	type	draadsectie section du conducteur	kabeldiameter diamètre de câble	temperatuur température	
TH400.B	5-polig 5 pôles	max. 4 mm <sup>2</sup>	5 - 17 mm	-40° C +125° C	1

**TH399**

Y-verbinder 32 A - 250 V  
Répartiteur en Y 32 A - 250 V

**IP68**  
2 bar



63 x 180 mm

artikel article	type	draadsectie section du conducteur	kabeldiameter diamètre de câble	temperatuur température	
TH399.B	3 + 3-polig 3 + 3 pôles	max. 4 mm <sup>2</sup>	5 - 17 mm	-40° C +125° C	1

**TH405**

Stekker en koppelstekker 25 A - 400 V  
Fiche mâle et femelle 25 A - 400 V

**IP68**  
1 bar



36,5 x 130 mm

artikel article	type	draadsectie section du conducteur	kabeldiameter diamètre de câble	temperatuur température	
TH405.B	3-polig 3 pôles	2,5 mm <sup>2</sup>	5 - 14 mm	-40° C +125° C	1

- ▲ Innovatieve IP68 waterdichte verbindingen en wartels
- ▲ Connectiques et presse-étoupes innovantes et IP68 étanches



### TH391

Mini-verbinder 17,5 A - 450 V  
Prolongateur mini 17,5 A - 450 V

IP68  
3 bar



23 x 68 mm

artikel article	type	draadsectie section du conducteur	kabeldiameter diamètre de câble	temperatuur température	
TH391.B	4-polig 4 pôles	max. 4 mm <sup>2</sup>	7 - 12 mm	-40° C +125° C	1

### TH392

H-verbinder 17,5 A - 450 V  
Répartiteur en H 17,5 A - 450 V

IP68  
3 bar



54 x 80 mm

artikel article	type	draadsectie section du conducteur	kabeldiameter diamètre de câble	temperatuur température	
TH392.B	4-polig 4 pôles	max. 4 mm <sup>2</sup>	8 - 12 mm	-40° C +125° C	1

Wartels M25 inclusief moeren - geen afzonderlijke dichting nodig

### TH450

Presse-étoupes M25 contre-écrous inclus - plus besoin du joint de surface séparé  
Wartels M16 inclusief moeren - geen afzonderlijke dichting nodig  
Presse-étoupes M16 contre-écrous inclus - plus besoin du joint de surface séparé

IP68  
5 bar



artikel article	kleur couleur	kabeldiameter diamètre de câble	temperatuur température	
TH450.B	 RAL 7035	4 - 9,5 mm	-40° C +125° C	5

- ▲ Innovatieve IP68 waterdichte verbindingen en wartels
- ▲ Connectiques et presse-étoupes innovantes et IP68 étanches



**TH451**

Wartels M20 inclusief moeren - geen afzonderlijke dichting nodig

Presses-étoupes M20 contre-écrous inclus - plus besoin du joint de surface séparé

**IP68**  
5 bar



artikel article	kleur couleur	kabeldiameter diamètre de câble	temperatuur température	
TH451.B	 RAL 7035	7 - 10,5 mm	-40° C +125° C	5



**TH452**

Wartels M25 inclusief moeren - geen afzonderlijke dichting nodig

Presses-étoupes M25 contre-écrous inclus - plus besoin du joint de surface séparé

**IP68**  
3 bar



artikel article	kleur couleur	kabeldiameter diamètre de câble	temperatuur température	
TH452.B	 RAL 7035	10,5 - 14 mm	-40° C +125° C	5

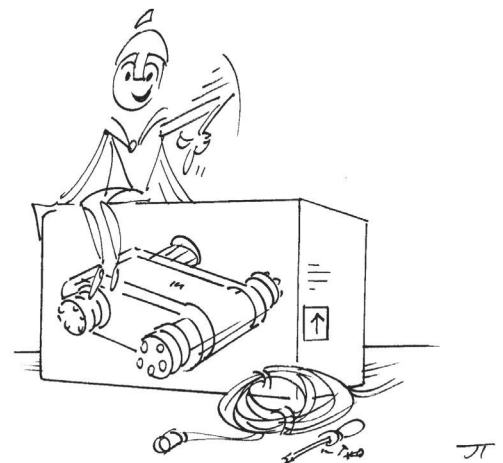

**3130** Zonder ring voor 13 mm diameter • Neon / Fluor  
Sans bague pour diamètre 13 mm • Néon / Fluor



	artikel article	spanning tension	stroom courant	
●	07-3130-1-230	230 Vac	< 1,5 mA	1
●	07-3130-3-230	230 Vac	< 1,5 mA	1
●	07-3130-4-230	230 Vac	< 1,5 mA	1
○	07-3130-5-230	230 Vac	< 1,5 mA	1

**3130-L** Zonder ring voor 13 mm diameter  
Sans bague pour diamètre 13 mm



	artikel article	spanning tension	stroom courant	
●	07-3130-L1-230	110 - 230 Vac	< 2,5 mA	1
●	07-3130-L2-230	110 - 230 Vac	< 2,5 mA	1
●	07-3130-L4-230	110 - 230 Vac	< 2,5 mA	1
○	07-3130-L6-230	110 - 230 Vac	< 2,5 mA	1
●	07-3130-L7-230	110 - 230 Vac	< 2,5 mA	1
●	07-3130-L1-028Z	28 - 50 Vac / dc	< 12 mA	1
●	07-3130-L2-028Z	28 - 50 Vac / dc	< 12 mA	1
●	07-3130-L4-028Z	28 - 50 Vac / dc	< 12 mA	1
○	07-3130-L6-028Z	28 - 50 Vac / dc	< 12 mA	1
●	07-3130-L7-028Z	28 - 50 Vac / dc	< 12 mA	1

- ▲ Signaallampen voor bordenbouw
- ▲ Voyants pour tableauxiers

**3135** Met chrome ring voor 13 mm diameter • Neon / Fluor  
 Avec bague chromée pour diamètre 13 mm • Néon / Fluor



	artikel article	spanning tension	stroom courant	
●	07-3135-1-230	230 Vac	< 1,5 mA	1
●	07-3135-3-230	230 Vac	< 1,5 mA	1
●	07-3135-4-230	230 Vac	< 1,5 mA	1
○	07-3135-5-230	230 Vac	< 1,5 mA	1

**3135-L** Met chrome ring voor 13 mm diameter  
 Avec bague chromée pour diamètre 13 mm



	artikel article	spanning tension	stroom courant	
●	07-3135-L1-230	110 - 230 Vac	< 2,5 mA	1
●	07-3135-L2-230	110 - 230 Vac	< 2,5 mA	1
●	07-3135-L4-230	110 - 230 Vac	< 2,5 mA	1
○	07-3135-L6-230	110 - 230 Vac	< 2,5 mA	1
●	07-3135-L7-230	110 - 230 Vac	< 2,5 mA	1
●	07-3135-L1-028Z	28 - 50 Vac / dc	< 12 mA	1
●	07-3135-L2-028Z	28 - 50 Vac / dc	< 12 mA	1
●	07-3135-L4-028Z	28 - 50 Vac / dc	< 12 mA	1
○	07-3135-L6-028Z	28 - 50 Vac / dc	< 12 mA	1
●	07-3135-L7-028Z	28 - 50 Vac / dc	< 12 mA	1

▲ Signaallampen voor bordenbouw  
▲ Voyants pour tableauxiers



**3160**

Met zwarte ring voor 16 mm diameter • Neon / Fluor  
Avec bague noire pour diamètre 16 mm • Néon / Fluor



	artikel article	spanning tension	stroom courant	
●	07-3160-1-230	230 Vac	< 1,5 mA	1
●	07-3160-3-230	230 Vac	< 1,5 mA	1
●	07-3160-4-230	230 Vac	< 1,5 mA	1
○	07-3160-5-230	230 Vac	< 1,5 mA	1

**3160-L**

Met zwarte ring voor 16 mm diameter  
Avec bague noire pour diamètre 16 mm



	artikel article	spanning tension	stroom courant	
●	07-3160-L1-230	110 - 230 Vac	< 2,5 mA	1
●	07-3160-L2-230	110 - 230 Vac	< 2,5 mA	1
●	07-3160-L4-230	110 - 230 Vac	< 2,5 mA	1
○	07-3160-L6-230	110 - 230 Vac	< 2,5 mA	1
●	07-3160-L7-230	110 - 230 Vac	< 2,5 mA	1
●	07-3160-L1-028Z	28 - 50 Vac / dc	< 12 mA	1
●	07-3160-L2-028Z	28 - 50 Vac / dc	< 12 mA	1
●	07-3160-L4-028Z	28 - 50 Vac / dc	< 12 mA	1
○	07-3160-L6-028Z	28 - 50 Vac / dc	< 12 mA	1
●	07-3160-L7-028Z	28 - 50 Vac / dc	< 12 mA	1

- ▲ Signaallampen voor bordenbouw
- ▲ Voyants pour tableaux

**3161** Met zilvergrijze ring voor 16 mm diameter • Neon / Fluor  
 Avec bague argentée pour diamètre 16 mm • Néon / Fluor



	artikel article	spanning tension	stroom courant	
●	07-3161-1-230	230 Vac	< 1,5 mA	1
●	07-3161-3-230	230 Vac	< 1,5 mA	1
●	07-3161-4-230	230 Vac	< 1,5 mA	1
○	07-3161-5-230	230 Vac	< 1,5 mA	1

**3161-L** Met zilvergrijze ring voor 16 mm diameter  
 Avec bague argentée pour diamètre 16 mm

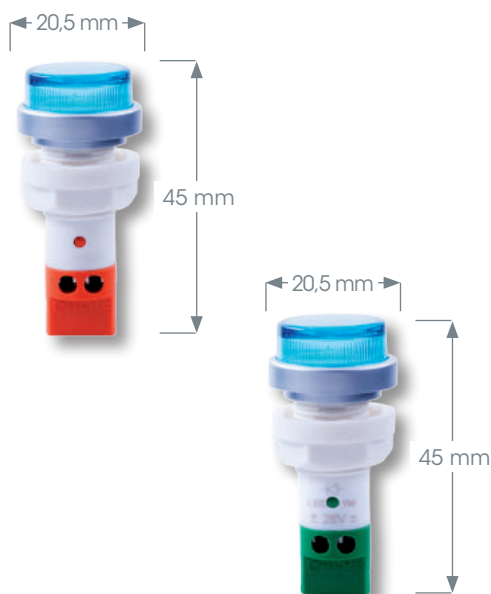

	artikel article	spanning tension	stroom courant	
●	07-3161-L1-230	110 - 230 Vac	< 2,5 mA	1
●	07-3161-L2-230	110 - 230 Vac	< 2,5 mA	1
●	07-3161-L4-230	110 - 230 Vac	< 2,5 mA	1
○	07-3161-L6-230	110 - 230 Vac	< 2,5 mA	1
●	07-3161-L7-230	110 - 230 Vac	< 2,5 mA	1
●	07-3161-L1-028Z	28 - 50 Vac / dc	< 12 mA	1
●	07-3161-L2-028Z	28 - 50 Vac / dc	< 12 mA	1
●	07-3161-L4-028Z	28 - 50 Vac / dc	< 12 mA	1
○	07-3161-L6-028Z	28 - 50 Vac / dc	< 12 mA	1
●	07-3161-L7-028Z	28 - 50 Vac / dc	< 12 mA	1



▲ Signaallampen voor bordenbouw  
▲ Voyants pour tableauxiers



**3220**

Met zwarte hoge ring voor 22,5 mm diameter • Neon / Fluor

Avec bague noire haute pour diamètre 22,5 mm • Néon / Fluor



	artikel article	spanning tension	stroom courant	
●	07-3220-1-230	230 Vac	< 1,5 mA	1
●	07-3220-3-230	230 Vac	< 1,5 mA	1
●	07-3220-4-230	230 Vac	< 1,5 mA	1
○	07-3220-5-230	230 Vac	< 1,5 mA	1

**3220-L**

Met zwarte hoge ring voor 22,5 mm diameter

Avec bague noire haute pour diamètre 22,5 mm

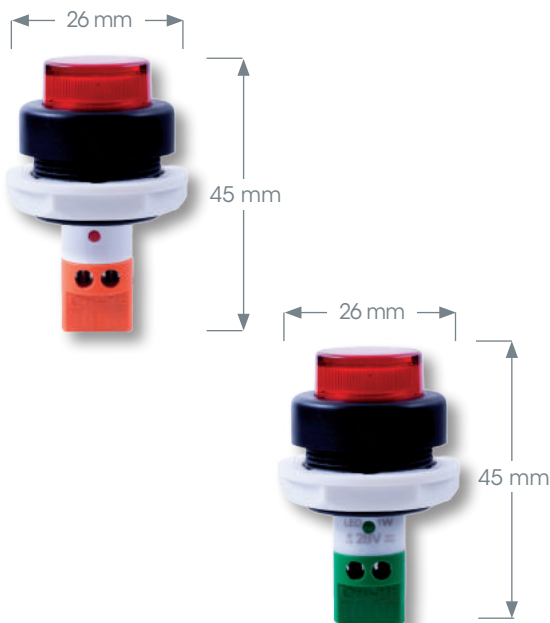

	artikel article	spanning tension	stroom courant	
●	07-3220-L1-230	110 - 230 Vac	< 2,5 mA	1
●	07-3220-L2-230	110 - 230 Vac	< 2,5 mA	1
●	07-3220-L4-230	110 - 230 Vac	< 2,5 mA	1
○	07-3220-L6-230	110 - 230 Vac	< 2,5 mA	1
●	07-3220-L7-230	110 - 230 Vac	< 2,5 mA	1
●	07-3220-L1-028Z	28 - 50 Vac / dc	< 12 mA	1
●	07-3220-L2-028Z	28 - 50 Vac / dc	< 12 mA	1
●	07-3220-L4-028Z	28 - 50 Vac / dc	< 12 mA	1
○	07-3220-L6-028Z	28 - 50 Vac / dc	< 12 mA	1
●	07-3220-L7-028Z	28 - 50 Vac / dc	< 12 mA	1

- ▲ Signaallampen voor bordenbouw
- ▲ Voyants pour tableaux

**3221**

Met zwarte lage ring voor 22,5 mm diameter • Neon / Fluor

Avec bague noire basse pour diamètre 22,5 mm • Néon / Fluor



	artikel article	spanning tension	stroom courant	
●	07-3221-1-230	230 Vac	< 1,5 mA	1
●	07-3221-3-230	230 Vac	< 1,5 mA	1
●	07-3221-4-230	230 Vac	< 1,5 mA	1
○	07-3221-5-230	230 Vac	< 1,5 mA	1

**3221-L**

Met zwarte lage ring voor 22,5 mm diameter

Avec bague noire basse pour diamètre 22,5 mm

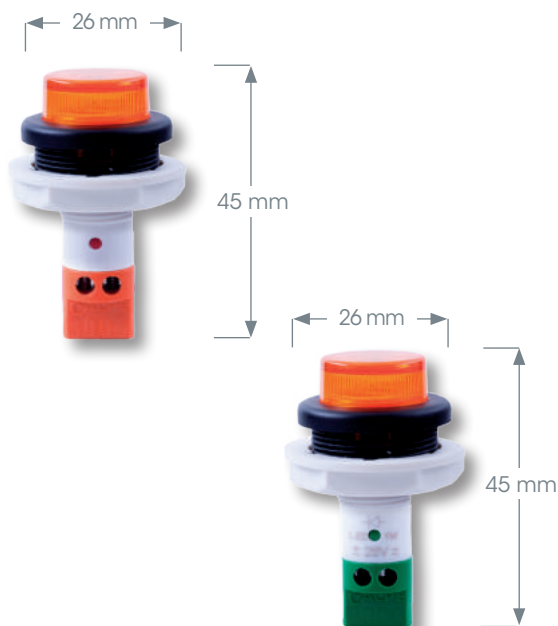



	artikel article	spanning tension	stroom courant	
●	07-3221-L1-230	110 - 230 Vac	< 2,5 mA	1
●	07-3221-L2-230	110 - 230 Vac	< 2,5 mA	1
●	07-3221-L4-230	110 - 230 Vac	< 2,5 mA	1
○	07-3221-L6-230	110 - 230 Vac	< 2,5 mA	1
●	07-3221-L7-230	110 - 230 Vac	< 2,5 mA	1
●	07-3221-L1-028Z	28 - 50 Vac / dc	< 12 mA	1
●	07-3221-L2-028Z	28 - 50 Vac / dc	< 12 mA	1
●	07-3221-L4-028Z	28 - 50 Vac / dc	< 12 mA	1
○	07-3221-L6-028Z	28 - 50 Vac / dc	< 12 mA	1
●	07-3221-L7-028Z	28 - 50 Vac / dc	< 12 mA	1

- ▲ Markering voor draad, kabel en elektrotechnische componenten
- ▲ Marquage pour fils, câbles et composants électrotechniques

# Grafoplast®

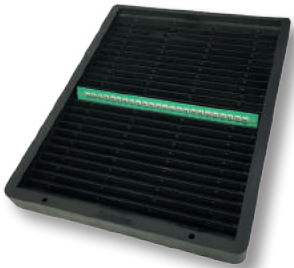
118



artikel article	omschrijving description	afmeting dimension	
118	Grafoplast™ TRASP houder Grafoplast™ TRASP support	147 x 190 x 18 mm	1

De houder is een essentieel onderdeel van het TRASP systeem. 25 strips met elementen worden er overzichtelijk in opgesteld, klaar voor gebruik.

Le support est une pièce essentielle du système TRASP. 25 barrettes avec éléments sont stockées visiblement et prêtes pour utilisation.

119



artikel article	omschrijving description	lengte longueur	
119 M/15	Grafoplast™ TRASP montagepen Grafoplast™ TRASP outil de montage	15 mm	1
119 M/30		30 mm	1

Met de montagepen kan u op de houder de nodige elementen selecteren en in de huls aanbrengen. Ze zijn beschikbaar in 2 lengtes: 15 mm (voor 6 elementen) en 30 mm (voor 13 elementen).

L'outil de montage permet de sélectionner les éléments nécessaires dans le support et les enfile dans le manchon. Ils sont disponibles en 2 longueurs: 15 mm (pour 6 éléments) et 30 mm (pour 13 éléments).

120



artikel article	omschrijving description	
120	Grafoplast™ TRASP demontagepen Grafoplast™ TRASP outil extracteur	5

Met de demontagepen kan u snel elementen verwijderen uit de huls.

Grâce à l'outil extracteur les éléments peuvent être enlevés rapidement du manchon.

- ▲ Markering voor draad, kabel en elektrotechnische componenten
- ▲ Marquage pour fils, câbles et composants électrotechniques



# Grafoplast®

## 23W

Grafoplast™ TRASP alfanumerieke elementen - witte achtergrond/zwarte tekst

Grafoplast™ TRASP éléments alphanumériques - fond blanc/texte noir

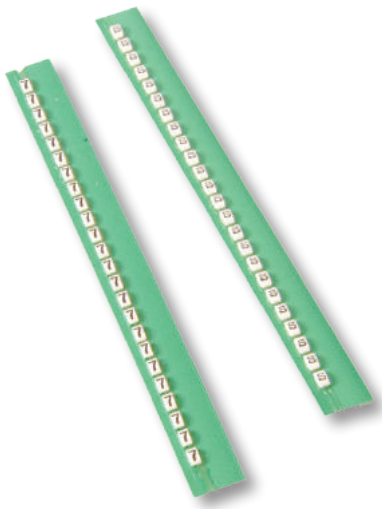

breedte  
largeur 2,3 mm



50 strips / barrettes

artikel article	karakter caractère	artikel article	karakter caractère	artikel article	karakter caractère
23 W 00	0	23 W F	F	23 W U	U
23 W 01	1	23 W G	G	23 W V	V
23 W 02	2	23 W H	H	23 W W	W
23 W 03	3	23 W I	I	23 W X	X
23 W 04	4	23 W J	J	23 W Y	Y
23 W 05	5	23 W K	K	23 W Z	Z
23 W 06	6	23 W L	L	23 W PLUS	+
23 W 07	7	23 W M	M	23 W MIN	-
23 W 08	8	23 W N	N	23 W AC	~
23 W 09	9	23 W O	O	23 W TE	⏚
23 W A	A	23 W P	P	23 W SS	/
23 W B	B	23 W Q	Q	23 W :	:
23 W C	C	23 W R	R	23 W =	=
23 W D	D	23 W S	S	23 W •	•
23 W E	E	23 W T	T	23 WIT	BLANCO

Elke strip bevat 24 elementen met gelijke karakters.

Chaque barrette comprend 24 éléments d'un même caractère

## 23G

Grafoplast™ TRASP alfanumerieke elementen - gele achtergrond/zwarte tekst

Grafoplast™ TRASP éléments alphanumériques - fond jaune/texte noir

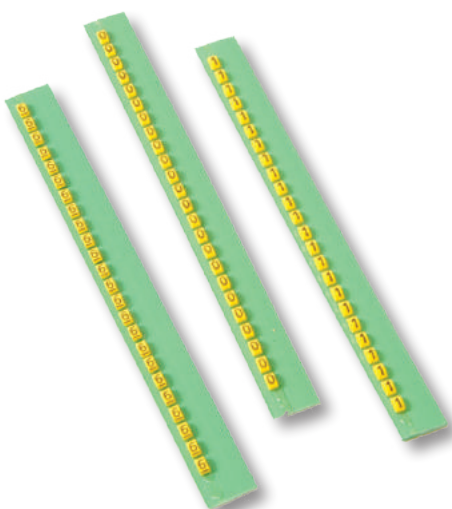

breedte  
largeur 2,3 mm



50 strips / barrettes

artikel article	karakter caractère	artikel article	karakter caractère	artikel article	karakter caractère
23 G 00	0	23 G F	F	23 G U	U
23 G 01	1	23 G G	G	23 G V	V
23 G 02	2	23 G H	H	23 G W	W
23 G 03	3	23 G I	I	23 G X	X
23 G 04	4	23 G J	J	23 G Y	Y
23 G 05	5	23 G K	K	23 G Z	Z
23 G 06	6	23 G L	L	23 G PLUS	+
23 G 07	7	23 G M	M	23 G MIN	-
23 G 08	8	23 G N	N	23 G AC	~
23 G 09	9	23 G O	O	23 G TE	⏚
23 G A	A	23 G P	P	23 G SS	/
23 G B	B	23 G Q	Q	23 G :	:
23 G C	C	23 G R	R	23 G =	=
23 G D	D	23 G S	S	23 G •	•
23 G E	E	23 G T	T	23 GEEL	BLANCO

Elke strip bevat 24 elementen met gelijke karakters.

Chaque barrette comprend 24 éléments d'un même caractère

- ▲ Markering voor draad, kabel en elektrotechnische componenten
- ▲ Marquage pour fils, câbles et composants électrotechniques

# Grafoplast®

200

Grafoplast™ TRASP hulzen

Grafoplast™ TRASP manchons



artikel article	min Ø	max Ø	lengte longueur	
201/10	1,5 mm	2,5 mm	10 mm	1000
201/15	1,5 mm	2,5 mm	15 mm	1000
201/23	1,5 mm	2,5 mm	23 mm	1000
201/30	1,5 mm	2,5 mm	30 mm	500
202/10	2 mm	4 mm	10 mm	1000
202/15	2 mm	4 mm	15 mm	1000
202/23	2 mm	4 mm	23 mm	500
202/30	2 mm	4 mm	30 mm	500
203/10	4 mm	7 mm	10 mm	500
203/15	4 mm	7 mm	15 mm	500
203/23	4 mm	7 mm	23 mm	500
203/30	4 mm	7 mm	30 mm	200
204/10	6 mm	10 mm	10 mm	500
204/15	6 mm	10 mm	15 mm	500
204/23	6 mm	10 mm	23 mm	200
204/30	6 mm	10 mm	30 mm	200
205/10	10 mm	14 mm	10 mm	200
205/15	10 mm	14 mm	15 mm	200
205/23	10 mm	14 mm	23 mm	200
205/30	10 mm	14 mm	30 mm	200
206/10	14 mm	22 mm	10 mm	200
206/15	14 mm	22 mm	15 mm	200
206/23	14 mm	22 mm	23 mm	100
206/30	14 mm	22 mm	30 mm	100
207/10	22 mm	30 mm	10 mm	50
207/15	22 mm	30 mm	15 mm	50
207/23	22 mm	30 mm	23 mm	50
207/30	22 mm	30 mm	30 mm	50
208/10	30 mm	35 mm	10 mm	50
208/15	30 mm	35 mm	15 mm	50
208/23	30 mm	35 mm	23 mm	50
208/30	30 mm	35 mm	30 mm	50
209/10	35 mm	40 mm	10 mm	50
209/15	35 mm	40 mm	15 mm	50
209/23	35 mm	40 mm	23 mm	50
209/30	35 mm	40 mm	30 mm	50

Deze transparante PVC-hulzen zijn zo ontworpen dat slechts 9 maten nodig zijn om alle draad- en kabeldiameters van 1,5 tot 40 mm te bestrijken.

Ces manchons transparents sont développés de telle façon que seulement 9 tailles sont nécessaires pour enfiler tous fils et câbles de diamètres de 1,5 à 40 mm

- ▲ Markering voor draad, kabel en elektrotechnische componenten
- ▲ Marquage pour fils, câbles et composants électrotechniques



# Grafoplast®

**001SK/02**

Grafoplast™ TRASP starter kit



Een draagbare kit met alles wat u nodig hebt om handmatig markeringen te maken.  
Afmeting: 280 x 320 x 170 mm

Un kit portable pour le marquage manuel.  
Dimension: 280 x 320 x 170 mm

inhoud contenu	aantal quantité	inhoud contenu	aantal quantité	inhoud contenu	aantal quantité
23 W 00	10	23 W H	10	23 W Y	10
23 W 01	10	23 W I	10	23 W Z	10
23 W 02	10	23 W J	10	23 W PLUS	10
23 W 03	10	23 W K	10	23 W MIN	10
23 W 04	10	23 W L	10	23 W TE	10
23 W 05	10	23 W M	10	23 W SS	10
23 W 06	10	23 W N	10	23 W ZWART	10
23 W 07	10	23 W O	10	23 W ROOD	10
23 W 08	10	23 W P	10	23 W GROEN	10
23 W 09	10	23 W Q	10	23 W GEEL	10
23 W A	10	23 W R	10	23 W BLAUW	10
23 W B	10	23 W S	10	118	1
23 W C	10	23 W T	10	119 M/15	1
23 W D	10	23 W U	10	119 M/30	1
23 W E	10	23 W V	10	120	1
23 W F	10	23 W W	10	202/15	1000
23 W G	10	23 W X	10		

**050A**

Grafoplast™ TRASP koffer

Grafoplast™ TRASP coffret



Handige koffer met alle gereedschap en voldoende plaats voor elementen en hulzen om uw persoonlijke kit samen te stellen.

Afmeting: 350 x 80 x 250 mm

Coffret pratique avec outils et compartiments suffisants pour éléments et manchons vous permettant la personnalisation.

Dimension: 350 x 80 x 250 mm

inhoud contenu	omschrijving description	aantal quantité
118	houder support	2
119 M/15	montagepen 15 mm outil de montage 15 mm	1
119 M/30	montagepen 30 mm outil de montage 30 mm	1
120	demontagepen outil extracteur	1

**230V** Zelfklever  
Autocollant



**230V**

artikel article	h x b h x l	
230V	35 x 70 mm	100

**240V** Zelfklevers  
Autocollants



**3x240V**

artikel article	h x b h x l	
3x240V	35 x 70 mm	100

**3x240V 50HZ**

3x240V50	30 x 130 mm	10
----------	-------------	----

**400V** Zelfklevers  
Autocollants



**400V**

artikel article	h x b h x l	
400V	35 x 70 mm	100

**3x400V**

3x400V	35 x 70 mm	100
--------	------------	-----

**3x400V+N**

3x400VN	35 x 70 mm	100
---------	------------	-----

**3x400V+N**

3x400VNG	30 x 130 mm	10
----------	-------------	----





**8** Zelfklevers  
Autocollants



**230 Volt**

**230Volt**

**400Volt**

**400Volt**

artikel article	h x b h x l	
83K1	18 x 37 mm	10
83K2	26 x 52 mm	10
84K1	18 x 37 mm	10
84K2	26 x 52 mm	10

**F** Acrylic zelfklevers op kaart, PVC- en halogeen vrij  
Autocollants en acrylic sans PVC ou halogène sur carte



artikel article	h x b h x l	
F25x25	25 x 25 mm	140
F50x50	50 x 50 mm	70
F100x100	100 x 100 mm	30
F200x200	200 x 200 mm	10

**W** Zelfklevers  
Autocollants



artikel article	h x b h x l	
W125	25 x 25 mm	500
W150	50 x 50 mm	500
W1100	100 x 100 mm	500

**L** Zelfklevers op kaart  
Autocollants sur carte



artikel article	∅	
L1	16 mm	10
L2	16 mm	10
L3	16 mm	10

**N** Zelfklever op kaart  
Autocollant sur carte



artikel article	∅	
N	16 mm	10

**TE** Zelfklever op kaart  
Autocollant sur carte



artikel article	∅	
TE12	12 mm	12
TE16	16 mm	10



**PE** Zelfklevers op kaart  
Autocollants sur carte



artikel article	∅	
PE.12.5	12,5 mm	12
PE.16	16 mm	10
PE.20	20 mm	9

**PEN** Zelfklever op kaart  
Autocollant sur carte



artikel article	∅	
PEN	16 mm	10

▲ Adereindhulzen  
▲ Embouts de câble

**G** Geïsoleerde adereindhulzen  
Embouts de câble isolés



mm <sup>2</sup>	lengte longueur	artikel article	DIN	artikel article	T	artikel article	W	
0,14	6	G0.14	●	G0.14T	●	G0.14	●	100
	8	G0.14L	●	G0.14TL	●	G0.14L	●	100
0,25	6	G0.25D	●	G0.25T	●	G0.25	●	100
	8	G0.25DL	●	G0.25TL	●	G0.25L	●	100
0,34	6	G0.34	●	G0.34T	●	G0.34	●	100
	8	G0.34L	●	G0.34TL	●	G0.34L	●	100
0,50	6	G0.5TK	○	G0.5TK	○	G0.5K	●	100
	8	G0.5T	○	G0.5T	○	G0.5	●	100
	10	G0.5TL	○	G0.5TL	○	G0.5L	●	100
0,75	6	G0.75DK	●	G0.75TK	●	G0.75K	○	100
	8	G0.75D	●	G0.75T	●	G0.75	○	100
	10	G0.75DHL	●	G0.75THL	●	G0.75HL	○	100
	12	G0.75DL	●	G0.75TL	●	G0.75L	○	100
1,00	6	G1TK	●	G1TK	●	G1K	●	100
	8	G1T	●	G1T	●	G1	●	100
	10	G1THL	●	G1THL	●	G1HL	●	100
	12	G1TL	●	G1TL	●	G1L	●	100
1,50	6	G1.5TK	●	G1.5TK	●	G1.5K	●	100
	8	G1.5T	●	G1.5T	●	G1.5	●	100
	10	G1.5THL	●	G1.5THL	●	G1.5HL	●	100
	12	G1.5TS.	●	G1.5TS.	●	G1.5S.	●	100
	18	G1,5TL	●	G1,5TL	●	G1,5L	●	100
2,50	8	G2.5	●	G2.5T	●	G2.5	●	100
	10	G2.5S.	●	G2.5TS.	●	G2.5S.	●	100
	12	G2.5M	●	G2.5TM	●	G2.5M	●	100
	18	G2,5L	●	G2,5TL	●	G2,5L	●	100
4,00	10	G4	●	G4T	●	G4	●	100
	12	G4M	●	G4TM	●	G4M	●	100
	18	G4L	●	G4TL	●	G4L	●	100
6,00	12	G6D	●	G6T	●	G6	●	100
	18	G6DL	●	G6TL	●	G6L	●	100
10,00	12	G10D	●	G10T	●	G10	●	100
	18	G10DL	●	G10TL	●	G10L	●	100
16,00	12	G16D	●	G16T	○	G16	●	100
	18	G16DL	●	G16TL	○	G16L	●	100
25,00	16	G25D	●	G25T	●	G25	●	50
	18	G25DM	●	G25TM	●	G25M	●	50
	22	G25DL	●	G25TL	●	G25L	●	50



**G** Geïsoleerde adereindhulzen  
Embouts de câble isolés



mm <sup>2</sup>	lengte longueur	artikel article	DIN	artikel article	T	artikel article	W	
35,00	16	G35T	●	G35T	●	G35	●	50
	18	G35TM	●	G35TM	●	G35M	●	50
	25	G35TL	●	G35TL	●	G35L	●	50
50,00	20	G50T	●	G50T	●	G50	●	50
	25	G50TL	●	G50TL	●	G50L	●	25
70,00	20	G70	●	G70	●	G70	●	25
	27	G70L	●	G70L	●	G70L	●	25
95,00	25	G95D	●	G95	●	G95	●	25
120,00	27	G120D	●	G120	●	G120	●	25
150,00	32	G150D	●	G150	●	G150	●	25

**O** Niet-geïsoleerde adereindhulzen  
Embouts de câble non isolés



mm <sup>2</sup>	lengte longueur	artikel article	
0,25	5	G0.25.5	1000
	7	G0.25.7	1000
0,34	5	G0.34.5	1000
	7	G0.34.7	1000
0,50	6	G0.5.6	1000
	8	G0.5.8	1000
	10	G0.5.10	1000
0,75	6	G0.75.6	1000
	8	G0.75.8	1000
	10	G0.75.10	1000
	12	G0.75.12	1000
1,00	6	G1.6	1000
	7	G1.7	1000
	8	G1.8	1000
	10	G1.10	1000
1,50	12	G1.12	1000
	7	G1.5.7	1000
	8	G1.5.8	1000
	10	G1.5.10	1000
	12	G1.5.12	1000
	15	G1.5.15	1000
	18	G1.5.18	1000
20	G1.5.20	1000	

- ▲ Adereindhulzen
- ▲ Embouts de câble

○ Niet-geïsoleerde adereindhulzen  
Embouts de câble non isolés

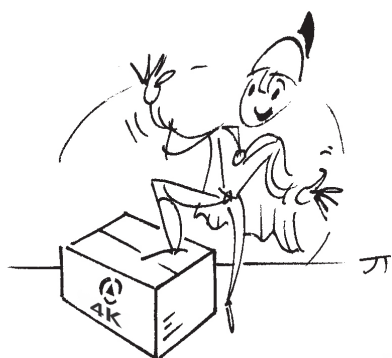

Groot aanbod / Grand choix

mm <sup>2</sup>	lengte longueur	artikel article	
2,50	7	G2.5.7	1000
	8	G2.5.8	1000
	10	G2.5.10	1000
	12	G2.5.12	1000
	15	G2.5.15	1000
	18	G2.5.18	1000
4,00	20	G2.5.20	1000
	9	G4.9	1000
	10	G4.10	1000
	12	G4.12	1000
	15	G4.15	1000
	18	G4.18	1000
6,00	20	G4.20	1000
	10	G6.10	1000
	12	G6.12	1000
	15	G6.15	1000
10,00	18	G6.18	1000
	20	G6.20	1000
	12	G10.12	500
	15	G10.15	500
	18	G10.18	500
16,00	20	G10.20	500
	25	G10.25	500
	12	G16.12	250
	15	G16.15	250
	18	G16.18	250
	20	G16.20	250
25,00	25	G16.25	250
	32	G16.32	250
	12	G25.12	100
	15	G25.15	100
	18	G25.18	100
35,00	25	G25.25	100
	32	G25.32	100
	18	G35.18	100
	20	G35.20	100
	25	G35.25	100
	32	G35.32	100

▲ Adereindhulzen  
▲ Embouts de câble



**GLW**  
Crimping Technology





















































**G** Niet-geïsoleerde adereindhulzen  
Embouts de câble non isolés



mm <sup>2</sup>	lengte longueur	artikel article	
50,00	18	G50.18	100
	22	G50.22	100
	25	G50.25	100
70,00	32	G50.32	100
	25	G70.25	100
95,00	32	G70.32	100
	25	G95.25	50
	30	G95.30	50
120,0	32	G95.32	50
	32	G120.32	50
150,0	40	G120.40	50
	32	G150.32	50
185,0	38	G150.38	50
	32	G185.32	25
	40	G185.40	25

**T** Geïsoleerde twinadereindhulzen  
Embouts de câble isolés pour deux conducteurs



mm <sup>2</sup>	lengte longueur	artikel article	DIN	artikel article	T	artikel article	W	
2 x 0,5	6	T0.5TK		T0.5TK		T0.5K		100
	8	T0.5T		T0.5T		T0.5		100
	10	T0.5TL		T0.5TL		T0.5L		100
2 x 0,75	8	T0.75D		T0.75T		T0.75		100
	12	T0.75DL		T0.75TL		T0.75L		100
2 x 1,0	8	T1T		T1T		T1		100
	12	T1TL		T1TL		T1L		100
2 x 1,5	8	T1.5T		T1.5T		T1.5		100
	12	T1.5TL		T1.5TL		T1.5L		100
2 x 2,5	10	T2.5		T2.5T		T2.5		100
	13	T2.5L		T2.5TL		T2.5L		100
2 x 4,0	12	T4		T4T		T4		100
	18	T4L		T4TL		T4L		100
2 x 6,0	14	T6D		T6T		T6		100
	18	T6DL		T6TL		T6L		100
2 x 10,0	14	T10D		T10T		T10		100
2 x 16,0	16	T16D		T16T		T16		50



▲ Adereindhulzen  
▲ Embouts de câble



**G** Adereindhulzen op rol

Embouts de câble en chenilles



mm <sup>2</sup>	lengte longueur	artikel article	DIN	artikel article	T	artikel article	W	
0.25	8	G0.25DR	●			G0.25R	●	1000
0.34	8	G0.34R	●			G0.34R	●	1000
0.5	8	G0.5TR	○	G0.5TR	○	G0.5R	●	1000
0.75	8	G0.75DR	●	G0.75TR	●	G0.75R	○	1000
1	8	G1TR	●	G1TR	●	G1R	●	1000
1.5	8	G1.5TR	●	G1.5TR	●	G1.5R	●	1000
2.5	8	G2.5R	●	G2.5TR	●	G2.5R	●	500

**MC 25** Elektrische krimp- en stripmachine

Machine électrique à sertir et à dénuder

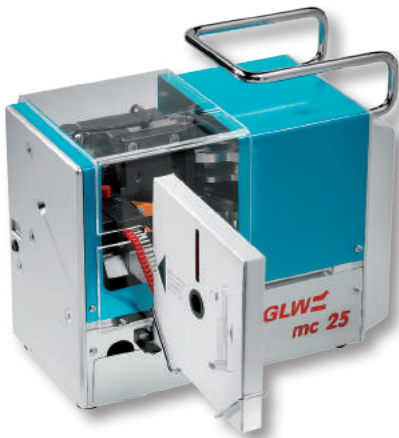

Technische data / Données techniques

artikel - article	MC 25
draadsecties - section de fil	(0,25) 0,5 - 2,5 mm <sup>2</sup>
striplengte - longueur retractée	8 mm
cyclustijd - temps de cycle	1,5 s
stukteller - compteur de pièces	LCD scherm - Ecran LCD
netspanning - AC	230 V / 50 Hz
afmeting (bxhxd) - dimension (lxhxp)	165 x 270 x 320 mm
gewicht - poids	12 kg

**Snelle en precieze verwerking van adereindhulzen**

- Eenvoudige bediening
- Geruisloos
- Vlug wisselen tussen draadsecties
- Handig inzetbaar op locatie

**Toepassingsgebied**

- Draad- en kabelconfectie
- Kastenbouw
- Productielijnen
- Werkplaatsen

**Toebehoren**

- Uitbreiding voor 0,25/0,34 mm<sup>2</sup>

**Processus rapide et précis des embouts**

- Utilisation simple
- Silencieuse
- Changement rapide entre section de câble
- Montage sur site

**Applications**

- Confection de câbles
- Tableautiers
- Lignes de production
- Chantiers

**Accessoires**

- Extension pour 0,25/0,34 mm<sup>2</sup>



**100** EASY lusterklemmen  
EASY raccords lustre



artikel article	kabelsectie section de câble	stroom courant	spanning tension	polen pôles	kleur couleur	temp.	
104	2,5 mm <sup>2</sup>	24 A	450 V	12		110° C	10
106	6 mm <sup>2</sup>	41 A	450 V	12		110° C	10
110	10 mm <sup>2</sup>	57 A	450 V	12		110° C	10
116	16 mm <sup>2</sup>	76 A	450 V	12		110° C	10
135	35 mm <sup>2</sup>	125 A	450 V	12		110° C	10

**Technische data / Données techniques**

lichaam / corps	polyamide 6, V2 (UL94)
kern / plot	messing vernikkeld / laiton nickelé
vijzen / vis	verzinkt staal / acier zingué

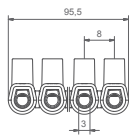

104

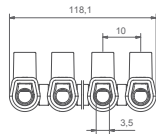

106

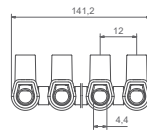

110

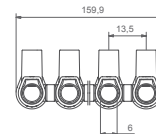

116

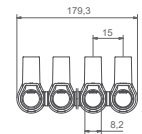

135

**1000** Koppelbare lusterklemmen (♂+♀)  
Raccords lustre enfilables (♂+♀)

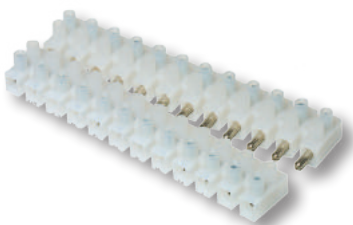

artikel article	kabelsectie section de câble	stroom courant	spanning tension	polen pôles	kleur couleur	temp.	
1804 E-N-C	2,5 mm <sup>2</sup>	6 A	450 V	12		110° C	10
1006 E-N-C	6 mm <sup>2</sup>	10 A	450 V	12		110° C	10
1010 E-N-C	10 mm <sup>2</sup>	16 A	450 V	12		110° C	10

**Technische data / Données techniques**

lichaam / corps	polyamide 6, V2 (UL94)
kern / plot	messing vernikkeld / laiton nickelé
vijzen / vis	verzinkt staal / acier zingué

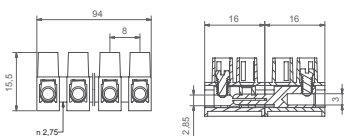

1804 E-N-C

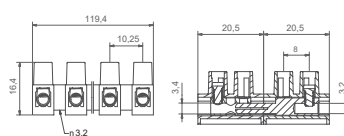



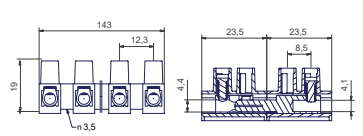



1006 E-N-C

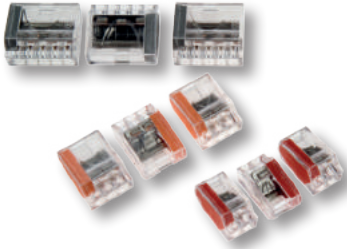

1010 E-N-C

**3500** Veerklemmen  
Bornes sans vis











artikel article	kabelsectie section de câble	stroom courant	spanning tension	polen pôles	kleur couleur	temp.	
3502M	1 - 2,5 mm <sup>2</sup>	24 A	450 V	2		85° C	100
3503M	1 - 2,5 mm <sup>2</sup>	24 A	450 V	3		85° C	100
3504M	1 - 2,5 mm <sup>2</sup>	24 A	450 V	4		85° C	100
3505M	1 - 2,5 mm <sup>2</sup>	24 A	450 V	5		85° C	100
3508M	1 - 2,5 mm <sup>2</sup>	24 A	450 V	8		85° C	50

**Technische data / Données techniques**

lichaam / corps	polycarbonaat / polycarbonate V0
klemmen / bornes	roestvast staal / acier inoxydable

**HPS** Aftakklemmen  
Bornes de dérivation



artikel article	kabelsectie section de câble	stroom courant	spanning tension	polen pôles	kleur couleur	temp.	
HPS 6	6 mm <sup>2</sup>	41 A	500 V	12		110° C	10
HPS 10	10 mm <sup>2</sup>	57 A	500 V	12		110° C	10
HPS 16	16 mm <sup>2</sup>	76 A	500 V	12		110° C	10
HPS 25/35	25/35 mm <sup>2</sup>	125 A	500 V	12		110° C	10
HPS 50	50 mm <sup>2</sup>	150 A	1000 V	1		110° C	30
HPS 70	70 mm <sup>2</sup>	192 A	1000 V	1		110° C	30
HPS 95	95 mm <sup>2</sup>	232 A	1000 V	1		110° C	30
HPS 120	120 mm <sup>2</sup>	269 A	1000 V	1		110° C	30

**Technische data / Données techniques**

lichaam / corps	polyamide 6 V2
kern / plot	messing vernikkeld / laiton nickelé
vijzen / vis	messing vernikkeld / laiton nickelé



**B** Porseleinen klemmen  
Raccords en porcelaine



artikel article	kabelsectie section de câble	specificaties spécifications	polen pôles	kleur couleur	temp.	
B4-1E	4 mm <sup>2</sup>	32 A - 450 V	1		350° C	200
B6-1E	6 mm <sup>2</sup>	41 A - 450 V	1		350° C	150
B10-1E	10 mm <sup>2</sup>	57 A - 450 V	1		350° C	125
B16-1E	16 mm <sup>2</sup>	76 A - 450 V	1		350° C	75
B4-2E	4 mm <sup>2</sup>	32 A - 450 V	2		350° C	100
B6-2E	6 mm <sup>2</sup>	41 A - 450 V	2		350° C	75
B10-2E	10 mm <sup>2</sup>	57 A - 450 V	2		350° C	60
B16-2E	16 mm <sup>2</sup>	76 A - 450 V	2		350° C	25
B4-3E	4 mm <sup>2</sup>	32 A - 450 V	3		350° C	50
B6-3E	6 mm <sup>2</sup>	41 A - 450 V	3		350° C	50
B10-3E	10 mm <sup>2</sup>	57 A - 450 V	3		350° C	40
B16-3E	16 mm <sup>2</sup>	76 A - 450 V	3		350° C	25
B4-4E	4 mm <sup>2</sup>	32 A - 450 V	4		350° C	50
B6-4E	6 mm <sup>2</sup>	41 A - 450 V	4		350° C	40
B10-4E	10 mm <sup>2</sup>	57 A - 450 V	4		350° C	30
B16-4E	16 mm <sup>2</sup>	76 A - 450 V	4		350° C	15

**Technische data / Données techniques**

lichaam / corps	porselein / porcelaine
kern / plot	messing vernikkeld / laiton nickelé
vijzen / vis	verzinkt staal / acier zingué

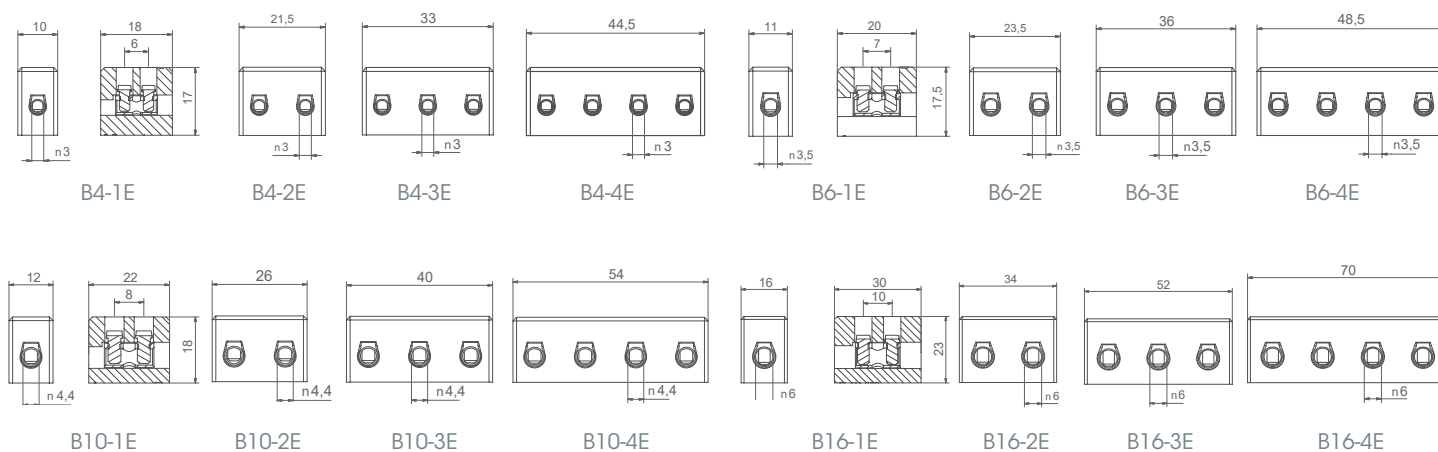







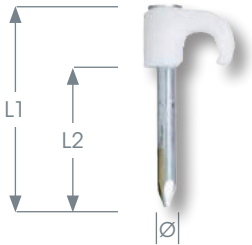

- ▲ Installatiemateriaal voor kabelbevestiging
- ▲ Matériel de fixation pour câbles

### THORSMAN TC

Ronde nagelklemmen uit PP en gegalvaniseerd gehard staal, UV-bestendig en halogeenvrij  
Clips ronds en PP avec clou en acier galvanisé, résistant aux UV, sans halogène







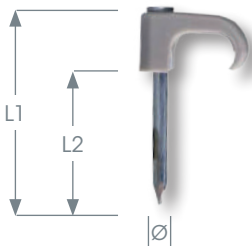

artikel article	Ø / L1 / L2	kleur couleur	temperatuur température	
TC 3-5N	1,2 / 20 / 15 mm		-40° +80° C	100
TC 5-7V	1,2 / 20 / 12 mm		-40° +80° C	100
TC 7-10LG	1,6 / 25 / 16 mm		-40° +80° C	100
TC 10-14LG	2,0 / 30 / 17 mm		-40° +80° C	100
TC 14-20LG	2,0 / 35 / 18 mm		-40° +80° C	100
TC 18-22LG	2,5 / 45 / 25 mm		-40° +80° C	50
TC 22-26LG	2,5 / 45 / 21 mm		-40° +80° C	50

### THORSMAN TC

Platte nagelklemmen uit PP en gegalvaniseerd gehard staal, UV-bestendig en halogeenvrij  
Clips plats en PP avec clou en acier galvanisé, résistant aux UV, sans halogène





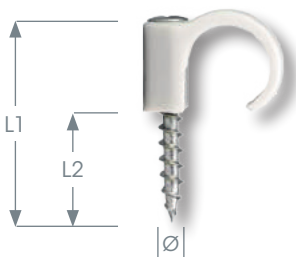

artikel article	Ø / L1 / L2	kleur couleur	temperatuur température	
TC 2x4N	1,4 / 15 / 11 mm		-40° +80° C	100
TC 4x6N	1,4 / 20 / 14 mm		-40° +80° C	100
TC 5x8V	2,0 / 25 / 18 mm		-40° +80° C	100
TC 6x10V	2,0 / 25 / 17 mm		-40° +80° C	100
TC 7x14V	2,5 / 25 / 16 mm		-40° +80° C	100

### THORSMAN TCS

Ronde schroefklemmen uit PP en gegalvaniseerd staal, UV-bestendig  
Clips ronds en PP avec vis PH2 en acier galvanisé, résistant aux UV



artikel article	Ø / L1 / L2	kleur couleur	temperatuur température	
TCS-C3 10-14	5 / 38 / 26 mm		-40° +80° C	100
TCS-C3 14-18	5 / 38 / 23 mm		-40° +80° C	100
TCS-C3 18-22	5 / 41 / 23 mm		-40° +80° C	50
TCS-C3 22-26	5 / 45 / 23 mm		-40° +80° C	50



- ▲ Installatiemateriaal voor kabelbevestiging
- ▲ Matériel de fixation pour câbles

### THORSMAN TET

Doorvoertules uit EPDM  
Passe-fils en EPDM

IP67







artikel article	Ø x h Ø x p	Ø gat Ø trou	kleur couleur	temperatuur température	
TET 5-7	21 x 18 mm	16 mm		-40° +100° C	50
TET 7-10	24 x 20 mm	19 mm		-40° +100° C	50
TET 10-14	28 x 22 mm	23 mm		-40° +100° C	50
TET 14-20	35 x 25 mm	29 mm		-40° +100° C	50

### THORSMAN TET

Oliebestendige doorvoertules uit chloropreen  
Passe-fils avec résistance à l'huile élevée en chloroprène

IP67





artikel article	Ø x h Ø x p	Ø gat Ø trou	kleur couleur	temperatuur température	
TET 5-7C	21 x 18 mm	16 mm		-25° +95° C	50
TET 7-10C	24 x 20 mm	19 mm		-25° +95° C	50
TET 10-14C	28 x 22 mm	23 mm		-25° +95° C	50
TET 14-20C	35 x 25 mm	29 mm		-25° +95° C	50

### THORSMAN TORIX

Universele lasdop CEBEC uit polyamide  
Connecteur universel CEBEC en polyamide









artikel article	h x b x l h x l x p	sectie section	kleur couleur	
TORIX T6	20 x 14 x 28 mm	0,5 - 12,5 mm <sup>2</sup>		100

- ▲ Installatiemateriaal voor kabelbevestiging
- ▲ Matériel de fixation pour câbles

**THORSMAN TP**

Pluggen  
Chevilles











artikel article	afmeting dimension	kleur couleur	materiaal matériel	temperatuur température	
TP1	Ø 5,5 x 20 mm		HDPE	-50° +80° C	500
TP6x30	Ø 6 x 30 mm		HDPE	-50° +80° C	100
TP2B	Ø 8 x 40 mm		HDPE	-50° +80° C	100
TP3	Ø 10 x 46 mm		HDPE	-50° +80° C	100
TP4	Ø 12 x 60 mm		HDPE	-50° +80° C	100

**THORSMAN CABLE WING**

Kabelklemmen  
Attache-câbles



artikel article	afmeting dimension	type	nagelklem clips avec clou	kleur couleur	materiaal matériel	temperatuur température	
IMT39077	20 x 20 x 130 mm	enkel/simple			polyamide	-20° +60° C	10
IMT39078	20 x 20 x 130 mm	enkel/simple			polyamide	-20° +60° C	25
IMT39079	23 x 20 x 230 mm	dubbel/double			polyamide	-20° +60° C	10
IMT39080	23 x 20 x 230 mm	dubbel/double			polyamide	-20° +60° C	25



▲ Krimpousen  
▲ Gainses thermorétractables



**KK2**

Polyolefin krimpous

Gaine thermorétractable polyolefin

2:1

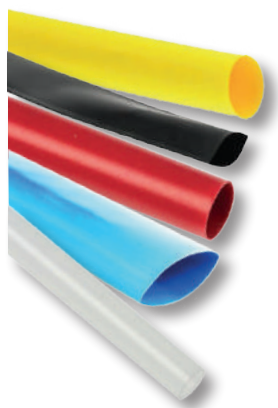

artikel article		kleurcode ** code couleur **	
KK3/64-**	1,2 / 0,6 mm	ZW BR RO OR GE GR BL PA GS WI TR	150 m
KK1/16-**	1,6 / 0,8 mm	ZW BR RO OR GE GR BL PA GS WI TR	150 m
KK3/32-**	2,4 / 1,2 mm	ZW BR RO OR GE GR BL PA GS WI TR	150 m
KK1/8-**	3,2 / 1,6 mm	ZW BR RO OR GE GR BL PA GS WI TR	150 m
KK3/16-**	4,8 / 2,4 mm	ZW BR RO OR GE GR BL PA GS WI TR	75 m
KK1/4-**	6,4 / 3,2 mm	ZW BR RO OR GE GR BL PA GS WI TR	75 m
KK3/8-**	9,5 / 4,8 mm	ZW BR RO OR GE GR BL PA GS WI TR	75 m
KK1/2-**	12,7 / 6,4 mm	ZW BR RO OR GE GR BL PA GS WI TR	50 m
KK5/8-**	16,0 / 8,0 mm	ZW BR RO OR GE GR BL PA GS WI TR	50 m
KK3/4-**	19,1 / 9,6 mm	ZW BR RO OR GE GR BL PA GS WI TR	30 m
KK1-**	25,4 / 12,7 mm	ZW BR RO OR GE GR BL PA GS WI TR	30 m
KK11/4-**	31,8 / 15,9 mm	ZW BR RO OR GE GR BL PA GS WI TR	30 m
KK11/2-**	38,1 / 19,1 mm	ZW BR RO OR GE GR BL PA GS WI TR	30 m
KK2-**	50,8 / 25,4 mm	ZW BR RO OR GE GR BL PA GS WI TR	30 m
KK3-**	76,2 / 38,1 mm	ZW BR RO OR GE GR BL PA GS WI TR	15 m
KK4-**	101,6 / 50,8 mm	ZW BR RO OR GE GR BL PA GS WI TR	15 m
KK5-**	127,0 / 63,5 mm	ZW	15 m
KK6-**	152,4 / 76,2 mm	ZW	15 m

▲ Krimpkousen  
▲ Gainses thermorétractables



**KK3**

Polyolefin krimpous  
Gaine thermorétractable polyolefin

3:1

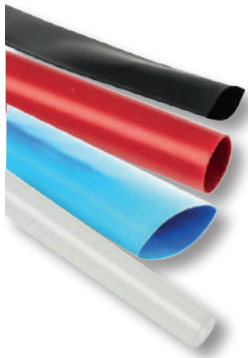

artikel article		kleurcode ** code couleur **	
KK1,5/0,5-**	1,5 / 0,5 mm	ZW RO BL TR	150 m
KK3/1-**	3 / 1 mm	ZW RO BL TR	150 m
KK6/2-**	6 / 2 mm	ZW RO BL TR	75 m
KK9/3-**	9 / 3 mm	ZW RO BL TR	75 m
KK12/4-**	12 / 4 mm	ZW RO BL TR	50 m
KK18/6-**	18 / 6 mm	ZW RO BL TR	30 m
KK24/8-**	24 / 8 mm	ZW RO BL TR	30 m
KK39/13-**	39 / 13 mm	ZW RO BL TR	30 m

**KK3C**

Polyolefin krimpous met lijm  
Gaine thermorétractable polyolefin avec colle

3:1



artikel article		kleurcode ** code couleur **	
KK3/1-**-LIJM	3 / 1 mm	ZW TR	150 m
KK6/2-**-LIJM	6 / 2 mm	ZW TR	150 m
KK9/3-**-LIJM	9 / 3 mm	ZW TR	60 m
KK12/4-**-LIJM	12 / 4 mm	ZW TR	60 m
KK18/6-**-LIJM	18 / 6 mm	ZW TR	60 m
KK24/8-**-LIJM	24 / 8 mm	ZW TR	60 m
KK39/13-**-LIJM	39 / 13 mm	ZW TR	15 m

- ▲ Krimpousen
- ▲ Gainses thermorétractables





### KK3CL

Polyolefin krimpous met lijm (1,22 m)  
Gaine thermorétractable polyolefin avec colle (1,22 m)

3:1





artikel article		kleurcode ** code couleur **	
KK3/1-**-LIJM-L	3 / 1 mm	<input checked="" type="radio"/> ZW <input type="radio"/> TR	25 stuks/pièces
KK6/2-**-LIJM-L	6 / 2 mm	<input checked="" type="radio"/> ZW <input type="radio"/> TR	10 stuks/pièces
KK9/3-**-LIJM-L	9 / 3 mm	<input checked="" type="radio"/> ZW <input type="radio"/> TR	10 stuks/pièces
KK12/4-**-LIJM-L	12 / 4 mm	<input checked="" type="radio"/> ZW <input type="radio"/> TR	10 stuks/pièces
KK18/6-**-LIJM-L	18 / 6 mm	<input checked="" type="radio"/> ZW <input type="radio"/> TR	5 stuks/pièces
KK24/8-**-LIJM-L	24 / 8 mm	<input checked="" type="radio"/> ZW <input type="radio"/> TR	5 stuks/pièces
KK39/13-**-LIJM-L	39 / 13 mm	<input checked="" type="radio"/> ZW <input type="radio"/> TR	1 stuk/pièce

### KK4C

Polyolefin krimpous met lijm  
Gaine thermorétractable polyolefin avec colle

4:1



artikel article		kleurcode ** code couleur **	
KK4/1-**-LIJM	4 / 1 mm	<input checked="" type="radio"/> ZW <input type="radio"/> TR	150 m
KK8/2-**-LIJM	8 / 2 mm	<input checked="" type="radio"/> ZW <input type="radio"/> TR	75 m
KK12/3-**-LIJM	12 / 3 mm	<input checked="" type="radio"/> ZW <input type="radio"/> TR	75 m
KK16/4-**-LIJM	16 / 4 mm	<input checked="" type="radio"/> ZW <input type="radio"/> TR	30 m
KK24/6-**-LIJM	24 / 6 mm	<input checked="" type="radio"/> ZW <input type="radio"/> TR	30 m
KK32/8-**-LIJM	32 / 8 mm	<input checked="" type="radio"/> ZW <input type="radio"/> TR	30 m

▲ Krimpkousen  
▲ Gainses thermorétractables



**KK4CL**

Polyolefin krimpkous met lijm (1,22 m)

Gaine thermorétractable polyolefin avec colle (1,22 m)



artikel article		kleurcode ** code couleur **	
KK4/1-**-LIJM-L	4 / 1 mm		25 stuks/pièces
KK8/2-**-LIJM-L	8 / 2 mm		10 stuks/pièces
KK12/3-**-LIJM-L	12 / 3 mm		10 stuks/pièces
KK16/4-**-LIJM-L	16 / 4 mm		10 stuks/pièces
KK24/6-**-LIJM-L	24 / 6 mm		5 stuks/pièces
KK32/8-**-LIJM-L	32 / 8 mm		5 stuks/pièces
KK52/13-**-LIJM-L	52 / 13 mm		5 stuks/pièces

**CFM**

Middeldikwandige krimpkous met lijm (1,22 m)

Gaine thermorétractable à paroi moyenne avec colle (1,22 m)



artikel article		kleur couleur	
CFM-12/3-ZW-LIJM	12 / 3 mm		10 stuks/pièces
CFM-22/6-ZW-LIJM	22 / 6 mm		10 stuks/pièces
CFM-33/8-ZW-LIJM	33 / 8 mm		10 stuks/pièces
CFM-40/12-ZW-LIJM	40 / 12 mm		10 stuks/pièces
CFM-55/16-ZW-LIJM	55 / 16 mm		10 stuks/pièces
CFM-75/22-ZW-LIJM	75 / 22 mm		10 stuks/pièces
CFM-95/25-ZW-LIJM	95 / 25 mm		5 stuks/pièces
CFM-115/34-ZW-LIJM	115 / 34 mm		5 stuks/pièces
CFM-140/42-ZW-LIJM	140 / 42 mm		5 stuks/pièces
CFM-180/58-ZW-LIJM	180 / 58 mm		5 stuks/pièces



- ▲ Krimpousen
- ▲ Gaines thermorétractables



### RSCGPT

Handige dispenser met polyolefin krimpous  
Distributeur pratique avec gaine thermorétractable polyolefin





artikel article		kleur couleur	
RSCGPT1,5/0,5ZW (10 m)	1,5 / 0,5 mm	●	1
RSCGPT3/1ZW (10 m)	3 / 1 mm	●	1
RSCGPT6/2ZW (7 m)	6 / 2 mm	●	1
RSCGPT9/3ZW (5 m)	9 / 3 mm	●	1
RSCGPT12/4ZW (4 m)	12 / 4 mm	●	1
RSCGGPT18/6ZW (3 m)	18 / 6 mm	●	1
RSCGPT24/8ZW (3 m)	24 / 8 mm	●	1

### RSCGAT

Handige dispenser met polyolefin krimpous met lijm  
Distributeur pratique avec gaine thermorétractable polyolefin avec colle











artikel article		kleur couleur	
RSCGAT3/1ZW (5m)	3 / 1 mm	●	1
RSCGAT6/2ZW (3,5m)	6 / 2 mm	●	1
RSCGAT9/3ZW (3m)	9 / 3 mm	●	1
RSCGAT12/4ZW (2,5m)	12 / 4 mm	●	1
RSCGAT18/6 (2m)	18 / 6 mm	●	1
RSCGAT24/8ZW (1,5m)	24 / 8 mm	●	1

▲ PVC-isolatiekousen  
▲ Gaines isolantes en PVC











**PVC** Zwarte isolatiekous  
Gaine isolante noir



artikel article	∅	wanddikte épaisseur	kleur couleur	
ZW02-05	2 mm	0,5 mm		100 m
ZW03-04	3 mm	0,4 mm		100 m
ZW04-04	4 mm	0,4 mm		100 m
ZW05-04	5 mm	0,4 mm		100 m
ZW06-04	6 mm	0,4 mm		100 m
ZW08-04	8 mm	0,4 mm		100 m
ZW10-04	10 mm	0,4 mm		100 m
ZW12-04	12 mm	0,4 mm		100 m

**PVC** Geel-groene isolatiekous  
Gaine isolante vert-jaune



artikel article	∅	wanddikte épaisseur	kleur couleur	
G.GR02-05	2 mm	0,5 mm		100 m
G.GR03-05	3 mm	0,5 mm		100 m
G.GR04-05	4 mm	0,5 mm		100 m
G.GR05-05	5 mm	0,5 mm		100 m
G.GR06-05	6 mm	0,5 mm		100 m
G.GR08-05	8 mm	0,5 mm		100 m
G.GR10-05	10 mm	0,5 mm		100 m
G.GR12-05	12 mm	0,5 mm		100 m



451



artikel article	omschrijving description	
666451	Krimptang voor geïsoleerde kabelschoenen Pince à sertir pour cosses isolées	1

452



artikel article	omschrijving description	
666452	Krimptang voor niet-geïsoleerde kabelschoenen (6 - 25 mm <sup>2</sup> ) Pince à sertir pour cosses non isolées (6 - 25 mm <sup>2</sup> )	1

453



artikel article	omschrijving description	
666453	Krimptang voor niet-geïsoleerde kabelschoenen (10 - 125 mm <sup>2</sup> ) Pince à sertir pour cosses non isolées (10 - 125 mm <sup>2</sup> )	1

454



artikel article	omschrijving description	
666454	Krimptang 6-kant voor niet-geïsoleerde kabelschoenen (10 - 125 mm <sup>2</sup> ) Pince à sertir hexagonale pour cosses non isolées (10 - 125 mm <sup>2</sup> )	1

456



artikel article	omschrijving description	
666456	Gereedschap voor kunststof bundelbanden tot 4,8 mm Outil de pose pour colliers en plastique jusqu'à 4,8 mm	1



▲ Geïsoleerde kabelschoenen  
▲ Cosses isolées



**RING**

Ring  
Oeillet

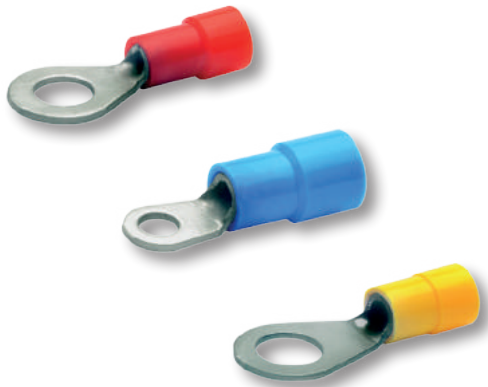

artikel article	mm <sup>2</sup>	kleur couleur	M	
666001	0,5 - 1,5	●	M3	100
666002	0,5 - 1,5	●	M3,5	100
666003	0,5 - 1,5	●	M4	100
666004	0,5 - 1,5	●	M5	100
666005	0,5 - 1,5	●	M6	100
666006	0,5 - 1,5	●	M8	100
666007	0,5 - 1,5	●	M10	100
666008	1,5 - 2,5	●	M3	100
666009	1,5 - 2,5	●	M3,5	100
666010	1,5 - 2,5	●	M4	100
666011	1,5 - 2,5	●	M5	100
666012	1,5 - 2,5	●	M6	100
666013	1,5 - 2,5	●	M8	100
666014	1,5 - 2,5	●	M10	100
666015	4,0 - 6,0	●	M4	100
666016	4,0 - 6,0	●	M5	100
666017	4,0 - 6,0	●	M6	100
666018	4,0 - 6,0	●	M8	100
666019	4,0 - 6,0	●	M10	100
666020	4,0 - 6,0	●	M12	100

**SPADE**

Vork  
Fourche

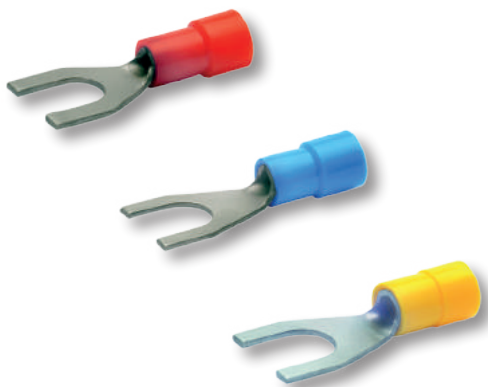



artikel article	mm <sup>2</sup>	kleur couleur	M	
666021	0,5 - 1,5	●	M3	100
666022	0,5 - 1,5	●	M3,5	100
666023	0,5 - 1,5	●	M4	100
666025	0,5 - 1,5	●	M5	100
666026	0,5 - 1,5	●	M6	100
666027	1,5 - 2,5	●	M3,5	100
666028	1,5 - 2,5	●	M4	100
666030	1,5 - 2,5	●	M5	100
666034	1,5 - 2,5	●	M6	100
666035	4,0 - 6,0	●	M3,5	100
666036	4,0 - 6,0	●	M4	100
666037	4,0 - 6,0	●	M5	100
666038	4,0 - 6,0	●	M6	100
666039	4,0 - 6,0	●	M8	100

- ▲ Geïsoleerde kabelschoenen
- ▲ Cosses isolées

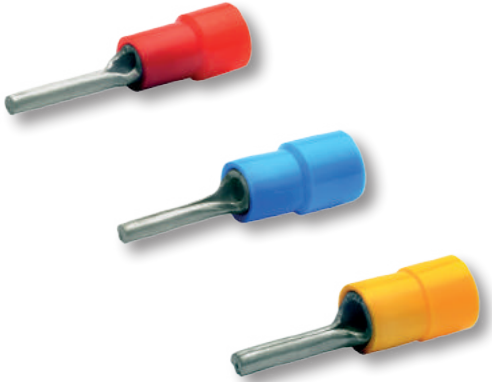

**PIN** Pin  
Embout



artikel article	mm <sup>2</sup>	kleur couleur	L	
666040	0,5 - 1,5	●	7,0 mm	100
666041	0,5 - 1,5	●	9,0 mm	100
666042	0,5 - 1,5	●	10,0 mm	100
666043	0,5 - 1,5	●	12,0 mm	100
666044	1,5 - 2,5	●	7,0 mm	100
666045	1,5 - 2,5	●	9,0 mm	100
666046	1,5 - 2,5	●	12,0 mm	100
666047	1,5 - 2,5	●	17,0 mm	100
666048	4,0 - 6,0	●	14,5 mm	100

**BUTT** Stootverbinder  
Connecteur bout à bout



artikel article	mm <sup>2</sup>	kleur couleur	
666049	0,5 - 1,5	●	100
666050	1,5 - 2,5	●	100
666051	4,0 - 6,0	●	100

**BULLET ♀** Rondstekker vrouwelijk  
Cosse cylindrique femelle



artikel article	mm <sup>2</sup>	kleur couleur	Ø	
666052	0,5 - 1,5	●	4 mm	100
666053	1,5 - 2,5	●	4 mm	100
666054	1,5 - 2,5	●	5 mm	100
666055	4,0 - 6,0	●	5 mm	100

**BULLET ♂** Rondstekker mannelijk  
Cosse cylindrique mâle



artikel article	mm <sup>2</sup>	kleur couleur	Ø	
666056	0,5 - 1,5	●	4 mm	100
666057	1,5 - 2,5	●	4 mm	100
666058	1,5 - 2,5	●	5 mm	100
666059	4,0 - 6,0	●	5 mm	100

▲ Geïsoleerde kabelschoenen  
▲ Cosses isolées



**PIGGYBACK**

Faston mannelijk/vrouwelijk  
Faston mâle/femelle



artikel article	mm <sup>2</sup>	kleur couleur	maat taille	
666060	0,5 - 1,5	●	6,3 x 0,8 mm	100
666061	1,5 - 2,5	●	6,3 x 0,8 mm	100
666062	4,0 - 6,0	●	6,3 x 0,8 mm	100

**FASTON ♀**

Faston vrouwelijk volledig geïsoleerd  
Faston femelle entièrement isolé

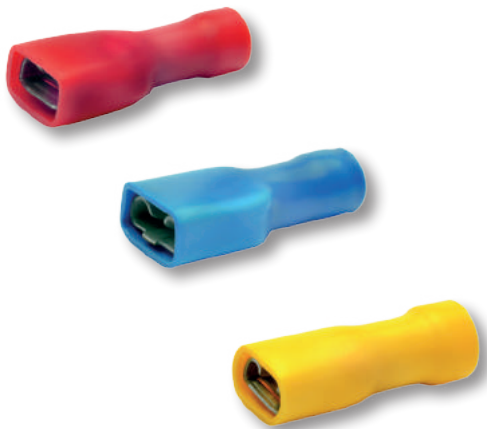

artikel article	mm <sup>2</sup>	kleur couleur	maat taille	
666063	0,5 - 1,5	●	2,8 x 0,5 mm	100
666064	0,5 - 1,5	●	2,8 x 0,8 mm	100
666065	0,5 - 1,5	●	4,8 x 0,5 mm	100
666066	0,5 - 1,5	●	4,8 x 0,8 mm	100
666067	0,5 - 1,5	●	6,3 x 0,8 mm	100
666068	1,5 - 2,5	●	2,8 x 0,5 mm	100
666069	1,5 - 2,5	●	2,8 x 0,8 mm	100
666070	1,5 - 2,5	●	4,8 x 0,5 mm	100
666071	1,5 - 2,5	●	4,8 x 0,8 mm	100
666072	1,5 - 2,5	●	6,3 x 0,8 mm	100
666073	4,0 - 6,0	●	6,3 x 0,8 mm	100

**FASTON ♀**

Faston vrouwelijk  
Faston femelle

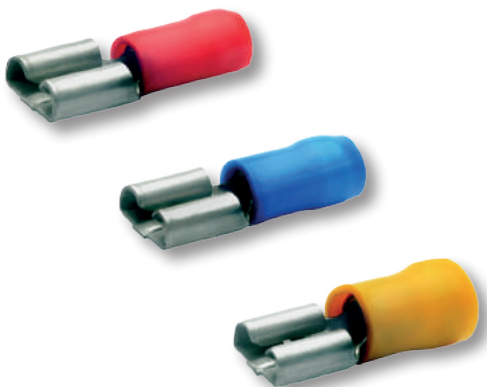

artikel article	mm <sup>2</sup>	kleur couleur	maat taille	
666074	0,5 - 1,5	●	2,8 x 0,5 mm	100
666075	0,5 - 1,5	●	2,8 x 0,8 mm	100
666076	0,5 - 1,5	●	4,8 x 0,5 mm	100
666077	0,5 - 1,5	●	4,8 x 0,8 mm	100
666078	0,5 - 1,5	●	6,3 x 0,8 mm	100
666079	1,5 - 2,5	●	2,8 x 0,5 mm	100
666080	1,5 - 2,5	●	2,8 x 0,8 mm	100
666081	1,5 - 2,5	●	4,8 x 0,5 mm	100
666082	1,5 - 2,5	●	4,8 x 0,8 mm	100
666083	1,5 - 2,5	●	6,3 x 0,8 mm	100
666085	4,0 - 6,0	●	6,3 x 0,8 mm	100

▲ Geïsoleerde kabelschoenen - Soldeerverbinders  
▲ Cosses isolées - Manchons de soudure



**FASTON** ♂

Faston mannelijk  
Faston mâle



artikel article	mm <sup>2</sup>	kleur couleur	maat taille	
666087	0,5 - 1,5	●	2,8 x 0,5 mm	100
666088	0,5 - 1,5	●	2,8 x 0,8 mm	100
666089	0,5 - 1,5	●	4,8 x 0,5 mm	100
666090	0,5 - 1,5	●	4,8 x 0,8 mm	100
666091	0,5 - 1,5	●	6,3 x 0,8 mm	100
666092	1,5 - 2,5	●	2,8 x 0,5 mm	100
666093	1,5 - 2,5	●	2,8 x 0,8 mm	100
666094	1,5 - 2,5	●	4,8 x 0,5 mm	100
666095	1,5 - 2,5	●	4,8 x 0,8 mm	100
666096	1,5 - 2,5	●	6,3 x 0,8 mm	100
666097	4,0 - 6,0	●	6,3 x 0,8 mm	100

**D406**

Stootverbinder met lijm  
Manchon à sertir avec colle



artikel article	maat taille	kleur couleur	
D406-0001	0,5 - 1,0 mm <sup>2</sup>	●	100
D406-0002	1,0 - 2,5 mm <sup>2</sup>	●	100
D406-0003	4,0 - 6,0 mm <sup>2</sup>	●	50

**CWT**

Soldeerverbinder met lijm  
Manchon de soudure avec colle



artikel article	maat taille	kleur couleur	
CWT-9001	0,3 - 0,8 mm <sup>2</sup>	○	100
CWT-9002	0,8 - 2,0 mm <sup>2</sup>	●	100
CWT-9003	2,0 - 4,0 mm <sup>2</sup>	●	100
CWT-9004	4,0 - 6,0 mm <sup>2</sup>	●	50

**SGRS**

Soldeereindverbinder met lijm  
Connecteur d'extrémité à souder avec colle



artikel article	maat taille	kleur couleur	
SGRS-1	0,7 - 2,4 mm <sup>2</sup>	●	50
SGRS-2	2,0 - 4,0 mm <sup>2</sup>	●	50
SGRS-3	3,5 - 8,0 mm <sup>2</sup>	●	50
SGRS-4	7,5 - 12,0 mm <sup>2</sup>	●	25



▲ Niet-geïsoleerde kabelschoenen  
▲ Cosses non isolées



**TUBE TERMINAL**

Buiskabelschoenen  
Cosses tubulaires



artikel article	mm <sup>2</sup>	M		artikel article	mm <sup>2</sup>	M	
666100	10	M4	100	666135	70	M10	50
666101	10	M5	100	666136	70	M12	50
666102	10	M6	100	666137	70	M14	50
666103	10	M8	100	666138	70	M16	50
666104	10	M10	100	666139	70	M20	50
666105	10	M12	100	666140	95	M6	50
666106	16	M5	100	666141	95	M8	50
666107	16	M6	100	666142	95	M10	50
666108	16	M8	100	666143	95	M12	50
666109	16	M10	100	666144	95	M14	50
666110	16	M12	100	666145	95	M16	50
666111	16	M14	100	666146	95	M20	50
666112	25	M5	100	666147	120	M8	30
666113	25	M6	100	666148	120	M10	30
666114	25	M8	100	666149	120	M12	30
666115	25	M10	100	666150	120	M14	30
666116	25	M12	100	666151	120	M16	30
666117	25	M14	100	666152	120	M20	30
666118	35	M5	100	666153	150	M8	10
666119	35	M6	100	666154	150	M10	10
666120	35	M8	100	666155	150	M12	10
666121	35	M10	100	666156	150	M14	10
666122	35	M12	100	666157	150	M16	10
666123	35	M14	100	666158	150	M20	10
666124	35	M16	100	666159	185	M10	6
666125	50	M5	100	666160	185	M12	6
666126	50	M6	100	666161	185	M14	6
666127	50	M8	100	666162	185	M16	6
666128	50	M10	100	666163	185	M20	6
666129	50	M12	100	666164	240	M10	5
666130	50	M14	100	666165	240	M12	5
666131	50	M16	100	666166	240	M14	5
666132	70	M5	50	666167	240	M16	5
666133	70	M6	50	666168	240	M20	5
666134	70	M8	50				

- ▲ Niet-geïsoleerde stootverbinder
- ▲ Connecteur bout à bout non isolé



## BUTT TERMINAL

Niet-geïsoleerde stootverbinders

Connecteurs bout à bout non isolés



artikel article	mm <sup>2</sup>	
666300	10,0	100
666301	16,0	100
666302	25,0	100
666303	35,0	100
666304	50,0	50
666305	70,0	50
666306	95,0	50
666307	120,0	50
666308	150,0	30
666309	185,0	30
666310	240,0	20
666311	300,0	20

▲ Standaard bundelbanden  
▲ Colliers de serrage standard



**52** Standaard bundelbanden  
Colliers de serrage standard

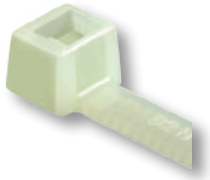

artikel article	afmeting dimension	kleur couleur	temperatuur température	materiaal matière	
5203C	98 x 2,5 mm		-40° +85° C	PA66	100
5206C	160 x 2,6 mm		-40° +85° C	PA66	100
5209C	140 x 3,6 mm		-40° +85° C	PA66	100
5210C	290 x 3,6 mm		-40° +85° C	PA66	100
5214C	200 x 3,6 mm		-40° +85° C	PA66	100
5215C	200 x 4,8 mm		-40° +85° C	PA66	100
5217C	290 x 4,8 mm		-40° +85° C	PA66	100
5219C	360 x 4,8 mm		-40° +85° C	PA66	100
5226C	300 x 7,8 mm		-40° +85° C	PA66	100
5227C	365 x 7,8 mm		-40° +85° C	PA66	100
5231C	540 x 7,8 mm		-40° +85° C	PA66	100
5233C	750 x 7,8 mm		-40° +85° C	PA66	100

**53** Standaard bundelbanden  
Colliers de serrage standard



artikel article	afmeting dimension	kleur couleur	temperatuur température	materiaal matière	
5303C	98 x 2,5 mm		-40° +85° C	PA66	100
5306C	160 x 2,6 mm		-40° +85° C	PA66	100
5309C	140 x 3,6 mm		-40° +85° C	PA66	100
5310C	290 x 3,6 mm		-40° +85° C	PA66	100
5314C	200 x 3,6 mm		-40° +85° C	PA66	100
5315C	200 x 4,8 mm		-40° +85° C	PA66	100
5317C	290 x 4,8 mm		-40° +85° C	PA66	100
5319C	360 x 4,8 mm		-40° +85° C	PA66	100
5326C	300 x 7,8 mm		-40° +85° C	PA66	100
5327C	365 x 7,8 mm		-40° +85° C	PA66	100
5331C	540 x 7,8 mm		-40° +85° C	PA66	100
5333C	750 x 7,8 mm		-40° +85° C	PA66	100











- ▲ Standaard bundelbanden
- ▲ Colliers de serrage standard



**W200**

Standaard bundelbanden  
Colliers de serrage standard



artikel article	afmeting dimension	kleur couleur	temperatuur température	materiaal matière	
W20048BL	200 x 4,8 mm		-40° +85° C	PA66	100
W20048BR	200 x 4,8 mm		-40° +85° C	PA66	100
W20048GR	200 x 4,8 mm		-40° +85° C	PA66	100
W20048OR	200 x 4,8 mm		-40° +85° C	PA66	100
W20048RD	200 x 4,8 mm		-40° +85° C	PA66	100
W20048VI	200 x 4,8 mm		-40° +85° C	PA66	100
W20048YW	200 x 4,8 mm		-40° +85° C	PA66	100
W20048GRY	200 x 4,8 mm		-40° +85° C	PA66	100

- ▲ Kabelbevestiging, -bescherming en -identificatie
- ▲ Matériel de fixation, protection et identification de câblage



## HellermannTyton

### T SERIE

Bundelbanden met binnenvertanding uit polyamide 6.6

Colliers de serrage à crantage intérieur en polyamide 6.6



artikel/article		W	L	Max. Ø	N	
						
111-02809	-	2,3 mm	83 mm	16 mm	80	1000
111-01919	111-01910	2,5 mm	100 mm	22 mm	80	100
111-02319	111-02370	2,5 mm	145 mm	35 mm	80	100
111-02119	111-02110	2,5 mm	205 mm	55 mm	80	100
111-02519	111-02500	2,8 mm	240 mm	65 mm	110	100
111-02619	-	2,8 mm	330 mm	95 mm	110	100
111-03219	111-03210	3,5 mm	150 mm	35 mm	135	100
111-03419	111-03410	3,5 mm	198 mm	50 mm	135	100
111-03549	111-03500	3,5 mm	290 mm	80 mm	135	100
111-03819	-	4 mm	175 mm	40 mm	180	100
111-05819	111-05810	4,6 mm	150 mm	35 mm	225	100
111-05013	111-05000	4,6 mm	200 mm	50 mm	225	100
111-06201	111-06200	4,6 mm	245 mm	65 mm	225	100
111-05219	111-05210	4,6 mm	300 mm	85 mm	225	100
111-05409	111-05400	4,6 mm	390 mm	110 mm	225	100
111-05019	111-08010	4,7 mm	210 mm	55 mm	355	100
111-08229	111-08210	4,7 mm	300 mm	85 mm	355	100
111-05419	111-05410	4,7 mm	390 mm	110 mm	355	100
111-12829	-	7,6 mm	225 mm	55 mm	535	50
111-12219	111-12210	7,6 mm	300 mm	80 mm	535	100
111-14819	111-14810	7,6 mm	365 mm	100 mm	670	100
111-12019	111-12010	7,6 mm	387 mm	100 mm	535	100
111-12619	111-12610	7,6 mm	460 mm	125 mm	535	100
111-12704	111-12701	7,6 mm	600 mm	175 mm	535	50
111-12429	111-12403	7,6 mm	760 mm	225 mm	535	50
111-15419	111-15405	8,8 mm	820 mm	245 mm	780	25
111-15619	111-00124	8,9 mm	530 mm	150 mm	780	25
111-15519	111-15500	8,9 mm	1095 mm	330 mm	780	25
111-15304	111-15300	8,9 mm	1325 mm	405 mm	780	25
111-24705	-	12,5 mm	225 mm	55 mm	1115	100
111-24803	-	12,5 mm	515 mm	125 mm	1115	25
111-25002	111-25001	12,5 mm	563 mm	150 mm	1115	25
111-25219	-	12,5 mm	730 mm	203 mm	1115	25
111-00466	-	12,5 mm	1030 mm	305 mm	1115	25
-	111-24601	12,5 mm	880 mm	254 mm	1115	25

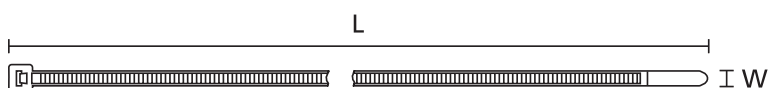

- ▲ Kabelbevestiging, -bescherming en -identificatie
- ▲ Matériel de fixation, protection et identification de câblage

# HellermannTyton

**EVO7** Gereedschap voor kunststof bundelbanden tot 4,8 mm  
Outil de pose pour colliers en plastique jusqu'à 4,8 mm



artikel article	max. bandbreedte largeur max. de collier	max. dikte bundelband épaisseur max. collier	gewicht poids	
110-70129	4,8 mm	1,5 mm	275 g	1

**EVO7SP** Gereedschap voor kunststof bundelbanden tot 4,8 mm  
Outil de pose pour colliers en plastique jusqu'à 4,8 mm

artikel article	max. bandbreedte largeur max. de collier	max. dikte bundelband épaisseur max. collier	gewicht poids	
110-70130	4,8 mm	1,5 mm	275 g	1



**EVO9** Gereedschap voor kunststof bundelbanden tot 13 mm  
Outil de pose pour colliers en plastique jusqu'à 13 mm



artikel article	max. bandbreedte largeur max. de collier	max. dikte bundelband épaisseur max. collier	gewicht poids	
110-80002	13 mm	2 mm	360 g	1

**EVO9SP** Gereedschap voor kunststof bundelbanden tot 13 mm  
Outil de pose pour colliers en plastique jusqu'à 13 mm

artikel article	max. bandbreedte largeur max. de collier	max. dikte bundelband épaisseur max. collier	gewicht poids	
110-80003	13 mm	2 mm	360 g	1



**EVO9HT** Gereedschap voor kunststof bundelbanden tot 13 mm (hoge spankracht)  
Outil de pose pour colliers en plastique jusqu'à 13 mm (haute tension)



artikel article	max. bandbreedte largeur max. de collier	max. dikte bundelband épaisseur max. collier	gewicht poids	
110-80017	13 mm	2 mm	360 g	1



- ▲ Kabelbevestiging, -bescherming en -identificatie
- ▲ Matériel de fixation, protection et identification de câblage

## HellermannTyton

### AUTOTOOL 3080

Afvalvrij bundelsysteem voor diameters tot 80 mm

Frettage automatique sans déchets jusqu'à 80 mm de diamètre



artikel article	omschrijving description	
102-00000	autotool system 3080	1
102-00040	bench mount kit flexible	1
102-00041	horizontal bench mount kit	1
102-00042	bench mount kit for automation	1
102-00043	bench mount kit fixed	1
102-00050	overhead dispenser	1
102-00100	switching power pack	1



102-00100

#### Technische data / Données techniques

<b>elektrische voeding / alimentation électrique</b>	netstroom of powerpack sur secteur ou sur batterie
<b>cyclustijd / temps du cycle</b>	maximum 1,3 s
<b>gewicht / poids</b>	1,7 kg
<b>spankracht / tension de serrage</b>	traploos instelbaar réglable en continu



102-00040



102-00041



102-00042



102-00043

Voor uw montageprocessen bieden wij oplossingen op maat.  
Nous vous proposons des solutions adaptées pour vos processus de montage.

- ▲ Kabelbevestiging, -bescherming en -identificatie
- ▲ Matériel de fixation, protection et identification de câblage



# HellermannTyton

## AUTOTOOL CPK2000

Automatisch bundelen tot 20 mm diameter

Frettage automatique jusqu'à 20 mm de diamètre



106-00100



106-00040



106-00050

artikel article	omschrijving description	
106-00000	autotool CPK 2000	1
106-00050	overhead suspension CPK	1
106-00040	bench mount kit CPK	1
106-00100	power pack CPK	1
106-00110	power pack CPK with control box	1

### Technische data / Données techniques

elektrische voeding / alimentation électrique	netstroom of powerpack sur secteur ou sur batterie
cyclustijd / temps du cycle	0,8 s
gewicht / poids	1,2 kg
spankracht / tension de serrage	traploos instelbaar réglable en continu

Voor uw montageprocessen bieden wij oplossingen op maat.  
Nous vous proposons des solutions adaptées pour vos processus de montage.











- ▲ Kabelbevestiging, -bescherming en -identificatie
- ▲ Matériel de fixation, protection et identification de câblage

## HellermannTyton

### SOFTFIX

Flexibele hersluitbare bundelbanden uit polyurethaan  
Colliers flexibles réouvrables en polyuréthane





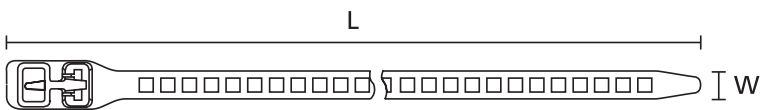

artikel article	W	L	Max. Ø	N	kleur couleur	
115-07189	7 mm	180 mm	45 mm	57		50
115-07269	7 mm	260 mm	79 mm	57		50
115-11269	11 mm	260 mm	55 mm	123		50
115-11349	11 mm	340 mm	90 mm	123		50
115-28589	28 mm	580 mm	150 mm	360		10
115-07190	7 mm	180 mm	45 mm	57		16
115-07270	7 mm	260 mm	79 mm	57		12
115-11270	11 mm	260 mm	55 mm	123		8
115-11350	11 mm	340 mm	90 mm	123		6
115-28590	28 mm	580 mm	150 mm	360		3

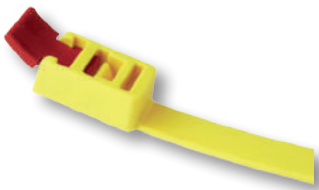

### SPEEDYTIE

Bundelbanden met snelsluiting PA66  
Colliers de serrage réouvrables PA66



artikel article	W	L	Max. Ø	N	kleur couleur	
115-00001	13 mm	752 mm	210 mm	888		5
115-00000	13 mm	752 mm	210 mm	888		25
115-00030	13 mm	752 mm	210 mm	888		5

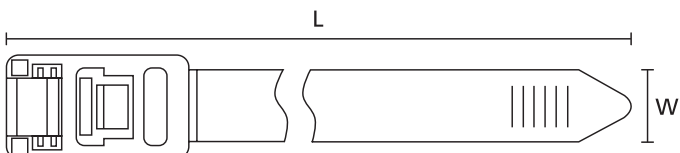









- ▲ Kabelbevestiging, -bescherming en -identificatie
- ▲ Matériel de fixation, protection et identification de câblage

## TEXTIE

Haak-en-lus-kabelbinder  
Colliers textiles, auto-agrippants





artikel article	W	L	Max. Ø	kleur couleur	
130-00012	12,5 mm	150 mm	45 mm		10
130-00018	12,5 mm	200 mm	60 mm		10
130-00016	12,5 mm	200 mm	60 mm		10
130-00017	12,5 mm	200 mm	60 mm		10
130-00014	12,5 mm	200 mm	60 mm		10
130-00021	12,5 mm	200 mm	60 mm		10
130-00013	12,5 mm	200 mm	60 mm		10
130-00019	12,5 mm	330 mm	100 mm		10



## BACK-TO-BACK

Haak-en-lus-band  
Bande textile, auto-agrippante



artikel article	W	L	kleur couleur	
130-00020	12,5 mm	5 m		1
130-00022	13 mm	25 m		1



- ▲ Kabelbevestiging, -bescherming en -identificatie
- ▲ Matériel de fixation, protection et identification de câblage

## HellermannTyton

### MBT304

RVS 304 bundelbanden met kogelsluiting

Colliers en inox 304 avec système de verrouillage à bille



artikel article	W	L	min. Ø	max. Ø	N	
111-93058	4,6 mm	127 mm	12 mm	25 mm	900	100
111-93088	4,6 mm	201 mm	17 mm	50 mm	900	100
111-93148	4,6 mm	362 mm	17 mm	102 mm	900	100
111-93208	4,6 mm	521 mm	17 mm	152 mm	900	100
111-93278	4,6 mm	685 mm	17 mm	203 mm	900	100
111-93338	4,6 mm	838 mm	17 mm	254 mm	900	100
111-94088	7,9 mm	201 mm	17 mm	50 mm	2000	50
111-94148	7,9 mm	362 mm	17 mm	102 mm	2000	50
111-94208	7,9 mm	521 mm	17 mm	152 mm	2000	50
111-94278	7,9 mm	685 mm	17 mm	203 mm	2000	50
111-94338	7,9 mm	838 mm	17 mm	254 mm	2000	50

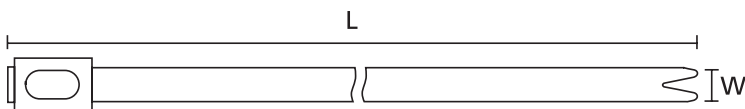

### MBT304XL

RVS 304 bundelbanden met kogelsluiting

Colliers en inox 304 avec système de verrouillage à billes



artikel article	W	L	min. Ø	max. Ø	N	
111-95148	12,3 mm	362 mm	17 mm	102 mm	2700	50
111-95208	12,3 mm	521 mm	17 mm	152 mm	2700	50
111-95278	12,3 mm	681 mm	17 mm	203 mm	2700	50
111-95338	12,3 mm	838 mm	17 mm	254 mm	2700	50

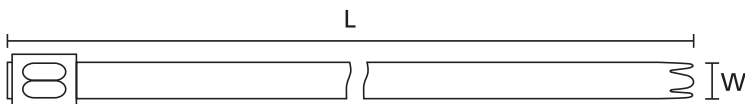

- ▲ Kabelbevestiging, -bescherming en -identificatie
- ▲ Matériel de fixation, protection et identification de câblage

## MBT316

RVS 316 bundelbanden met kogelsluiting

Colliers en inox 316 avec système de verrouillage à bille



artikel article	W	L	min. Ø	max. Ø	N	
111-93059	4,6 mm	127 mm	12 mm	25 mm	900	100
111-93089	4,6 mm	201 mm	12 mm	50 mm	900	100
111-93149	4,6 mm	362 mm	12 mm	102 mm	900	100
111-93209	4,6 mm	521 mm	12 mm	152 mm	900	100
111-93279	4,6 mm	685 mm	12 mm	203 mm	900	100
111-93339	4,6 mm	838 mm	12 mm	254 mm	900	100
111-94089	7,9 mm	201 mm	12 mm	50 mm	2000	50
111-94149	7,9 mm	362 mm	12 mm	102 mm	2000	50
111-94209	7,9 mm	521 mm	12 mm	152 mm	2000	50
111-94279	7,9 mm	685 mm	12 mm	203 mm	2000	50
111-94339	7,9 mm	838 mm	12 mm	254 mm	2000	50

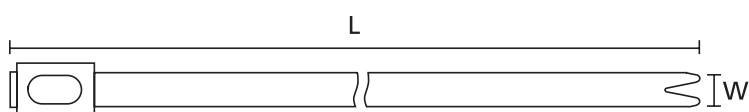

## MBT316XL

RVS 316 bundelbanden met kogelsluiting

Colliers en inox 316 avec système de verrouillage à billes



artikel article	W	L	min. Ø	max. Ø	N	
111-95149	12,3 mm	362 mm	12 mm	102 mm	2700	50
111-95209	12,3 mm	521 mm	12 mm	152 mm	2700	50
111-95279	12,3 mm	681 mm	12 mm	203 mm	2700	50
111-95339	12,3 mm	838 mm	12 mm	254 mm	2700	50
111-01301	16 mm	362 mm	12 mm	102 mm	4100	50
111-01302	16 mm	521 mm	12 mm	152 mm	4100	50
111-01303	16 mm	681 mm	12 mm	203 mm	4100	50
111-01304	16 mm	838 mm	12 mm	254 mm	4100	50
111-01305	16 mm	1092 mm	12 mm	330 mm	4100	50
111-01306	16 mm	1245 mm	12 mm	380 mm	4100	25

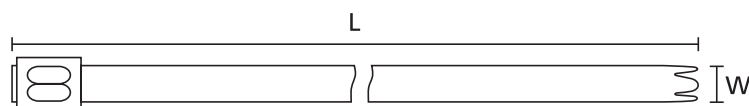

- ▲ Kabelbevestiging, -bescherming en -identificatie
- ▲ Matériel de fixation, protection et identification de câblage

## HellermannTyton

### SSPC316

RVS 316 schroefzadels

Supports en inox 316 à visser

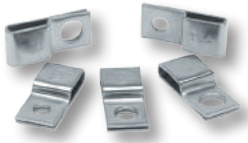

artikel article	W	L	H	FH	G	
151-00837	10,2 mm	23 mm	4,5 mm	4,2 mm	10 mm	100
151-00838	10,2 mm	23 mm	4,5 mm	5,3 mm	10 mm	100
151-00839	10,2 mm	23 mm	4,5 mm	6,3 mm	10 mm	100

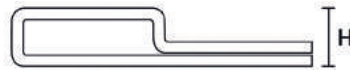
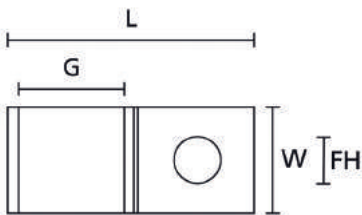

### M-BOSS

RVS 316 markeringen voor extreme toepassingen

Identification en inox 316 pour des applications extrêmes



artikel article	max. bandbreedte largeur max. du collier	tekstregels lignes texte	karacters/regel caractères/ligne	W	L	
544-80101	4,6 mm	1	8	10 mm	45 mm	1000
544-80102	4,6 mm	1	23	10 mm	90 mm	500
544-80201	4,6 mm	3	8	20 mm	45 mm	1000
544-80202	4,6 mm	3	23	20 mm	90 mm	500

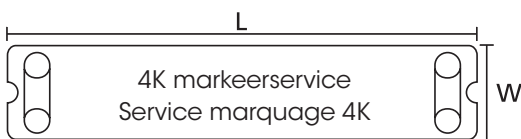

### MK9SST

Gereedschap voor RVS bundelbanden tot 16 mm

Outil de pose pour colliers en inox jusqu'à 16 mm



artikel article	max. bandbreedte largeur max. du collier	max. dikte bundelband épaisseur max. collier	gewicht poids	
110-95000	13 mm	0,2 mm	600 g	1

90 mm

- ▲ Kabelbevestiging, -bescherming en -identificatie
- ▲ Matériel de fixation, protection et identification de câblage

## PSRSC

Spiraalversterkte PVC-beschermingslang (eenvoudig te reinigen)

Gaine de protection en PVC avec spirale renforcée (nettoyage facile)



artikel article	nominale Ø	OD	ID	R	kleur couleur	gewicht poids	
166-40302	16 mm	17,8 mm	12 mm	50°	●	139 g	30 m
166-40303	20 mm	21,1 mm	16 mm	70°	●	174 g	30 m
166-40304	25 mm	26,4 mm	21 mm	90°	●	235 g	30 m
166-40305	32 mm	33,1 mm	26,5 mm	140°	●	327 g	30 m
166-40306	40 mm	41,8 mm	35,4 mm	190°	●	448 g	30 m
166-40307	50 mm	47,9 mm	40 mm	240°	●	725 g	30 m
166-40308	63 mm	59,7 mm	51,3 mm	270°	●	948 g	30 m

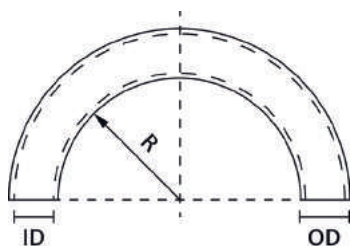

## FMCFFSS

Koppelingen voor spiraalslang PSRSC

Raccords pour gaine PSRSC



artikel article	B	min. Ø	L	A/F3	A/F1	TL	
166-41601	M16	10,7 mm	46 mm	27 mm	29 mm	10 mm	1
166-41602	M20	14,5 mm	49,3 mm	30 mm	32 mm	12 mm	1
166-41603	M25	18,7 mm	53,7 mm	36 mm	38 mm	14 mm	1
166-41604	M32	24,6 mm	53,7 mm	42 mm	45 mm	15 mm	1
166-41605	M40	32,7 mm	58,4 mm	52 mm	55 mm	16 mm	1
166-41606	M50	32,7 mm	63 mm	59 mm	62 mm	16 mm	1

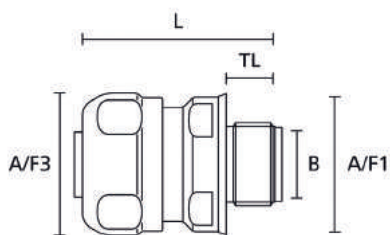

- ▲ Kabelbevestiging, -bescherming en -identificatie
- ▲ Matériel de fixation, protection et identification de câblage

## HellermannTyton

### HELAWRAP

Kabelbeschermslang uit polypropyleen (grijs, wit, zilvergrijs en zwart)

Gaine de protection polypropylène (gris, blanc, gris argenté et noir)



artikel article	max Ø	kleur couleur	
161-64102	9 mm	●	25 m
161-64104	9 mm	○	25 m
161-64103	9 mm	●	25 m
161-64101	9 mm	●	25 m
161-64202	16 mm	●	25 m
161-64207	16 mm	○	25 m
161-64203	16 mm	●	25 m
161-64201	16 mm	●	25 m
161-64302	21 mm	●	25 m
161-64304	21 mm	○	25 m
161-64303	21 mm	●	25 m
161-64301	21 mm	●	25 m
161-64402	27 mm	●	25 m
161-64407	27 mm	○	25 m
161-64403	27 mm	●	25 m
161-64401	27 mm	●	25 m
161-64502	32 mm	●	25 m
161-64504	32 mm	○	25 m
161-64503	32 mm	●	25 m
161-64501	32 mm	●	25 m
161-64205	16 mm	●	2 m
161-64206	16 mm	●	2 m
161-64204	16 mm	●	2 m
161-64405	27 mm	●	2 m
161-64406	27 mm	●	2 m
161-64404	27 mm	●	2 m

- ▲ Kabelbevestiging, -bescherming en -identificatie
- ▲ Matériel de fixation, protection et identification de câblage





# HellermannTyton

## FLEXIFORM

Randbescherming uit polyethyleen voor standaard toepassingen

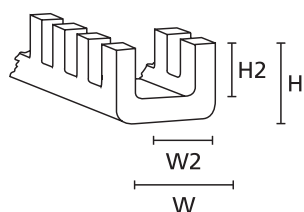
Profil de protection en polyéthylène pour les applications standard



artikel article	plaatdikte épaisseur de la tôle	W	W2	H	H2	kleur couleur	
251-10009	0,40 - 0,90 mm	2,3 mm	0,9 mm	2,7 mm	1,8 mm	○	25 m
251-10109	0,40 - 1,30 mm	3,9 mm	1,5 mm	4,3 mm	2,7 mm	○	25 m
251-10209	1,30 - 2,10 mm	4,6 mm	2,4 mm	4,3 mm	2,7 mm	○	25 m
251-10309	2,10 - 3,30 mm	5,7 mm	3,5 mm	4,3 mm	2,7 mm	○	25 m
251-10409	3,30 - 4,80 mm	8,4 mm	5,1 mm	6,2 mm	4,3 mm	○	25 m
251-10509	4,80 - 6,50 mm	9,9 mm	6,7 mm	6,4 mm	4,5 mm	○	25 m
251-10609	6,50 - 8,10 mm	11,4 mm	8,3 mm	6,8 mm	4,8 mm	○	25 m
251-10709	8,10 - 9,70 mm	13,2 mm	10,1 mm	6,8 mm	4,8 mm	○	25 m
251-10809	9,70 - 12,90 mm	16,4 mm	13,2 mm	6,8 mm	4,8 mm	○	25 m

## EDGE GUARD

Buigbare randbescherming

Protection flexible pour bords de tôle



artikel article	W	W2	H	H2	kleur couleur	
800-00200	1,2 mm	0,6 mm	5 mm	3,15 mm	●	75 m
800-00004	5 mm	1 mm	6,3 mm	4,9 mm	●	75 m
800-00001	6,4 mm	2,4 mm	7,1 mm	5,6 mm	●	75 m

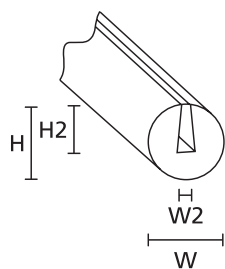

800-00200

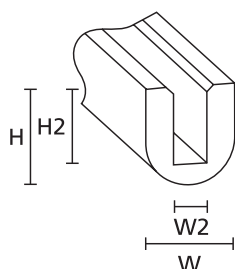

800-00004

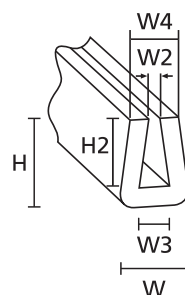

800-00001

- ▲ Kabelbevestiging, -bescherming en -identificatie
- ▲ Matériel de fixation, protection et identification de câblage

## HellermannTyton

### MCT

Detecteerbare bundelbanden voor de levensmiddelen- en farmaceutische industrie

Colliers de serrage détectables pour applications dans les industries agroalimentaire et pharmaceutique



L

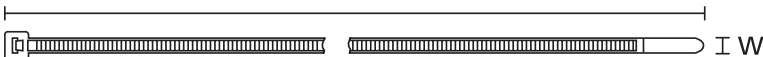

artikel article	W	L	Ø	N	kleur couleur	
111-01225	2,5 mm	100 mm	22 mm	80		100
111-00829	3,5 mm	150 mm	35 mm	135		100
111-00830	4,6 mm	202 mm	50 mm	225		100
111-00831	4,7 mm	380 mm	110 mm	225		100
111-01169	4,7 mm	380 mm	110 mm	225		100
111-01171	4,7 mm	380 mm	110 mm	225		100
111-01167	4,7 mm	380 mm	110 mm	225		100
111-01168	4,7 mm	380 mm	110 mm	225		100
111-01136	7,6 mm	387 mm	100 mm	535		100

### MCTS

Detecteerbare bundelbanden, zeer goed bestand tegen corrosie

Colliers de serrage détectables, très résistants à la corrosion

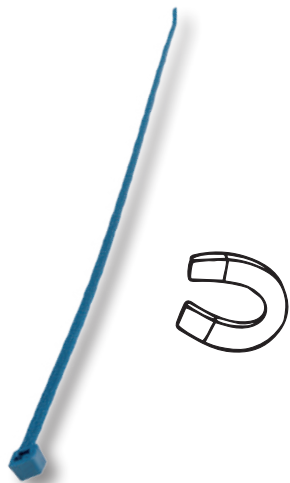

L



artikel article	W	L	Ø	N	kleur couleur	
111-01341	2,5 mm	100 mm	22 mm	60		100
111-01377	2,5 mm	100 mm	22 mm	60		100
111-01380	2,5 mm	100 mm	22 mm	60		100
111-01383	2,5 mm	100 mm	22 mm	60		100
111-01342	3,5 mm	153 mm	36 mm	110		100
111-01378	3,5 mm	153 mm	36 mm	110		100
111-01381	3,5 mm	153 mm	36 mm	110		100
111-01384	3,5 mm	153 mm	36 mm	110		100
111-01343	4,7 mm	203 mm	50 mm	150		100
111-01379	4,7 mm	203 mm	50 mm	150		100
111-01382	4,7 mm	203 mm	50 mm	150		100
111-01385	4,7 mm	203 mm	50 mm	150		100
111-01399	4,8 mm	301 mm	80 mm	150		100
111-01400	4,8 mm	301 mm	80 mm	150		100
111-01401	4,8 mm	301 mm	80 mm	150		100
111-01402	4,8 mm	301 mm	80 mm	150		100



- ▲ Kabelbevestiging, -bescherming en -identificatie
- ▲ Matériel de fixation, protection et identification de câblage









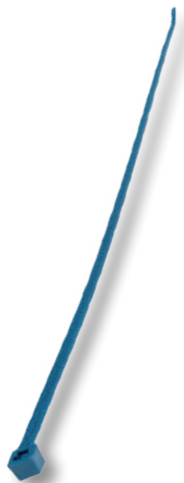

# HellermannTyton

## PPMP

Drijvende bundelbanden uit polypropyleen voor toepassingen met vloeistoffen

Colliers de serrage flottants en polypropylène pour applications avec liquides



artikel article	W	L	Ø	N	kleur couleur	
111-01664	2,5 mm	100 mm	22 mm	85		100
111-01665	3,5 mm	150 mm	35 mm	130		100
111-01666	4,6 mm	200 mm	50 mm	150		100
111-01667	4,6 mm	390 mm	110 mm	150		100
111-01386	4,7 mm	202 mm	50 mm	140		100
111-01668	7,6 mm	387 mm	100 mm	380		100

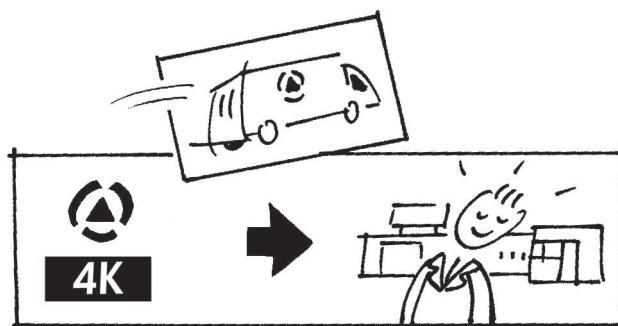
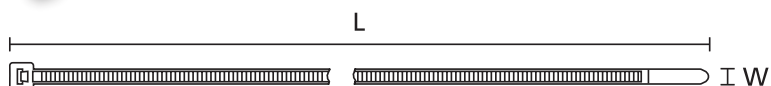

- ▲ Kabelbevestiging, -bescherming en -identificatie
- ▲ Matériel de fixation, protection et identification de câblage

# HellermannTyton

## MCMB

Detecteerbare schroefzadels uit polyamide 6.6  
Supports détectables à visser en polyamide 6.6

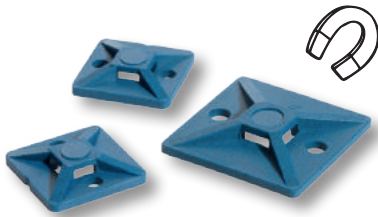

artikel article	W	L	H	FH	G	kleur couleur	
151-01169	19 mm	19 mm	3,8 mm	3,1 mm	3,5 mm		100
151-01170	28 mm	28 mm	4,7 mm	4 mm	4,7 mm		100

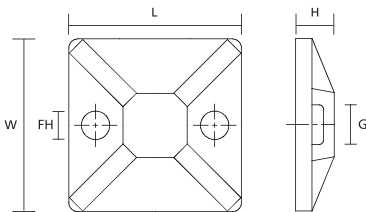

## MCCTAM

Detecteerbare schroefzadels uit polyamide 6.6  
Supports détectables à visser en polyamide 6.6

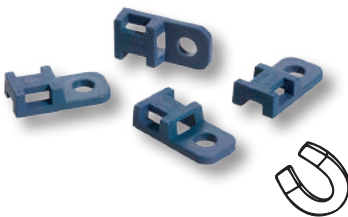

artikel article	W	L	FH	G	kleur couleur	
151-00997	10,3 mm	20,7 mm	4,3 mm	5 mm		100

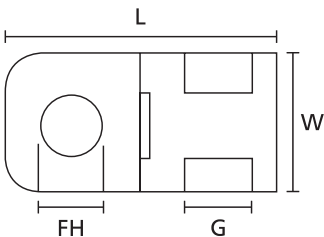

## MCKR

Detecteerbare schroefzadels uit polyamide 6.6  
Supports détectables à visser en polyamide 6.6

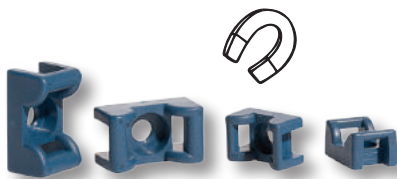

artikel article	W	L	H	FH	G	kleur couleur	
151-00950	11,8 mm	17,8 mm	8,8 mm	4,5 mm	6,4 mm		100
151-01020	14,3 mm	24,8 mm	12 mm	5,2 mm	8,3 mm		100

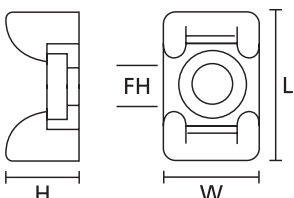



- ▲ Kabelbevestiging, -bescherming en -identificatie
- ▲ Matériel de fixation, protection et identification de câblage

## HellermannTyton

### HWPPMC

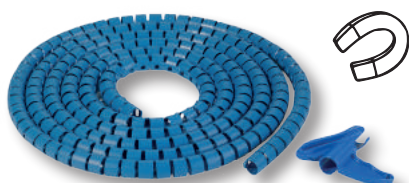
Detecteerbare beschermsslagen uit polypropyleen  
Gainés de protection détectables en polypropylène



artikel article	max. Ø	kleur couleur	tool outil	
161-66000	9 mm	●	HAT 8	25 m
161-66100	16 mm	●	HAT 16	25 m
161-66200	21 mm	●	HAT 20	25 m
161-66300	27 mm	●	HAT 25	25 m
161-66400	32 mm	●	HAT 30	25 m

### HELAWRAP

Handige tool voor HWPPMC  
Outil pratique pour HWPPMC



artikel article	kleur couleur	type	
161-60001	●	HAT 8	10
161-60002	●	HAT 16	10
161-60003	●	HAT 20	10
161-60004	●	HAT 25	10
161-60005	●	HAT 30	10

### SBPEMC

Detecteerbare spiraalslangen uit polyethyleen  
Gainés spiralées détectables en polyéthylène

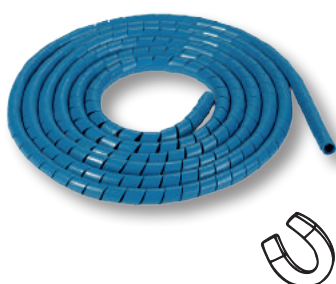

artikel article	min. Ø	max. Ø	kleur couleur	
161-46000	1,6 mm	8 mm	●	30 m
161-46100	5 mm	20 mm	●	30 m
161-46200	10 mm	100 mm	●	30 m
161-46300	20 mm	150 mm	●	30 m

- ▲ Kabelbevestiging, -bescherming en -identificatie
- ▲ Matériel de fixation, protection et identification de câblage

## HellermannTyton

### T-PP

Bundelbanden met verhoogde chemische bestendigheid uit polypropyleen (tot 115° C)

Colliers de serrage à haute résistance chimique en polypropylène (jusqu'à 115° C)



artikel article	W	L	Ø	N	kleur couleur	
111-01922	2,5 mm	100 mm	22 mm	36		1000
111-01917	2,5 mm	100 mm	22 mm	36		100
111-03017	3,6 mm	148 mm	32 mm	89		100
111-04928	4,8 mm	202 mm	44,5 mm	111		100
111-04931	4,8 mm	202 mm	44,5 mm	111		100
111-12827	7,6 mm	225 mm	55 mm	267		500
111-12066	7,6 mm	390 mm	105 mm	267		500

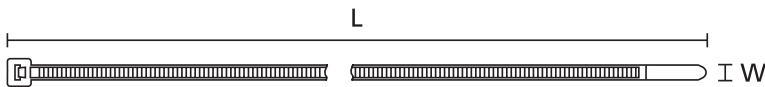

### T-E/FTE

Bundelbanden met verhoogde chemische bestendigheid uit ethyleen-tetrafluorethyleen (tot 170° C)

Colliers de serrage à haute résistance chimique en éthylène-tetrafluorethylène (jusqu'à 170° C)



artikel article	W	L	Ø	N	kleur couleur	
111-00659	2,5 mm	100 mm	22 mm	80		100
111-00698	3,5 mm	150 mm	36 mm	133		100
111-00732	4,7 mm	201 mm	50 mm	222		100
111-00718	4,7 mm	382 mm	105 mm	222		100
111-01125	7,4 mm	387 mm	105 mm	535		50

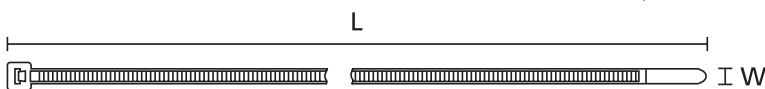

### KR-E/FTE

Schroefzadel met verhoogde chemische bestendigheid uit ethyleen-tetrafluorethyleen (tot 170° C)

Support à visser à haute résistance chimique en éthylène-tetrafluorethylène (jusqu'à 170° C)

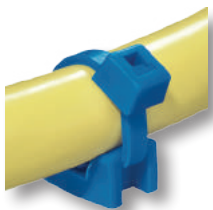

artikel article	W	L	H	FH	G	kleur couleur	
151-00653	11,8 mm	17,8 mm	8,8 mm	4,5 mm	6,4 mm		100
151-00654	14,3 mm	24,8 mm	12,1 mm	6,5 mm	8,3 mm		100

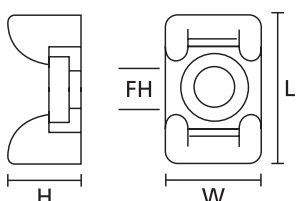



































302

Elektrische isolatietape met flenzen



















Ruban isolant électrique avec des flasques



artikel article	breedte largeur	lengte longueur	dikte épaisseur	kleur couleur	temperatuur température	
1639-302	15 mm	10 m	0,15 mm		-10° C +105° C	20
1642-302	15 mm	10 m	0,15 mm		-10° C +105° C	20
1643-302	15 mm	10 m	0,15 mm		-10° C +105° C	20
1646-302	15 mm	10 m	0,15 mm		-10° C +105° C	20
1647-302	15 mm	10 m	0,15 mm		-10° C +105° C	20
1648-302	15 mm	10 m	0,15 mm		-10° C +105° C	20
1656-302	15 mm	10 m	0,15 mm		-10° C +105° C	20
1660-302	15 mm	10 m	0,15 mm		-10° C +105° C	20
1665-302	15 mm	10 m	0,15 mm		-10° C +105° C	20
1669-302	15 mm	10 m	0,15 mm		-10° C +105° C	20
2051-302	15 mm	10 m	0,15 mm		-10° C +105° C	20
1791-302	15 mm	25 m	0,15 mm		-10° C +105° C	20
1793-302	15 mm	25 m	0,15 mm		-10° C +105° C	20
1795-302	15 mm	25 m	0,15 mm		-10° C +105° C	20
1792-302	15 mm	25 m	0,15 mm		-10° C +105° C	20
1796-302	15 mm	25 m	0,15 mm		-10° C +105° C	20
1798-302	15 mm	25 m	0,15 mm		-10° C +105° C	20
1801-302	15 mm	25 m	0,15 mm		-10° C +105° C	20
1803-302	15 mm	25 m	0,15 mm		-10° C +105° C	20
1805-302	15 mm	25 m	0,15 mm		-10° C +105° C	20
1806-302	15 mm	25 m	0,15 mm		-10° C +105° C	20
2067-302	15 mm	25 m	0,15 mm		-10° C +105° C	20
1813-302	19 mm	25 m	0,15 mm		-10° C +105° C	16
1812-302	19 mm	25 m	0,15 mm		-10° C +105° C	16
1814-302	19 mm	25 m	0,15 mm		-10° C +105° C	16
1817-302	19 mm	25 m	0,15 mm		-10° C +105° C	16
1820-302	19 mm	25 m	0,15 mm		-10° C +105° C	16
1822-302	19 mm	25 m	0,15 mm		-10° C +105° C	16
1825-302	19 mm	25 m	0,15 mm		-10° C +105° C	16
1828-302	19 mm	25 m	0,15 mm		-10° C +105° C	16
1832-302	19 mm	25 m	0,15 mm		-10° C +105° C	16
1836-302	19 mm	25 m	0,15 mm		-10° C +105° C	16
2068-302	19 mm	25 m	0,15 mm		-10° C +105° C	16
2071-302	50 mm	25 m	0,15 mm		-10° C +105° C	12

**352** PVC isolatietape met flenzen  
Ruban isolant PVC avec flasques



artikel article	breedte largeur	lengte longueur	dikte épaisseur	kleur couleur	temperatuur température	
2173-352	50 mm	10 m	0,15 mm		-10° C +105° C	12
2178-352	50 mm	10 m	0,15 mm		-10° C +105° C	12
2181-352	50 mm	10 m	0,15 mm		-10° C +105° C	12
2184-352	50 mm	10 m	0,15 mm		-10° C +105° C	12
2195-352	50 mm	10 m	0,15 mm		-10° C +105° C	12
2200-352	50 mm	10 m	0,15 mm		-10° C +105° C	12
2206-352	50 mm	10 m	0,15 mm		-10° C +105° C	12
2211-352	50 mm	10 m	0,15 mm		-10° C +105° C	12
2217-352	50 mm	10 m	0,15 mm		-10° C +105° C	12
2329-352	50 mm	25 m	0,15 mm		-10° C +105° C	12
2333-352	50 mm	25 m	0,15 mm		-10° C +105° C	12
2337-352	50 mm	25 m	0,15 mm		-10° C +105° C	12
2339-352	50 mm	25 m	0,15 mm		-10° C +105° C	12
2344-352	50 mm	25 m	0,15 mm		-10° C +105° C	12
2348-352	50 mm	25 m	0,15 mm		-10° C +105° C	12
2354-352	50 mm	25 m	0,15 mm		-10° C +105° C	12
2357-352	50 mm	25 m	0,15 mm		-10° C +105° C	12
2359-352	50 mm	25 m	0,15 mm		-10° C +105° C	12

**8200** Duct tape  
Ruban duct tape

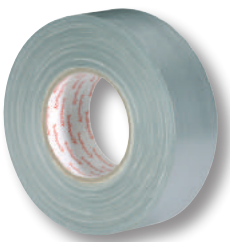



















artikel article	breedte largeur	lengte longueur	dikte épaisseur	kleur couleur	temperatuur température	
48676-8200	50 mm	50 m	0,3 mm		-20° C/+80° C	24
52464-8200	50 mm	50 m	0,3 mm		-20° C/+80° C	24

**352/0**

PVC isolatietape  
Ruban isolant PVC



artikel article	breedte largeur	lengte longueur	dikte épaisseur	kleur couleur	temperatuur température	
2332-3520	50 mm	25 m	0,15 mm		-10° C +105° C	14
2334-3520	50 mm	25 m	0,15 mm		-10° C +105° C	14
2338-3520	50 mm	25 m	0,15 mm		-10° C +105° C	14
2340-3520	50 mm	25 m	0,15 mm		-10° C +105° C	14
2345-3520	50 mm	25 m	0,15 mm		-10° C +105° C	14
2349-3520	50 mm	25 m	0,15 mm		-10° C +105° C	14
2353-3520	50 mm	25 m	0,15 mm		-10° C +105° C	14
2358-3520	50 mm	25 m	0,15 mm		-10° C +105° C	14
2360-3520	50 mm	25 m	0,15 mm		-10° C +105° C	14
2373-3520	100 mm	25 m	0,15 mm		-10° C +105° C	6
5325-3520	100 mm	25 m	0,15 mm		-10° C +105° C	6
2379-3520	100 mm	25 m	0,15 mm		-10° C +105° C	6
2382-3520	100 mm	25 m	0,15 mm		-10° C +105° C	6
31901-3520	100 mm	25 m	0,15 mm		-10° C +105° C	6
36219-3520	100 mm	25 m	0,15 mm		-10° C +105° C	6
36218-3520	100 mm	25 m	0,15 mm		-10° C +105° C	6
5326-3520	100 mm	25 m	0,15 mm		-10° C +105° C	6
2392-3520	100 mm	25 m	0,15 mm		-10° C +105° C	6

**913**

PET-foil zelfklevende tape  
Ruban adhésif PET-foil

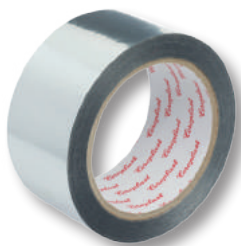

artikel article	breedte largeur	lengte longueur	dikte épaisseur	kleur couleur	temperatuur température	
158831-913	50 mm	100 m	0,05 mm		-40° C/+80° C	32

Deze is scheurvast en wordt o.a. gebruikt voor de verbinding van 2 folies.  
Il est résistant à la déchirure et est, entre autres choses, utilisé pour la connexion de 2 films.

**942**

Aluminium zelfklevende tape (40 micron)  
Ruban adhésif aluminium (40 microns)

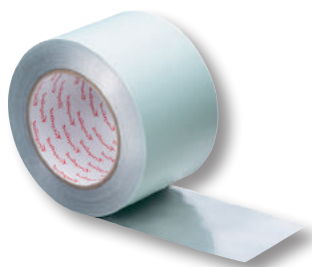

artikel article	breedte largeur	lengte longueur	dikte épaisseur	kleur couleur	temperatuur température	
2897-942	50 mm	50 m	0,08 mm		-40° C/+80° C	24
2896-942	75 mm	50 m	0,08 mm		-40° C/+80° C	18
2898-942	100 mm	50 m	0,08 mm		-40° C/+80° C	12









## GARBY COLLECTION

**Fontini**  
BY *Font*  
BARCELONA

**306** Porseleinen enkelpolige schakelaars 10 A / 250 V  
Interrupteurs unipolaires en porcelaine 10 A / 250 V









artikel article	omschrijving description	kleur couleur	
30.306.17.2	met porseleinen vlinderknop avec noeud papillon en porcelaine		1
30.306.27.2	met porseleinen vlinderknop avec noeud papillon en porcelaine		1
30.306.30.2	met porseleinen retrodraaiknop avec bouton papillon rétro en porcelaine		1
30.306.28.2	met porseleinen retrodraaiknop avec bouton papillon rétro en porcelaine		1
30.306.21.2	met houten vlinderknop avec noeud papillon en bois		1
30.306.29.2	met houten vlinderknop avec noeud papillon en bois		1



**314** Porseleinen dubbelpolige schakelaars 10 A / 250 V  
Interrupteurs bipolaires en porcelaine 10 A / 250 V



artikel article	omschrijving description	kleur couleur	
30.314.17.2	met porseleinen vlinderknop avec noeud papillon en porcelaine		1
30.314.27.2	met porseleinen vlinderknop avec noeud papillon en porcelaine		1
30.314.30.2	met porseleinen retrodraaiknop avec bouton papillon rétro en porcelaine		1
30.314.28.2	met porseleinen retrodraaiknop avec bouton papillon rétro en porcelaine		1
30.314.21.2	met houten vlinderknop avec noeud papillon en bois		1
30.314.29.2	met houten vlinderknop avec noeud papillon en bois		1





**GARBY COLLECTION**

**Fontini**  
 BY *Font*  
 BARCELONA

**304** Porseleinen kruisschakelaars 10 A / 250 V  
 Permutateurs en porcelaine 10 A / 250 V



artikel article	omschrijving description	kleur couleur	
30.304.17.2	met porseleinen vlinderknop avec noeud papillon en porcelaine	○	1
30.304.27.2	met porseleinen vlinderknop avec noeud papillon en porcelaine	●	1
30.304.30.2	met porseleinen retrodraaiknop avec bouton papillon rétro en porcelaine	○	1
30.304.28.2	met porseleinen retrodraaiknop avec bouton papillon rétro en porcelaine	●	1
30.304.21.2	met houten vlinderknop avec noeud papillon en bois	○	1
30.304.29.2	met houten vlinderknop avec noeud papillon en bois	●	1



**308** Porseleinen wisselschakelaars 10 A / 250 V  
 Commutateurs en porcelaine 10 A / 250 V



artikel article	omschrijving description	kleur couleur	
30.308.17.2	met porseleinen vlinderknop avec noeud papillon en porcelaine	○	1
30.308.27.2	met porseleinen vlinderknop avec noeud papillon en porcelaine	●	1
30.308.30.2	met porseleinen retrodraaiknop avec bouton papillon rétro en porcelaine	○	1
30.308.28.2	met porseleinen retrodraaiknop avec bouton papillon rétro en porcelaine	●	1
30.308.21.2	met houten vlinderknop avec noeud papillon en bois	○	1
30.308.29.2	met houten vlinderknop avec noeud papillon en bois	●	1



## GARBY COLLECTION

**Fontini**  
BY *Font*  
BARCELONA

**208** Porseleinen stopcontacten 16 A / 250 V met kinderbeveiliging  
Prises en porcelaine 16 A / 250 V avec éclipses de protection



artikel article	omschrijving description	kleur couleur	
30.208.17.2	met kunststof inzetstuk avec insert plastique		1
30.208.27.2	met kunststof inzetstuk avec insert plastique		1

**211** Porseleinen stopcontacten 16 A / 250 V met kinderbeveiliging  
Prises en porcelaine 16 A / 250 V avec éclipses de protection



artikel article	omschrijving description	kleur couleur	
30.211.17.2	volledig porselein tout porcelaine		1
30.211.27.2	volledig porselein tout porcelaine		1

**FRAME** Adapter  
Adaptateur



artikel article	omschrijving description	
20.901.97.2	voor inbouwdoos zonder vijzen pour boîtier sans vis	1

**SPRAY** Verfspuitbus  
Spray



artikel article	omschrijving description	
30.001.22.2	verouderd metaal 200 ml métal vieilli 200 ml	1

- ▲ Porseleinen schakelaars & designschakelaars
- ▲ Gamme d'interrupteurs porcelaine & design



## GARBY COLLECTION

**Fontini**  
BY *Font*  
BARCELONA

### ADAPTOR

Adapter  
Adaptateur



artikel article	omschrijving description	
30.007.03.2	om buis Ø 20 mm in houten afdekplaat te monteren pour installer tube Ø 20 mm sur socle en bois	1

### BOX

Aftakdoos  
Boîte de dérivation



artikel article	omschrijving description	
30.401.22.2	verouderd metaal Ø 116 mm voor buis Ø 16, 20 of 25 mm métal vieilli Ø 116mm pour tube Ø 16, 20 ou 25 mm	1

### CLAMP

Afstandsklemmen  
Attaches longues



artikel article	omschrijving description	
30.816.03.2	Ø 16 mm, verouderd metaal / métal vieilli	25
30.820.03.2	Ø 20 mm, verouderd metaal / métal vieilli	25
30.825.03.2	Ø 25 mm, verouderd metaal / métal vieilli	25

### CLIP

Klemmen  
Attaches



artikel article	omschrijving description	
30.716.03.2	Ø 16 mm, verouderd metaal / métal vieilli	25
30.720.03.2	Ø 20 mm, verouderd metaal / métal vieilli	25
30.725.03.2	Ø 25 mm, verouderd metaal / métal vieilli	25

- ▲ Porseleinen schakelaars & designschakelaars
- ▲ Gamme d'interrupteurs porcelaine & design

## GARBY COLLECTION

**Fontini**  
BY *Font*  
BARCELONA

### TUBE

Metalen buizen  
Tubes en métal



artikel article	omschrijving description	
30.016.22.2	Ø 16 mm, verouderd metaal / métal vieilli	4 x 3 m
30.020.22.2	Ø 20 mm, verouderd metaal / métal vieilli	4 x 3 m
30.025.22.2	Ø 25 mm, verouderd metaal / métal vieilli	4 x 3 m

### ELBOW

Inspectiebochten  
Coudes d'inspection



artikel article	omschrijving description	
30.116.22.2	Ø 16 mm, verouderd metaal / métal vieilli	1
30.120.22.2	Ø 20 mm, verouderd metaal / métal vieilli	1
30.125.22.2	Ø 25 mm, verouderd metaal / métal vieilli	1

### COUPLING

Moffen  
Manchons



artikel article	omschrijving description	
30.516.22.2	Ø 16 mm, verouderd metaal / métal vieilli	10
30.520.22.2	Ø 20 mm, verouderd metaal / métal vieilli	10
30.525.22.2	Ø 25 mm, verouderd metaal / métal vieilli	5

### TEE

Inspectie T-stukken  
Tés d'inspection



artikel article	omschrijving description	
30.616.22.2	Ø 16 mm, verouderd metaal / métal vieilli	1
30.620.22.2	Ø 20 mm, verouderd metaal / métal vieilli	1
30.625.22.2	Ø 25 mm, verouderd metaal / métal vieilli	1

- ▲ Porseleinen schakelaars & designschakelaars
- ▲ Gamme d'interrupteurs porcelaine & design



## GARBY COLLECTION

**Fontini**  
BY *Font*  
BARCELONA

### BASE Afdekplaten Plaques



artikel article	omschrijving description	
30.801.00.2	1 module blank hout / bois naturel	1
30.801.21.2	1 module verouderd hout / bois vieilli	1



30.802.00.2	2 modules blank hout / bois naturel	1
30.802.21.2	2 modules verouderd hout / bois vieilli	1



30.803.00.2	3 modules blank hout / bois naturel	1
30.803.21.2	3 modules verouderd hout / bois vieilli	1

### BASE Afdekplaten met ingang Plaques avec entrée



artikel article	omschrijving description	
30.821.00.2	1 module blank hout / bois naturel	1
30.821.21.2	1 module verouderd hout / bois vieilli	1



30.822.00.2	2 modules blank hout / bois naturel	1
30.822.21.2	2 modules verouderd hout / bois vieilli	1



30.823.00.2	3 modules blank hout / bois naturel	1
30.823.21.2	3 modules verouderd hout / bois vieilli	1



- ▲ Porseleinen schakelaars & designschakelaars
- ▲ Gamme d'interrupteurs porcelaine & design

## GARBY COLLECTION

**Fontini**  
BY *Font*  
BARCELONA

**BASE** Horizontale afdekplaten met ingang  
Plaques horizontales avec entrée



artikel article	omschrijving description	
30.832.00.2	2 modules blank hout / bois naturel	1
30.832.21.2	2 modules verouderd hout / bois vieilli	1



30.833.00.2	3 modules blank hout / bois naturel	1
30.833.21.2	3 modules verouderd hout / bois vieilli	1







## GARBY COLONIAL COLLECTION

**Fontini**  
 BY *Font*  
 BARCELONA

**306**

Porseleinen enkelpolige schakelaars 10 A / 250 V  
 Interrupteurs unipolaires en porcelaine 10 A / 250 V



artikel article	omschrijving description	kleur couleur	
31.306.17.2	met porseleinen vlinderknop avec noeud papillon en porcelaine	○	1
31.306.27.2	met porseleinen vlinderknop avec noeud papillon en porcelaine	●	1
31.306.23.2	met porseleinen retrodraaiknop avec bouton papillon rétro en porcelaine	○	1
31.306.28.2	met porseleinen retrodraaiknop avec bouton papillon rétro en porcelaine	●	1
31.306.21.2	met houten vlinderknop avec noeud papillon en bois	○	1
31.306.29.2	met houten vlinderknop avec noeud papillon en bois	●	1

**314**

Porseleinen dubbelpolige schakelaars 10 A / 250 V  
 Interrupteurs bipolaires en porcelaine 10 A / 250 V









artikel article	omschrijving description	kleur couleur	
31.314.17.2	met porseleinen vlinderknop avec noeud papillon en porcelaine	○	1
31.314.27.2	met porseleinen vlinderknop avec noeud papillon en porcelaine	●	1
31.314.23.2	met porseleinen retrodraaiknop avec bouton papillon rétro en porcelaine	○	1
31.314.28.2	met porseleinen retrodraaiknop avec bouton papillon rétro en porcelaine	●	1
31.314.21.2	met houten vlinderknop avec noeud papillon en bois	○	1
31.314.29.2	met houten vlinderknop avec noeud papillon en bois	●	1

## GARBY COLONIAL COLLECTION

**Fontini**  
BY *Font*  
BARCELONA







**304** Porseleinen kruisschakelaars 10 A / 250 V  
Permutateurs en porcelaine 10 A / 250 V



artikel article	omschrijving description	kleur couleur	
31.304.17.2	met porseleinen vlinderknop avec noeud papillon en porcelaine		1
31.304.27.2	met porseleinen vlinderknop avec noeud papillon en porcelaine		1
31.304.23.2	met porseleinen retrodraaiknop avec bouton papillon rétro en porcelaine		1
31.304.28.2	met porseleinen retrodraaiknop avec bouton papillon rétro en porcelaine		1
31.304.21.2	met houten vlinderknop avec noeud papillon en bois		1
31.304.29.2	met houten vlinderknop avec noeud papillon en bois		1

**308** Porseleinen wisselschakelaars 10 A / 250 V  
Commutateurs en porcelaine 10 A / 250 V



artikel article	omschrijving description	kleur couleur	
31.308.17.2	met porseleinen vlinderknop avec noeud papillon en porcelaine		1
31.308.27.2	met porseleinen vlinderknop avec noeud papillon en porcelaine		1
31.308.23.2	met porseleinen retrodraaiknop avec bouton papillon rétro en porcelaine		1
31.308.28.2	met porseleinen retrodraaiknop avec bouton papillon rétro en porcelaine		1
31.308.21.2	met houten vlinderknop avec noeud papillon en bois		1
31.308.29.2	met houten vlinderknop avec noeud papillon en bois		1



## GARBY COLONIAL COLLECTION

**Fontini**  
 BY *Font*  
 BARCELONA

**300** Porseleinen dubbele enkelpolige schakelaars 10 A / 250 V  
 Double interrupteur unipolaires en porcelaine 10 A / 250 V



artikel article	omschrijving description	kleur couleur	
31.300.17.2	met porseleinen vlinderknop avec noeud papillon en porcelaine	○	1
31.300.27.2	met porseleinen vlinderknop avec noeud papillon en porcelaine	●	1
31.300.23.2	met porseleinen retrodraaiknop avec bouton papillon rétro en porcelaine	○	1
31.300.28.2	met porseleinen retrodraaiknop avec bouton papillon rétro en porcelaine	●	1
31.300.21.2	met houten vlinderknop avec noeud papillon en bois	○	1
31.300.29.2	met houten vlinderknop avec noeud papillon en bois	●	1

**302** Porseleinen dubbele wisselschakelaars 10 A / 250 V  
 Double va-et-vient en porcelaine 10 A / 250 V



artikel article	omschrijving description	kleur couleur	
31.302.17.2	met porseleinen vlinderknop avec noeud papillon en porcelaine	○	1
31.302.27.2	met porseleinen vlinderknop avec noeud papillon en porcelaine	●	1
31.302.23.2	met porseleinen retrodraaiknop avec bouton papillon rétro en porcelaine	○	1
31.302.28.2	met porseleinen retrodraaiknop avec bouton papillon rétro en porcelaine	●	1
31.302.21.2	met houten vlinderknop avec noeud papillon en bois	○	1
31.302.29.2	met houten vlinderknop avec noeud papillon en bois	●	1

## GARBY COLONIAL COLLECTION

**Fontini**  
BY *Font*  
BARCELONA

**208** Kunststof stopcontacten 16 A / 250 V met kinderbeveiliging  
Prises en plastique 16 A / 250 V avec éclipses de protection



artikel article	kleur couleur	
31.208.05.2		1
31.208.02.2		1

**208** Porseleinen stopcontacten 16 A / 250 V met kinderbeveiliging  
Prises en porcelaine 16 A / 250 V



artikel article	omschrijving description	kleur couleur	
31.208.17.2	volledig porselein tout porcelaine		1
31.208.27.2	volledig porselein tout porcelaine		1

**BASE** Afdekplaten  
Plaques



artikel article	omschrijving description	kleur couleur	
31.801.00.2	1 module blank hout / bois naturel		1
31.801.17.2	1 module wit porselein / porcelaine blanche		1
31.801.21.2	1 module verouderd hout / bois vieilli		1
31.801.27.2	1 module zwart porselein / porcelaine noire		1

- ▲ Porseleinen schakelaars & designschakelaars
- ▲ Gamme d'interrupteurs porcelaine & design







## GARBY COLONIAL COLLECTION

**Fontini**  
BY *Font*  
BARCELONA





**BASE** Afdekplaten  
Plaques



artikel article	omschrijving description	kleur couleur	
31.802.00.2	2 modules blank hout / bois naturel		1
31.802.17.2	2 modules wit porselein / porcelaine blanche		1
31.802.21.2	2 modules verouderd hout / bois vieilli		1
31.802.27.2	2 modules zwart porselein / porcelaine noire		1

**BASE** Afdekplaten  
Plaques



artikel article	omschrijving description	kleur couleur	
31.803.00.2	3 modules blank hout / bois naturel		1
31.803.17.2	3 modules wit porselein / porcelaine blanche		1
31.803.21.2	3 modules verouderd hout / bois vieilli		1
31.803.27.2	3 modules zwart porselein / porcelaine noire		1

## DIMBLER COLLECTION

**Fontini**  
BY *Font*  
BARCELONA

**306** Porseleinen enkelpolige schakelaars 10 A / 250 V  
Interrupteurs unipolaires en porcelaine 10 A / 250 V



artikel article	omschrijving description	
60.306.64.2	wit met tuimelschakelaar chroom blanc avec manette chromée	1
60.306.65.2	wit met tuimelschakelaar brons blanc avec manette bronze	1



60.306.56.2	wit + vernikkeld met tuimelschakelaar chroom blanc et laiton nickelé satiné avec manette chromée	1
60.306.57.2	wit + brons met tuimelschakelaar brons blanc + laiton bronze avec manette bronze	1



60.306.44.2	wit met tuimelschakelaar chroom en draadingang blanc avec manette chromée et passage de fil	1
60.306.45.2	wit met tuimelschakelaar brons en draadingang blanc avec manette bronze et passage de fil	1



60.306.51.2	wit + vernikkeld met tuimelschakelaar chroom en draadingang blanc et laiton nickelé satiné avec manette chromée et passage de fil	1
60.306.53.2	wit + brons met tuimelschakelaar brons en draadingang blanc + laiton bronze avec manette bronze et passage de fil	1





## DIMBLER COLLECTION

**Fontini**  
 BY *Font*  
 BARCELONA

**314** Porseleinen dubbelpolige schakelaars 10 A / 250 V  
 Interrupteurs bipolaires en porcelaine 10 A / 250 V



artikel article	omschrijving description	
60.314.64.2	wit met tuimelschakelaar chroom blanc avec manette chromée	1
60.314.65.2	wit met tuimelschakelaar brons blanc avec manette bronze	1



60.314.56.2	wit + vernikkeld met tuimelschakelaar chroom blanc et laiton nickelé satiné avec manette chromée	1
60.314.57.2	wit + brons met tuimelschakelaar brons blanc + laiton bronze avec manette bronze	1



60.314.44.2	wit met tuimelschakelaar chroom en draadingang blanc avec manette chromée et passage de fil	1
60.314.45.2	wit met tuimelschakelaar brons en draadingang blanc avec manette bronze et passage de fil	1



60.314.51.2	wit + vernikkeld met tuimelschakelaar chroom en draadingang blanc et laiton nickelé satiné avec manette chromée et passage de fil	1
60.314.53.2	wit + brons met tuimelschakelaar brons en draadingang blanc + laiton bronze avec manette bronze et passage de fil	1



## DIMBLER COLLECTION

**Fontini**  
BY *Font*  
BARCELONA

**304** Porseleinen kruisschakelaars 10 A / 250 V  
Permutateurs en porcelaine 10 A / 250 V

artikel article	omschrijving description	
60.304.64.2	wit met tuimelschakelaar chroom blanc avec manette chromée	1
60.304.65.2	wit met tuimelschakelaar brons blanc avec manette bronze	1
60.304.56.2	wit + vernikkeld met tuimelschakelaar chroom blanc et laiton nickelé satiné avec manette chromée	1
60.304.57.2	wit + brons met tuimelschakelaar brons blanc + laiton bronze avec manette bronze	1
60.304.44.2	wit met tuimelschakelaar chroom en draadingang blanc avec manette chromée et passage de fil	1
60.304.45.2	wit met tuimelschakelaar brons en draadingang blanc avec manette bronze et passage de fil	1
60.304.51.2	wit + vernikkeld met tuimelschakelaar chroom en draadingang blanc et laiton nickelé satiné avec manette chromée et passage de fil	1
60.304.53.2	wit + brons met tuimelschakelaar brons en draadingang blanc + laiton bronze avec manette bronze et passage de fil	1

- ▲ Porseleinen schakelaars & designschakelaars
- ▲ Gamme d'interrupteurs porcelaine & design



## DIMBLER COLLECTION

**Fontini**  
BY *Font*  
BARCELONA

**308**

Porseleinen wisselschakelaars 10 A / 250 V  
Commutateurs en porcelaine 10 A / 250 V



artikel article	omschrijving description	
60.308.64.2	wit met tuimelschakelaar chroom blanc avec manette chromée	1
60.308.65.2	wit met tuimelschakelaar brons blanc avec manette bronze	1



60.308.56.2	wit + vernikkeld met tuimelschakelaar chroom blanc et laiton nickelé satiné avec manette chromée	1
60.308.57.2	wit + brons met tuimelschakelaar brons blanc + laiton bronze avec manette bronze	1



60.308.44.2	wit met tuimelschakelaar chroom en draadingang blanc avec manette chromée et passage de fil	1
60.308.45.2	wit met tuimelschakelaar brons en draadingang blanc avec manette bronze et passage de fil	1



60.308.51.2	wit + vernikkeld met tuimelschakelaar chroom en draadingang blanc et laiton nickelé satiné avec manette chromée et passage de fil	1
60.308.53.2	wit + brons met tuimelschakelaar brons en draadingang blanc + laiton bronze avec manette bronze et passage de fil	1

## FRAME

Adapter  
Adaptateur



artikel article	omschrijving description	
60.952.03.2	voor afdekplaat Garby met ingang pour socle Garby avec entrée	1

▲ Analoge en digitale tijdschakelaars  
 ▲ Interrupteurs horaires analogiques et digitaux



**UNO**

Analoge schakelklokken  
 Interrupteurs horaires analogiques

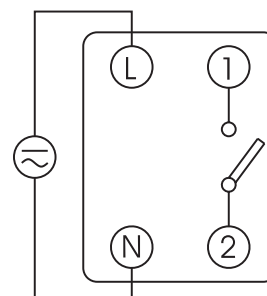
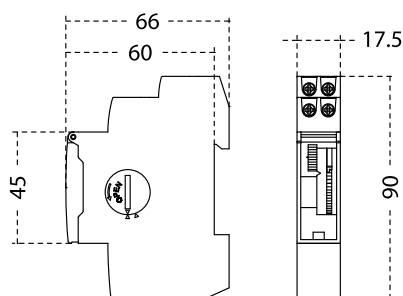

artikel / article	UNOD	UNOQRD	UNOQRS
gangreserve réserve de marche	zonder gangreserve sans réserve	meer dan 150 u, vervangbare batterij plus de 150 h, batterie interchangeable	
programma / programme	dagelijks, 15 min. quotidien, 15 min.		wekelijks, 2 u hebdomadaire, 2 h
spanning / tension	12, 24, 120 of/ou 230 Vac 12, 24 of/ou 48 Vdc		
nominale frequentie fréquence nominale	50/60 Hz		
schakelvermogen pouvoir de rupture	16 (4) A/250 Vac		
contact	1 maakcontact / 1 contact simple		
gloeilampen lampes incandescence	2500 W		
fluorescentielampen lampes fluorescentes	1200 VA		
halogeenlampen met transfo lampes halogènes avec transfo	2000 VA		
230 V halogeenlampen lampes halogènes 230 V	2500 W		
spaarlampen / LFC	900 VA		
LED lampen / lampes LED	100 VA		
temperatuur / température	-10° +45° C		
installatie / installation	DIN rail / Rail DIN		
beschermingsgraad indice de protection	IP20		

- ▲ Analoge en digitale tijdschakelaars
- ▲ Interrupteurs horaires analogiques et digitaux

**INCA DUO**

Analoge schakelklokken  
Interrupteurs horaires analogiques

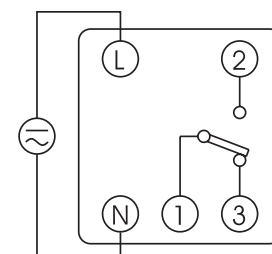
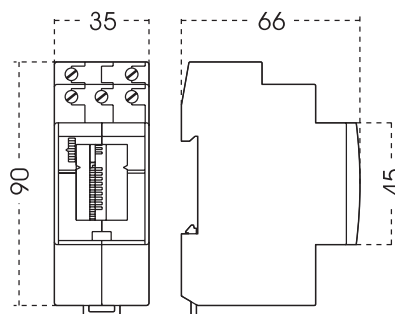

artikel / article	INCADUOD	INCADUOQRD	INCADUOQRS
gangreserve réserve de marche	zonder gangreserve sans réserve	meer dan 100 u / plus de 100 h	
programma / programme	dagelijks, 15 min. quotidien, 15 min.		wekelijks, 2 u hebdomadaire, 2 h
spanning / tension	12, 24, 120 of/ou 230 Vac 12, 24 of/ou 48 Vdc		
nominale frequentie fréquence nominale	50/60 Hz		
schakelvermogen pouvoir de rupture	16 (4) A/250 Vac		
contact	1 wisselcontact / 1 contact commuté		
gloeilampen lampes incandescence	3000 W		
fluorescentielampen lampes fluorescentes	1200 VA		
halogeenlampen met transfo lampes halogènes avec transfo	2000 VA		
230 V halogeenlampen lampes halogènes 230 V	3000 W		
spaarlampen / LFC	900 VA		
LED lampen / lampes LED	100 VA		
temperatuur / température	-10° +45° C		
installatie / installation	DIN rail / Rail DIN		
beschermingsgraad indice de protection	IP20		

▲ Analoge en digitale tijdschakelaars  
 ▲ Interrupteurs horaires analogiques et digitaux



**SUPRA**

Analoge schakelklokken  
 Interrupteurs horaires analogiques

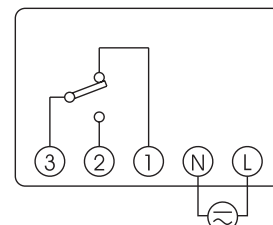
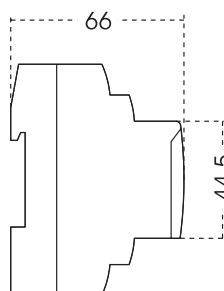
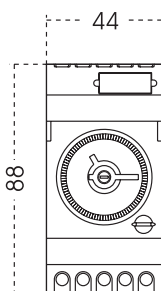

artikel / article	SUPRAD	SUPRAQRD	SUPRAQRS
gangreserve réserve de marche	zonder gangreserve sans réserve	meer dan 150 u, vervangbare batterij plus de 150 h, batterie interchangeable	
programma / programme	dagelijks, 15 min. quotidien, 15 min.		wekelijks, 2 u hebdomadaire, 2 h
spanning / tension	12, 24, 120 of/ou 230 Vac 12, 24 of/ou 48 Vdc		
nominale frequentie fréquence nominale	50/60 Hz		
schakelvermogen pouvoir de rupture	16 (4) A/250 Vac		
contact	1 wisselcontact / 1 contact commuté		
gloeilampen lampes incandescence	3000 W		
fluorescentielampen lampes fluorescentes	1200 W		
halogeenlampen met transfo lampes halogènes avec transfo	2000 VA		
230 V halogeenlampen lampes halogènes 230 V	3000 W		
spaarlampen / LFC	900 VA		
LED lampen / lampes LED	100 VA		
temperatuur / température	-10° +50° C		
installatie / installation	DIN rail / Rail DIN		
beschermingsgraad indice de protection	IP20		

- ▲ Analoge en digitale tijdschakelaars
- ▲ Interrupteurs horaires analogiques et digitaux

**CRONO**

Analoge schakelklokken

Interrupteurs horaires analogiques

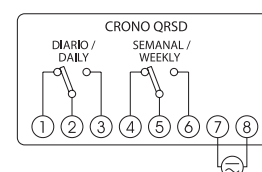
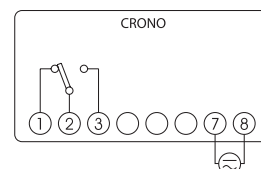
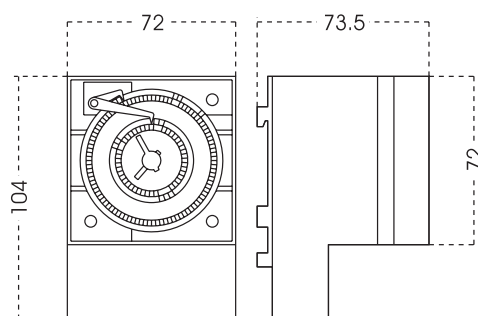

artikel / article	CRONOQRD	CRONOQRDD	CRONOQRS/D
gangreserve réserve de marche	meer dan 100 u / plus de 100 h		
programma / programme	dagelijks, 15 min. quotidien, 15 min.	dagelijks, 15 min. - 30 min. quotidien, 15 min. - 30 min.	wekelijks, 2 u - dagelijks, 30 min. hebdomadaire, 2 h quotidien, 30 min.
spanning / tension	12, 24, 120 of/ou 230 Vac 12, 24 of/ou 48 Vdc		
nominale frequentie fréquence nominale	50/60 Hz		
schakelvermogen pouvoir de rupture	16 (4) A/250 Vac	2x 16 (4) A/250 Vac	
contact	1 wisselcontact 1 contact commuté	2 wisselcontacten 2 contacts commutés	
gloeilampen lampes incandescence	3000 W		
fluorescentielampen lampes fluorescentes	500 W		
halogeenlampen met transfo lampes halogènes avec transfo	2250 VA		
230 V halogeenlampen lampes halogènes 230 V	3000 W		
spaarlampen / LFC	500 VA		
temperatuur / température	-10° +50° C		
installatie / installation	DIN rail, in- of opbouw / Rail DIN, encastré ou en saillie		
beschermingsgraad indice de protection	IP20		

▲ Analoge en digitale tijdschakelaars  
▲ Interrupteurs horaires analogiques et digitaux



**ALPHA**

Analoge schakelklokken  
Interrupteurs horaires analogiques

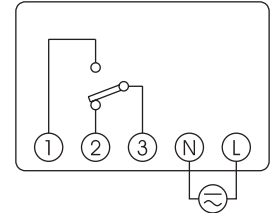
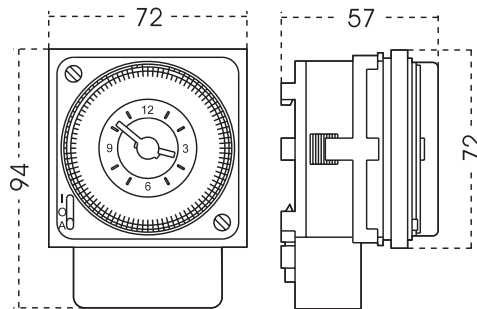

artikel / article	ALPHAD	ALPHAS	ALPHAQRD	ALPHAQRS
gangreserve réserve de marche	zonder gangreserve / sans réserve		meer dan 100 u / plus de 100 h	
programma / programme	dagelijks, 15 min. quotidien, 15 min.	wekelijks, 2 h hebdomadaire, 2 h	dagelijks, 15 min. quotidien, 15 min.	wekelijks, 2 h hebdomadaire, 2 h
spanning / tension	12, 24, 120 of/ou 230 Vac 12, 24 of/ou 48 Vdc			
nominale frequentie fréquence nominale	50/60 Hz			
schakelvermogen pouvoir de rupture	16 (4) A/250 Vac			
contact	1 wisselcontact / contact commuté			
gloeilampen lampes incandescence	2000 W			
fluorescentielampen lampes fluorescentes	1200 VA			
halogeenlampen met transfo lampes halogènes avec transfo	2000 VA			
230 V halogeenlampen lampes halogènes 230 V	2000 W			
spaarlampen / LFC	900 VA			
LED lampen / lampes LED	100 VA			
temperatuur / température	-10° +50° C			
installatie / installation	DIN rail, in- of opbouw / Rail DIN, encastré ou en saillie			
beschermingsgraad indice de protection	IP20			



- ▲ Analoge en digitale tijdschakelaars
- ▲ Interrupteurs horaires analogiques et digitaux

**DATA MICRO**

Digitale schakelklokken  
Interrupteurs horaires numériques



DATA MICRO +

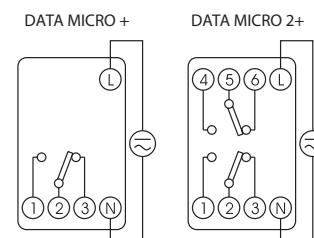
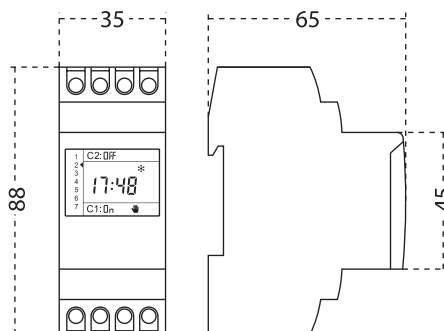

DATA MICRO 2+

artikel / article	DATA MICRO +	DATA MICRO 2+
gangreserve réserve de marche	4 jaar zonder voeding / 4 ans sans alimentation	
geheugen espaces de mémoire	32 programma's/programmes	
menu	iconen / icônes	
programming on/off programmation on/off	1 min.	
programming impulsen programmation à impulsions	1 sec.	
programma / programme	dagelijks - wekelijks / quotidien - hebdomadaire	
spanning / tension	12, 24 of/ou 48 Vac/dc - 120 of/ou 230 Vac	
nominale frequentie fréquence nominale	50/60 Hz	
contact	1 wisselcontact 1 contact commuté	2 wisselcontacten 2 contacts commutés
gloeilampen lampes incandescence	3000 W	
fluorescentielampen lampes fluorescentes	1200 VA	
halogeenlampen met transfo lampes halogènes avec transfo	2000 VA	
230 V halogeenlampen lampes halogènes 230 V	3000 W	
spaarlampen / LFC	400 VA	
LED lampen / lampes LED	90 VA	
temperatuur / température	-10° +45° C	
installatie / installation	DIN rail / Rail DIN	
beschermingsgraad indice de protection	IP20	

▲ Analoge en digitale tijdschakelaars  
 ▲ Interrupteurs horaires analogiques et digitaux



**DATA LOG**

Digitale schakelklokken  
 Interrupteurs horaires numériques



DATA LOG

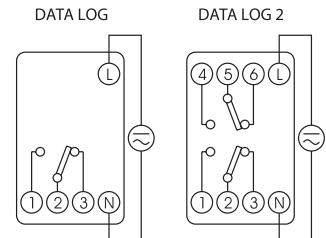
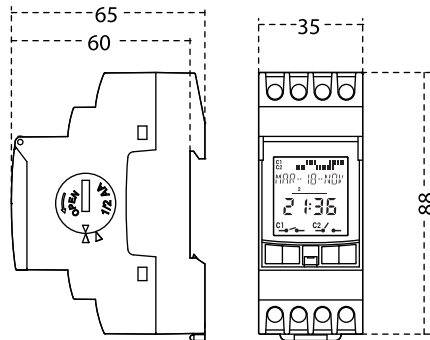

DATA LOG 2



Bluetooth adapter - zie pagina 188  
 Clé bluetooth - voir page 188

artikel / article	DATA LOG	DATA LOG 2
gangreserve réserve de marche	10 jaar zonder voeding, vervangbare batterij 10 ans sans alimentation, batterie interchangeable	
geheugen espaces de mémoire	40 programma's/programmes	
menu	tekst / texte	
programmering on/off programmation on/off	1 min.	
programmering impulsen programmation à impulsions	1 sec.	
programma / programme	dagelijks - wekelijks / quotidien - hebdomadaire	
spanning / tension	12, 24 of/ou 48 Vac/dc - 120 of/ou 230 Vac	
nominale frequentie fréquence nominale	50/60 Hz	
contact	1 wisselcontact 1 contact commuté	2 wisselcontacten 2 contacts commutés
gloeilampen lampes incandescence	3000 W	
fluorescentielampen lampes fluorescentes	1200 VA	
halogeenlampen met transfo lampes halogènes avec transfo	2000 VA	
230 V halogeenlampen lampes halogènes 230 V	3000 W	
spaarlampen / LFC	400 VA	
LED lampen / lampes LED	90 VA	
temperatuur / température	-10° +45° C	
installatie / installation	DIN rail / Rail DIN	
beschermingsgraad indice de protection	IP20	

- ▲ Analoge en digitale tijdschakelaars
- ▲ Interrupteurs horaires analogiques et digitaux

**ASTRO NOVA CITY**

Astronomische schakelklok

Interrupteur astronomique

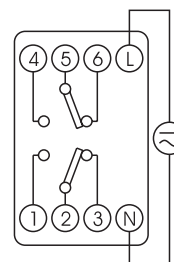
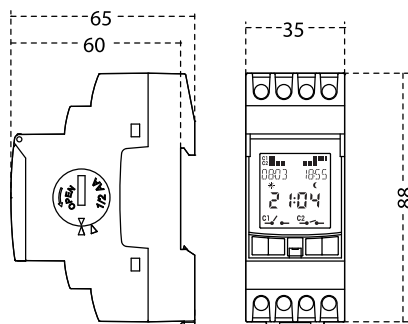

Bluetooth adapter - zie pagina 188  
Clé bluetooth - voir page 188

artikel / article	ASTRO NOVA CITY
gangreserve réserve de marche	meer dan 10 jaar zonder voeding, vervangbare batterij plus de 10 ans sans alimentation, batterie interchangeable
geheugen espaces de mémoire	40 programma's/programmes
programma / programme	dagelijks - wekelijks, 1 min. quotidien - hebdomadaire, 1 min.
spanning / tension	12, 24 of/ou 48 Vac/dc - 120 of/ou 230 Vac
nominale frequentie fréquence nominale	50/60 Hz
schakelvermogen pouvoir de rupture	2 x 16 (4) A/250 Vac
contact	1 potentiaalvrij wisselcontact 1 contact commuté sans potentiel
gloeilampen lampes incandescence	3000 W
fluorescentielampen lampes fluorescentes	1200 VA
halogeenvlampen met transfo lampes halogènes avec transfo	2000 VA
230 V halogeenvlampen lampes halogènes 230 V	3000 W
spaarlampen / LFC	400 VA
LED lampen / lampes LED	90 VA
automatische omschakeling zomer/winter changement automatique été/hiver	✓
installatie / installation	DIN rail / Rail DIN
beschermingsgraad indice de protection	IP20

**DONGLE**

Bluetooth adapter  
 Clé bluetooth



**artikel / article**

**OB709971**

**Specificaties**

- bidirectionele communicatie met DATA LOG, DATA LOG 2 en ASTRO NOVA CITY
- programmatie en configuratie aan de hand van de app voor smartphones of tablets
- compatibel met Apple (iPhone 4S, iPad 3 of hoger) & Android (version 4.3 of hoger en Bluetooth 4.0 LE)
- gratis app beschikbaar op : App Store & Google Play

**Spécifications**

- communication bidirectionnelle avec DATA LOG, DATA LOG 2 en ASTRO NOVA CITY
- programmation et configuration à partir de l'application pour les téléphones mobiles ou les tablettes
- compatible avec Apple (iPhone 4S, iPad 3 ou supérieur) & Android (version 4.3 ou supérieur et Bluetooth 4.0 LE)
- application gratuite disponible sur: App Store & Google Play



- ▲ Dimmers en bewegingsmelders
- ▲ Variateurs et détecteurs de mouvement

# DINUY

## RE PLE LE1

Dimmer LED lampen  
Variateur lampes LED

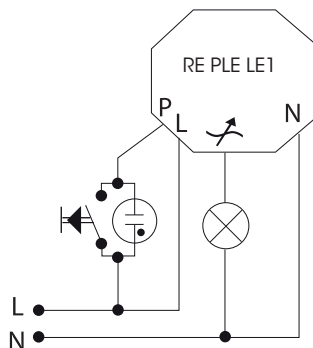

artikel / article	RE PLE LE1
spanning / tension	230 Vac 50 Hz
230 V dimbare LED 230 V LED dimmable	4 W - 100 W
12 V dimbare LED 12 V LED dimmable	1 lamp / transfo & max. 6 transfo (50 W) 1 lampe / transfo & max. 6 transfo (50 W)
controle / contrôle	drukknop / bouton poussoir
afmeting / dimension	45 x 45 x 12 mm
norm / norme	EN60669-2-1
verpakking / emballage	1

## RE EL1 LE1

Universele dimmer  
Variateur universel

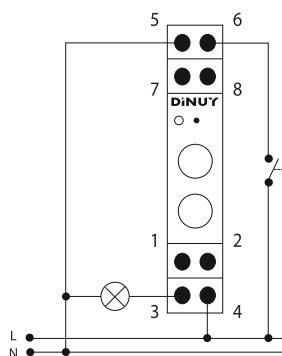

artikel / article	RE EL1 LE1
spanning / tension	230 Vac 50 Hz
230 V dimbare LED 230 V LED dimmable	4W - 100W
12 V dimbare LED 12 V LED dimmable	1 lamp / transfo & max. 6 transfo (50 W) 1 lampe / transfo & max. 6 transfo (50 W)
gloeilampen en 230 V halogeen incandescence et halogènes 230 V	15 W - 400 W
halogeen met elektronische transfo halogènes avec transfo électronique	15 W - 400 W
halogeen met elektromagnetische transfo halogènes avec transfo ferromagnétique	20 W - 250 W
dimbare spaarlampen LFC dimmable	20 W - 200 W
controle / contrôle	drukknop / bouton poussoir
afmeting / dimension	17,5 mm (1 module)
norm / norme	EN60669-2-1
verpakking / emballage	1

- ▲ Dimmers en bewegingsmelders
- ▲ Variateurs et détecteurs de mouvement

# DINUY

## RE EL5 LE1

Dimmer LED lampen  
Variateur lampes LED

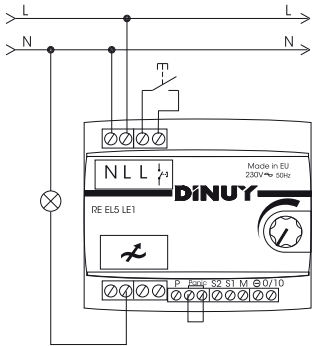

artikel / article	RE EL5 LE1
spanning / tension	230 Vac 50 Hz
230 V dimbare LED 230 V LED dimmable	1200 W
controle / contrôle	drukknop / bouton poussoir potentiometer / potentiomètre 0/10 Vdc signaal / 0/10 Vdc signal
afmeting / dimension	45 x 45 x 12 mm
norm / norme	EN60669-2-1
verpakking / emballage	1

## RE PLA LE2

Dimmer LED strips  
Variateur rubans LED

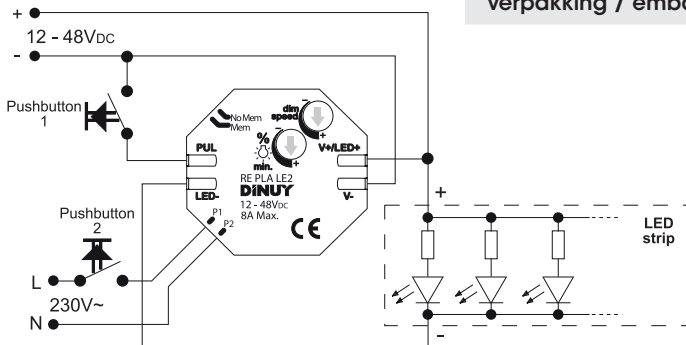
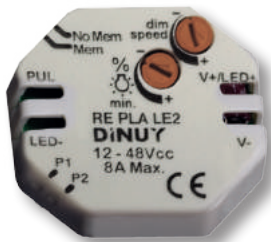

artikel / article	RE PLA LE2
spanning / tension	12 - 48 Vdc
LED strips (1 kleur) rubans LED (1 couleur)	8 A
controle / contrôle	drukknop / bouton poussoir
afmeting / dimension	45 x 45 x 12 mm
norm / norme	EN60669-2-1
verpakking / emballage	1

- ▲ Dimmers en bewegingsmelders
- ▲ Variateurs et détecteurs de mouvement

# DINUY

## RE KNX LE1

Universele dimmer  
Variateur universel

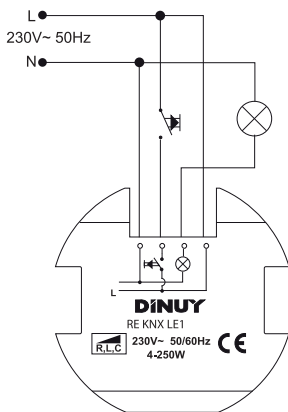
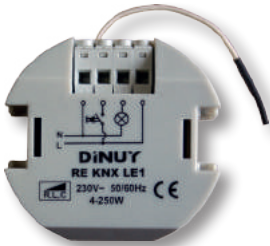

artikel / article	RE KNX LE1
spanning / tension	230 Vac 50/60 Hz
230 V dimbare LED 230 V LED dimmable	4W - 100W
12 V dimbare LED 12 V LED dimmable	1 lamp / transfo & max. 5 transfo (50 W) 1 lampe / transfo & max. 5 transfo (50 W)
gloeilampen en 230 V halogeen incandescence et halogènes 230 V	250 W
halogeen met elektronische transfo halogènes avec transfo électronique	250 W
halogeen met elektromagnetische transfo halogènes avec transfo ferromagnétique	200 W
controle / contrôle	wireless en/et drukknop/bouton poussoir
compatibel met / compatible avec	KNX-RF
bereik / portée	100 m
afmeting / dimension	17,5 mm (1 module)
norm / norme	EN60669-2-1
verpakking / emballage	1

## RE EL2 LE2

Dimmer LED strips  
Variateur rubans LED

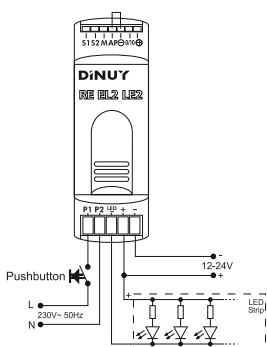

artikel / article	RE EL2 LE2
spanning / tension	12-24 Vdc
230 V dimbare LED 230 V LED dimmable	20 A
controle / contrôle	drukknop / bouton poussoir potentiometer / potentiomètre 0/10 Vdc signaal / 0/10 Vdc signal
afmeting / dimension	35 mm (2 modules)
norm / norme	EN60669-2-1
verpakking / emballage	1



- ▲ Dimmers en bewegingsmelders
- ▲ Variateurs et détecteurs de mouvement

# DINUY

## RE PLA 010

Dimmer 1/10 Vdc ballast of LED driver

Variateur 1/10 Vdc ballast ou LED driver

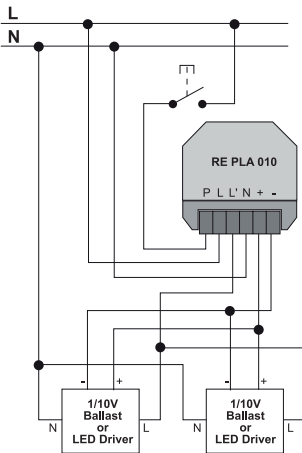

artikel / article	RE PLA 010
spanning / tension	230 Vac 50 Hz
1/10 Vdc ballast of/ou LED driver	100
max. ingangsstroom 1/10V max. courant d'entrée 1/10V	250 mA
max. uitgangsstroom 1/10V max. courant de sortie 1/10V	50 mA
controle / contrôle	drukknop / bouton poussoir
afmeting / dimension	55 x 53 x 34 mm
norm / norme	EN60669-2-1
verpakking / emballage	1

## RE PLA DA1

Dimmer Dali ballast of LED driver

Variateur Dali ballast ou LED driver

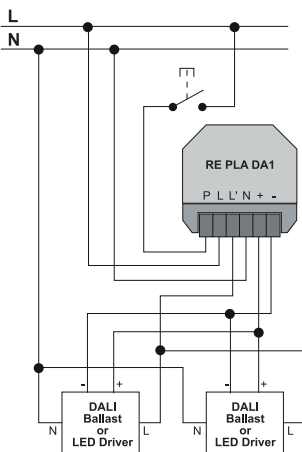

artikel / article	RE PLA DA1
spanning / tension	230 Vac 50 Hz
Dali ballast of/ou LED driver	64
controle / contrôle	drukknop / bouton poussoir
afmeting / dimension	55 x 53 x 34 mm
norm / norme	EN60669-2-1
verpakking / emballage	1

- ▲ Dimmers en bewegingsmelders
- ▲ Variateurs et détecteurs de mouvement

# DINUY

## RE EL5 002

Dimmer 1/10 Vdc  
Variateur 1/10 Vdc

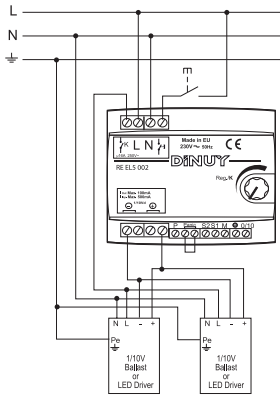

artikel / article	RE EL5 002
spanning / tension	230 Vac 50 Hz
1/10 Vdc ballast	200
controle / contrôle	drukknop / bouton poussoir
	potentiometer / potentiomètre
	0/10 Vdc signaal / 0/10 Vdc signal
afmeting / dimension	87,5 mm (5 modules)
norm / norme	EN60669-2-1
verpakking / emballage	1

## RE EL5 DA1

Dimmer Dali  
Variateur Dali

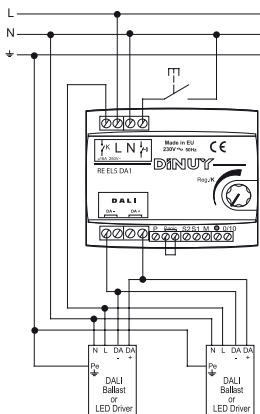

artikel / article	RE EL5 DA1
spanning / tension	230 Vac 50 Hz
Dali ballast	64
controle / contrôle	drukknop / bouton poussoir
	potentiometer / potentiomètre
	0/10 Vdc signaal / 0/10 Vdc signal
afmeting / dimension	87,5 mm (5 modules)
norm / norme	EN60669-2-1
verpakking / emballage	1

- ▲ Dimmers en bewegingsmelders
- ▲ Variateurs et détecteurs de mouvement

# DINUY

**RE PLE 000**

Dimmer voor gloei- en halogeenlampen

Variateur pour lampes à incandescence et lampes halogènes

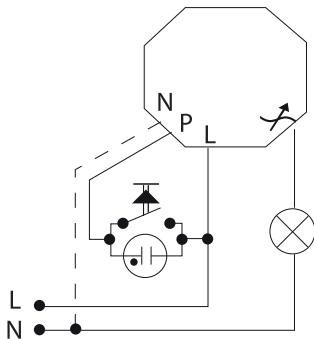

artikel / article	RE PLE 000
spanning / tension	230 Vac 50 Hz
gloeilampen en 230 V halogeen incandescence et halogènes 230 V	15 W - 400 W
halogeen met elektronische transfo (L of C) halogènes avec transfo électronique (L ou C)	20 W - 250 W
halogeen met elektromagnetische transfo halogènes avec transfo ferromagnétique	15 W - 400 W
controle / contrôle	drukknop / bouton poussoir
afmeting / dimension	45 x 45 x 12 mm
norm / norme	EN60669-2-1
verpakking / emballage	1

- ▲ Dimmers en bewegingsmelders
- ▲ Variateurs et détecteurs de mouvement

# DINUY

## RE EL2 E00

Dimmer voor gloei- en halogeenlampen

Variateur pour lampes à incandescence et lampes halogènes

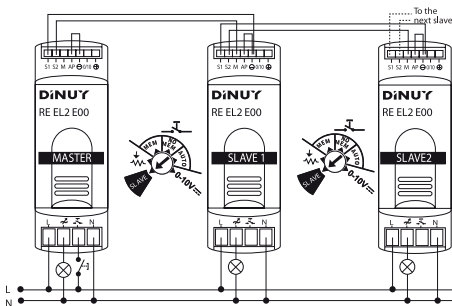

artikel / article	RE EL2 E00
spanning / tension	230 Vac 50 Hz
gloeilampen en 230 V halogeen incandescence et halogènes 230 V	25 W - 750 W
halogeen met elektronische transfo (L of C) halogènes avec transfo électronique (L ou C)	35 W - 750 W
halogeen met elektromagnetische transfo halogènes avec transfo ferromagnétique	20 W - 750 W
controle / contrôle	druknop / bouton poussoir
	potentiometer / potentiomètre
	0/10 Vdc signaal / 0/10 Vdc signal
afmeting / dimension	87,5 mm (5 modules)
norm / norme	EN60669-2-1
verpakking / emballage	1

## RE EL5 E00

Dimmer voor gloei- en halogeenlampen

Variateur pour lampes à incandescence et lampes halogènes

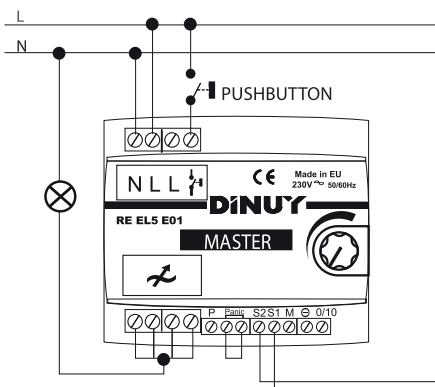

artikel / article	RE EL5 E00
spanning / tension	230 Vac 50 Hz
gloeilampen en 230 V halogeen incandescence et halogènes 230 V	100 W - 1000 W
halogeen met elektronische transfo (L of C) halogènes avec transfo électronique (L ou C)	100 W - 1000 W
halogeen met elektromagnetische transfo halogènes avec transfo ferromagnétique	100 W - 1000 W
controle / contrôle	druknop / bouton poussoir
	potentiometer / potentiomètre
	0/10 Vdc signaal / 0/10 Vdc signal
afmeting / dimension	87,5 mm (5 modules)
norm / norme	EN60669-2-1
verpakking / emballage	1

- ▲ Dimmers en bewegingsmelders
- ▲ Variateurs et détecteurs de mouvement

# DINUY

## RE DMS 001

Constant light control inbouw, 1/10 Vdc  
Constant light control encastré, 1/10 Vdc

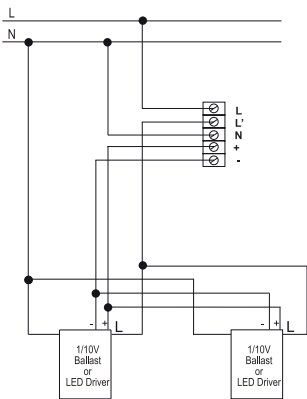

artikel / article	RE DMS 001
spanning / tension	230 Vac 50 Hz
1-10 Vdc ballast of LED driver 1-10 Vdc ballast ou LED driver	80
bereik bewegingsdetectie couverture de détection de mouvement	Ø 7 m x h 2,5 m
helderheidsniveau niveau de luminosité	100 -1000 Lux
vertraging / délai	10 - 30 min.
montage / montage	inbouw / encastré
norm / norme	EN60669-2-1
verpakking / emballage	1

## RE DMS 004

Constant light control opbouw, 1/10 Vdc  
Constant light control en saillie, 1/10 Vdc

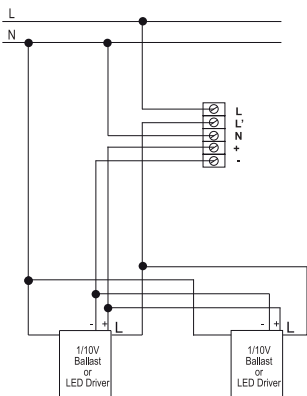

artikel / article	RE DMS 004
spanning / tension	230 Vac 50 Hz
1-10 Vdc ballast of LED driver 1-10 Vdc ballast ou LED driver	80
bereik bewegingsdetectie couverture de détection de mouvement	Ø 7 m x h 2,5 m
helderheidsniveau niveau de luminosité	100 -1000 Lux
vertraging / délai	10 - 30 min.
montage / montage	opbouw / en saillie
norm / norme	EN60669-2-1
verpakking / emballage	1

- ▲ Dimmers en bewegingsmelders
- ▲ Variateurs et détecteurs de mouvement

# DINUY

## RE DMS DA1

Constant light control inbouw, DALI  
Constant light control inbouw, DALI

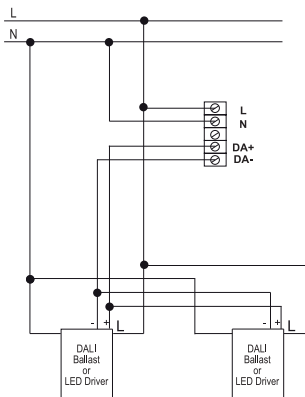

artikel / article	RE DMS DA1
spanning / tension	230 Vac 50 Hz
Dali ballast of LED driver Dali ballast ou LED driver	80
bereik bewegingsdetectie couverture de détection de mouvement	Ø 7 m x h 2,5 m
helderheidsniveau niveau de luminosité	100 -1000 Lux
vertraging /délai	10 - 30 min.
montage / montage	inbouw / encastré
norm / norme	EN60669-2-1
verpakking / emballage	1

## RE DMS DA4

Constant light control opbouw, DALI  
Constant light control en saillie, DALI

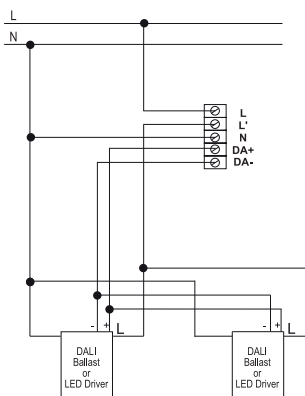

artikel / article	RE DMS DA4
spanning / tension	230 Vac 50 Hz
Dali ballast of LED driver Dali ballast ou LED driver	80
bereik bewegingsdetectie couverture de détection de mouvement	Ø 7 m x h 2,5 m
helderheidsniveau niveau de luminosité	100 -1000 Lux
vertraging /délai	10 - 30 min.
montage / montage	opbouw / en saillie
norm / norme	EN60669-2-1
verpakking / emballage	1

- ▲ Dimmers en bewegingsmelders
- ▲ Variateurs et détecteurs de mouvement

# DINUY

## CO REG R05

Afstandsbediening voor constant light control  
Télécommande pour constant light control



artikel / article	CO REG R05
dimmers / variateurs	RE DMS 001, RE DMS 004, RE DMS DA1 en RE DMS DA4
verpakking / emballage	1

## RC KNX 001

Afstandsbediening  
Télécommande



artikel / article	RC KNX 001
spanning / tension	230 Vac 50 Hz
radiofrequentie fréquence radio	868,4 MHz
reikwijdte / portée	100 m
afmeting / dimension	17,5 mm (1 module)
dimmers / variateurs	RE KNX LE1 & CO KNX 001
verpakking / emballage	1



- ▲ Dimmers en bewegingsmelders
- ▲ Variateurs et détecteurs de mouvement

# DINUY

## DM BRA 000

180° bewegingsmelder

Détecteur de mouvement 180°

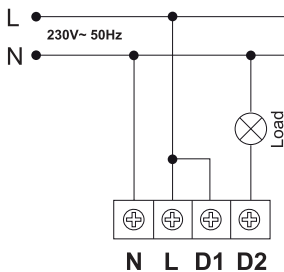

artikel article	DM BRA 000
spanning / tension	230 Vac 50 Hz
LED lampen lampes LED	400 W
gloeilampen lampes incandescence	2000 W
230 V halogeenlampen lampes halogènes 230 V	1000 W
halogeen met elektronische transfo halogènes avec transfo électronique	600 W
halogeen met elektromagnetische transfo halogènes avec transfo ferromagnétique	600 W
fluorescentielampen lampes fluorescentes	900 VA (100µF)
spaarlampen LFC	400 W
reikwijdte / portée	180°, 12 m op 2 m hoog 180°, 12 m à 2 m de haut
tijdsinstellingen / temporisation	5 sec - 30 min, test & impuls/impulsion
lichtsensor / luminosité	5 Lux - 500 Lux
gevoeligheid / sensibilité	regelbaar / réglable
temperatuur / température	-10° C +45° C
beschermingsgraad / indice de protection	IP55
verpakking / emballage	1

Wall mount:

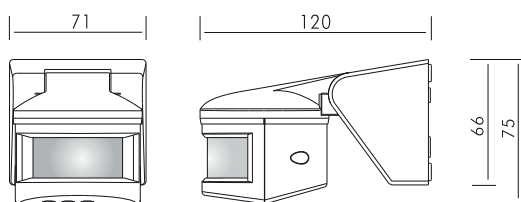

Ceiling mount:

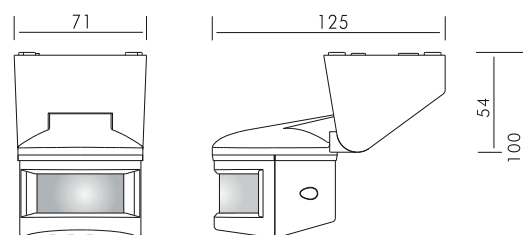

**DM CAM 001**

Bewegingsmelder voor inbouwdoos  
Détecteur de mouvement pour boîtier

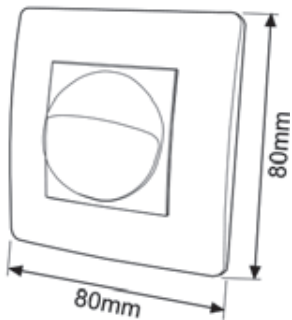
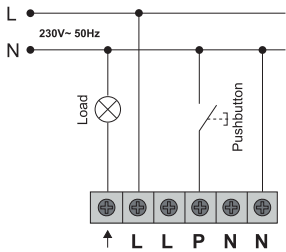

artikel article	<b>DM CAM 001</b>
installatie / installation	3 aansluitdraden / 3 fils de raccordement
spanning / tension	230 Vac 50 Hz
230 V LED lampen lampes LED 230 V	900 W
gloeilampen lampes incandescence	3000 W
230 V halogeenlampen lampes halogènes 230 V	3000 W
halogeen met elektronische transfo halogènes avec transfo électronique	3000 W
halogeen met elektromagnetische transfo halogènes avec transfo ferromagnétique	2400 W
fluorescentielampen lampes fluorescentes	1300 W (100µF)
spaarlampen LFC	18 x 7 W, 12 x 11 W, 10 x 15W, 10 x 20 W, 10 x 23 W
reikwijdte / portée	200°, 8 m op 1,5 m hoog 200°, 8 m à 1,5 m de haut
tijdsinstellingen / temporisation	30 sec - 10 min
lichtsensor / luminosité	3 Lux - 100 Lux
gevoeligheid / sensibilité	regelbaar / réglable (EM MAN DM0)
beschermingsgraad / indice de protection	IP40 (class II)
verpakking / emballage	1

- ▲ Dimmers en bewegingsmelders
- ▲ Variateurs et détecteurs de mouvement

# DINUY

## DM CAM 003

Bewegingsmelder voor inbouwdoos  
Détecteur de mouvement pour boîtier

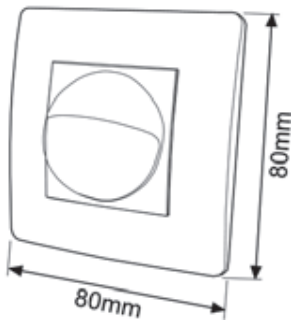
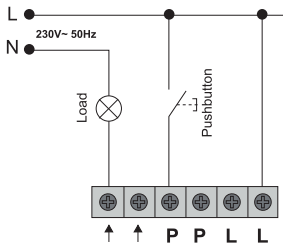

artikel article	DM CAM 003
installatie / installation	2 aansluitdraden met compensator 2 fils avec compensateur
spanning / tension	230 Vac 50 Hz
230 V LED lampen lampes LED 230 V	3 - 100 W (max 16 lampen/ lampes)
gloeilampen lampes incandescence	3 - 200 W
230 V halogeenlampen lampes halogènes 230 V	3 - 200 W
halogeen met elektronische transfo halogènes avec transfo électronique	3 - 100 W (types LC)
halogeen met elektromagnetische transfo halogènes avec transfo ferromagnétique	3 - 150 W
fluorescentielampen lampes fluorescentes	5 - 100 W(10µF)
spaarlampen LFC	5 - 100 W (max 8 lampen / lampes)
reikwijdte / portée	200°, 8 m op 1,5 m hoog 200°, 8 m à 1,5 m de haut
tijdsinstellingen / temporisation	30 sec - 10 min of/ou pulse (4 sec ON - 30 sec OFF)
lichtsensor / luminosité	3 Lux - 100 Lux
beschermingsgraad / indice de protection	IP40 (class II)
verpakking / emballage	1

**DM HF1 000**

bewegingsmelder met radiozender/-ontvanger  
détecteur de mouvement à émetteur/récepteur radio

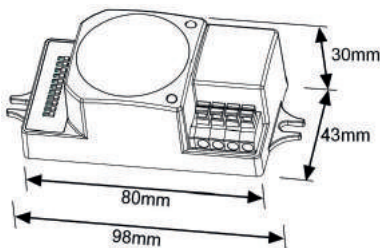
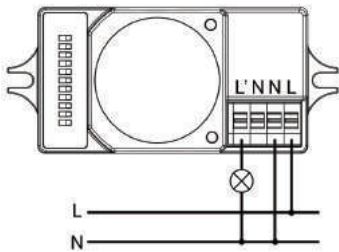

artikel article	<b>DM HF1 000</b>
spanning / tension	230 Vac 50 Hz
LED lampen lampes LED	400 W
gloeilampen lampes incandescence	1200 W
230 V halogeenlampen lampes halogènes 230 V	1200 W
halogeen met elektronische transfo halogènes avec transfo électronique	1200 W
halogeen met elektromagnetische transfo halogènes avec transfo ferromagnétique	400 W
fluorescentielampen lampes fluorescentes	400 W
spaarlampen LFC	400 W
reikwijdte / portée	30-150°, Ø 14 m op 3 m hoog 30-150°, Ø 14 m à 3 m de haut
tijdsinstellingen / temporisation	5 sec - 30 min
lichtsensor / luminosité	2 Lux - 50 Lux
microwave power	< 0,2 mW
temperatuur / température	-35° C / +70° C
beschermingsgraad / indice de protection	IP20
verpakking / emballage	1

- ▲ Dimmers en bewegingsmelders
- ▲ Variateurs et détecteurs de mouvement

# DINUY

## DM SUP 000

180° bewegingsmelder

Détecteur de mouvement 180°

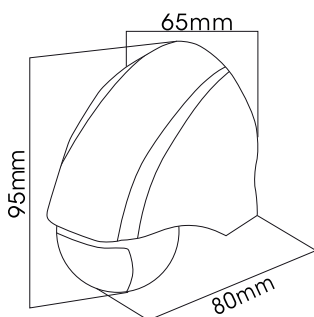
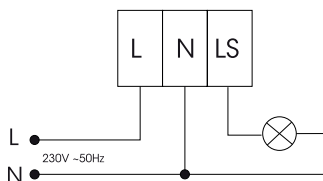

artikel article	DM SUP 000
spanning / tension	230 Vac 50 Hz
230 V LED lampen lampes LED 230 V	1300 W
gloeilampen lampes incandescence	3000 W
230 V halogeenlampen lampes halogènes 230 V	3000 W
halogeen met elektronische transfo halogènes avec transfo électronique	3000 W
halogeen met elektromagnetische transfo halogènes avec transfo ferromagnétique	2400 W
fluorescentielampen lampes fluorescentes	1300 W (130µF)
spaarlampen LFC	18 x 7 W, 12 x 11 W, 10 x 15W, 10 x 20 W, 10 x 23 W
reikwijdte / portée	180°, 12 m op 2 m hoog 180°, 12 m à 2 m de haut
tijdsinstellingen / temporisation	5 sec - 10 min
lichtsensor / luminosité	3 Lux - 100 Lux
gevoeligheid / sensibilité	regelbaar / réglable
temperatuur / température	-20° C +40° C
beschermingsgraad / indice de protection	IP44
verpakking / emballage	1

**DM SUP 002**

240° bewegingsmelder

Détecteur de mouvement 240°

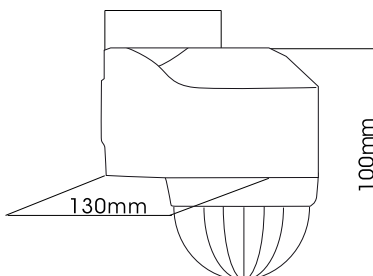
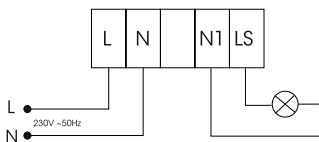

artikel article	<b>DM SUP 002</b>
spanning / tension	230 Vac 50 Hz
230 V LED lampen lampes LED 230 V	1300 W
gloeilampen lampes incandescence	3000 W
230 V halogeenlampen lampes halogènes 230 V	3000 W
halogeen met elektronische transfo halogènes avec transfo électronique	3000 W
halogeen met elektromagnetische transfo halogènes avec transfo ferromagnétique	2400 W
fluorescentielampen lampes fluorescentes	1300 W (130µF)
spaarlampen LFC	18 x 7 W, 12 x 11 W, 10 x 15W, 10 x 20 W, 10 x 23 W
reikwijdte / portée	240°, 12 m op 2 m hoog 240°, 12 m à 2 m de haut
tijdsinstellingen / temporisation	5 sec - 10 min
lichtsensor / luminosité	3 Lux - 100 Lux
gevoeligheid / sensibilité	regelbaar / réglable
temperatuur / température	-20° C +40° C
beschermingsgraad / indice de protection	IP54
verpakking / emballage	1

- ▲ Dimmers en bewegingsmelders
- ▲ Variateurs et détecteurs de mouvement

# DINUY

## DM TEC 000

Minibewegingsmelder

Mini détecteur de mouvement



artikel article	<b>DM TEC 000</b>
spanning / tension	230 Vac 50 Hz
230 V LED lampen lampes LED 230 V	500 VA/400 W
gloeilampen lampes incandescence	2000 W
230 V halogeenlampen lampes halogènes 230 V	1000 W
halogeen met transfo halogènes avec transfo	1000 VA/600 W
fluorescentielampen lampes fluorescentes	900 VA (100µF)
spaarlampen LFC	600 VA/400 W
reikwijdte / portée	360°, 6 m op 2,5 m hoog 360°, 6 m à 2,5 m de haut
tijdsinstellingen / temporisation	1 sec - 15 min, test
lichtsensor / luminosité	10 Lux - 100 Lux
gevoeligheid / sensibilité	regelbaar / réglable
temperatuur / température	0° C +45° C
beschermingsgraad / indice de protection	IP20
verpakking / emballage	1

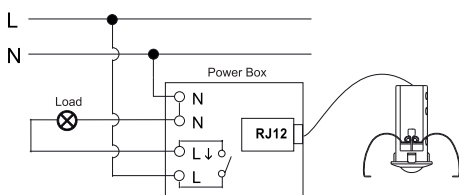



**DM TEC 001**

360° Opbouwbewegingsmelder met 7 m reikwijdte

Détecteur de mouvement en saillie 360° avec une portée de 7 m

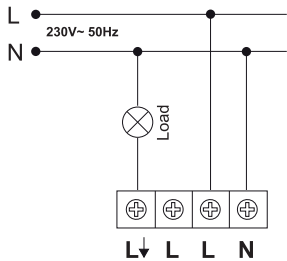

artikel article	<b>DM TEC 001</b>
spanning / tension	230 Vac 50 Hz
230 V LED lampen lampes LED 230 V	1300 W
gloeilampen lampes incandescence	3000 W
230 V halogeenlampen lampes halogènes 230 V	3000 W
halogeen met elektronische transfo halogènes avec transfo électronique	3000 W
halogeen met elektromagnetische transfo halogènes avec transfo ferromagnétique	2400 W
fluorescentielampen lampes fluorescentes	1300 W (130µF)
spaarlampen LFC	18 x 7 W, 12 x 11 W, 10 x 15W, 10 x 20 W, 10 x 23 W
reikwijdte / portée	360°, 7 m op 2,5 m hoog 360°, 7 m à 2,5 m de haut
tijdsinstellingen / temporisation	6 sec - 12 min
lichtsensor / luminosité	3 Lux - 100 Lux
gevoeligheid / sensibilité	regelbaar / réglable (EM MAN DM0)
aantal slaves / nombre de slaves	0
temperatuur / température	-10° C +45° C
beschermingsgraad / indice de protection	IP40
verpakking / emballage	1

- ▲ Dimmers en bewegingsmelders
- ▲ Variateurs et détecteurs de mouvement

# DINUY

## DM TEC 003

360° Inbouwbewegingsmelder met 7 m reikwijdte

Détecteur de mouvement encastré 360° avec une portée de 7 m

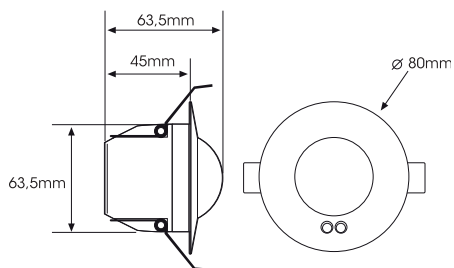
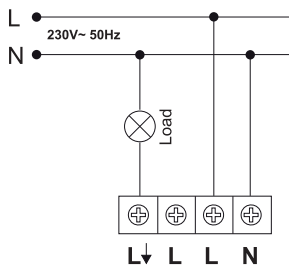

artikel article	<b>DM TEC 003</b>
spanning / tension	230 Vac 50 Hz
230 V LED lampen lampes LED 230 V	1300 W
gloeilampen lampes incandescence	3000 W
230 V halogeenlampen lampes halogènes 230 V	3000 W
halogeen met elektronische transfo halogènes avec transfo électronique	3000 W
halogeen met elektromagnetische transfo halogènes avec transfo ferromagnétique	2400 W
fluorescentielampen lampes fluorescentes	1300 W (130µF)
spaarlampen LFC	18 x 7 W, 12 x 11 W, 10 x 15W, 10 x 20 W, 10 x 23 W
reikwijdte / portée	360°, 7 m op 2,5 m hoog 360°, 7 m à 2,5 m de haut
tijdsinstellingen / temporisation	6 sec - 12 min
lichtsensor / luminosité	3 Lux - 100 Lux
gevoeligheid / sensibilité	regelbaar / réglable (EM MAN DM0)
aantal slaves / nombre de slaves	0
temperatuur / température	-10° C +45° C
beschermingsgraad / indice de protection	IP40
verpakking / emballage	1

- ▲ Dimmers en bewegingsmelders
- ▲ Variateurs et détecteurs de mouvement

# DINUY

## DM TEC 004

Master voor DM SEN T03

Master pour DM SEN T03

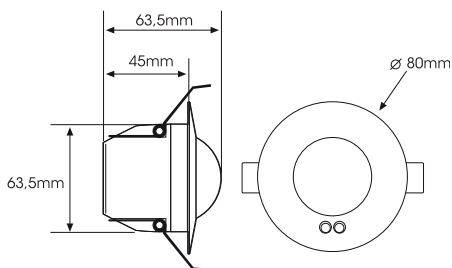
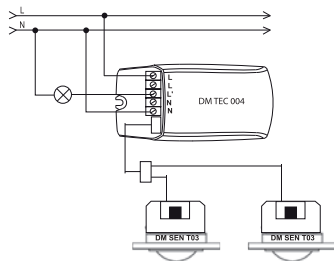

artikel article	<b>DM TEC 004</b>
spanning / tension	230 Vac 50 Hz
230 V LED lampen lampes LED 230 V	1300 W
gloeilampen lampes incandescence	3000 W
230 V halogeenlampen lampes halogènes 230 V	3000 W
halogeen met elektronische transfo halogènes avec transfo électronique	3000 W
halogeen met elektromagnetische transfo halogènes avec transfo ferromagnétique	2400 W
fluorescentielampen lampes fluorescentes	1300 W (130µF)
spaarlampen LFC	18 x 7 W, 12 x 11 W, 10 x 15W, 10 x 20 W, 10 x 23 W
reikwijdte / portée	360°, 7 m op 2,5 m hoog 360°, 7 m à 2,5 m de haut
tijdsinstellingen / temporisation	6 sec - 12 min
lichtsensor / luminosité	3 Lux - 100 Lux
gevoeligheid / sensibilité	regelbaar / réglable (EM MAN DMO)
aantal slaves / nombre de slaves	14
temperatuur / température	-10° C +45° C
beschermingsgraad / indice de protection	IP40
verpakking / emballage	1

- ▲ Dimmers en bewegingsmelders
- ▲ Variateurs et détecteurs de mouvement

# DINUY

## DM SEN T03

Slave voor DMTEC 004

Slave pour DMTEC 004



artikel article	<b>DM SEN T03</b>
reikwijdte / portée	360°, 7 m op 2,5 m hoog 360°, 7 m à 2,5 m de haut
tijdsinstellingen / temporisation	6 sec - 12 min
gevoeligheid / sensibilité	regelbaar / réglable (EM MAN DM0)
temperatuur / température	-10° C +45° C
beschermingsgraad / indice de protection	IP40
verpakking / emballage	1

**DM TEC 300**

High end bewegingsmelder

Détecteur de mouvement haut de gamme

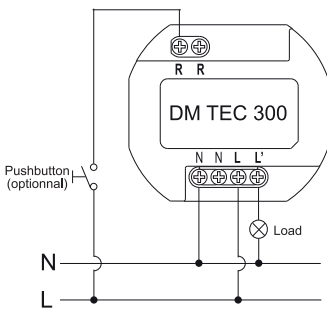

artikel article	<b>DM TEC 300</b>
spanning / tension	230 Vac 50 Hz
230 V LED lampen lampes LED 230 V	400 W
gloeilampen lampes incandescence	2000 W
230 V halogeenlampen lampes halogènes 230 V	1000 W
halogeen met elektronische transfo halogènes avec transfo électronique	900 W
halogeen met elektromagnetische transfo halogènes avec transfo ferromagnétique	600 W
fluorescentielampen lampes fluorescentes	900 W (100µF)
spaarlampen LFC	400 W
reikwijdte / portée	360°, 30 m op 2,5 m hoog 360°, 30 m à 2,5 m de haut
tijdsinstellingen / temporisation	10 sec - 30 min & impuls/impulsion
lichtsensor / luminosité	10 Lux - 2000 Lux
gevoeligheid / sensibilité	regelbaar / réglable (EM MAN DM1)
temperatuur / température	-20° C +45° C
beschermingsgraad / indice de protection	IP40 (inbouw / encastré) IP 44 (opbouw / saillie)
verpakking / emballage	1

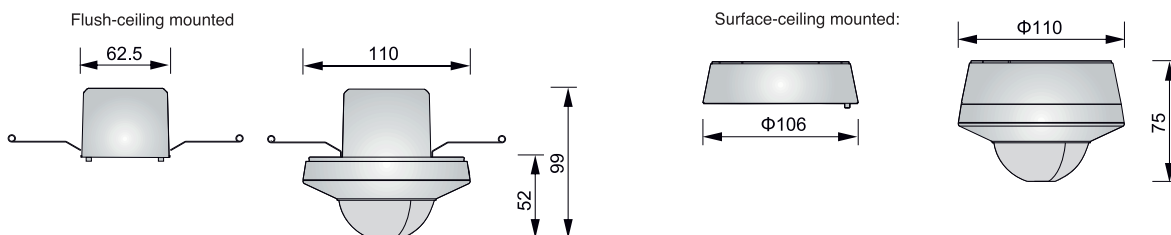

- ▲ Dimmers en bewegingsmelders
- ▲ Variateurs et détecteurs de mouvement

# DINUY

## DM TEC 010

High bay bewegingsmelder

Détecteur de mouvement high bay

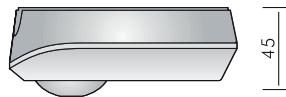
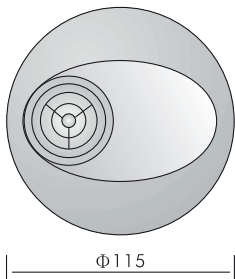
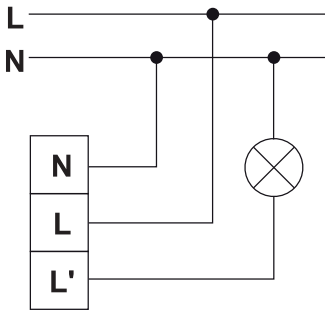

artikel article	<b>DM TEC 010</b>
spanning / tension	230 Vac 50 Hz
230 V LED lampen lampes LED 230 V	400 W
gloeilampen lampes incandescence	2000 W
230 V halogeenlampen lampes halogènes 230 V	1000 W
halogeen met elektronische transfo halogènes avec transfo électronique	900 W
halogeen met elektromagnetische transfo halogènes avec transfo ferromagnétique	600 W
fluorescentielampen lampes fluorescentes	900 W (100µF)
spaarlampen LFC	400 W
reikwijdte / portée	360°, 16 m op 10 m hoog 360°, 16 m à 10 m de haut
tijdsinstellingen / temporisation	pulse, 5 sec - 10 min
lichtsensor / luminosité	10 Lux - 2000 Lux
gevoeligheid / sensibilité	regelbaar / réglable (EM MAN DM2)
temperatuur / température	-0° C +45° C
beschermingsgraad / indice de protection	IP54
verpakking / emballage	1

**DM TEC PA1**

Bewegingsmelder voor gangpaden

Détecteur de mouvement pour surveiller une allée

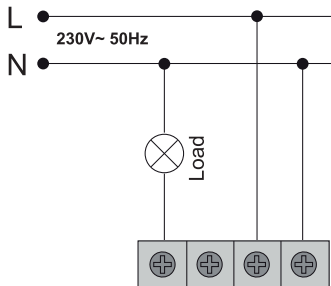

artikel article	<b>DM TEC PA1</b>
spanning / tension	230 Vac 50 Hz
230 V LED lampen lampes LED 230 V	1300 W
gloeilampen lampes incandescence	3000 W
230 V halogeenlampen lampes halogènes 230 V	3000 W
halogeen met elektronische transfo halogènes avec transfo électronique	3000 W
halogeen met elektromagnetische transfo halogènes avec transfo ferromagnétique	2400 W
fluorescentielampen lampes fluorescentes	1300 W (130µF)
spaarlampen LFC	18 x 7 W, 12 x 11 W, 10 x 15W, 10 x 20 W, 10 x 23 W
reikwijdte / portée	naar/vers: 13 m x h 2,5 m kruisen/traverser: 22 m x h 2,5 m
tijdsinstellingen / temporisation	6 sec - 12 min
lichtsensor / luminosité	3 Lux - 100 Lux
gevoeligheid / sensibilité	regelbaar / réglable (EM MAN DM0)
temperatuur / température	-10° C +45° C
beschermingsgraad / indice de protection	IP40
verpakking / emballage	1

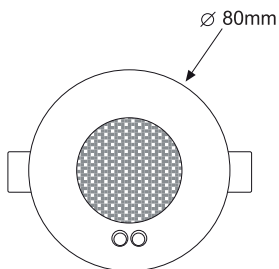
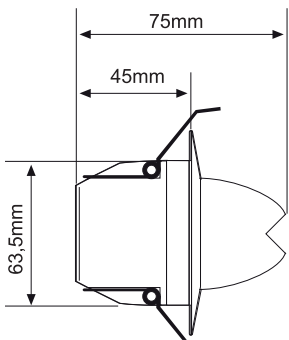



- ▲ Dimmers en bewegingsmelders
- ▲ Variateurs et détecteurs de mouvement

## EM MAN

Afstandsbediening  
Télécommande



artikel / article	<b>EM MAN DM0</b>
dimmers / variateurs	DM SUP 000, DM SUP 002, DM TEC 001, DM TEC 003, DM TEC 004 & DM SEN T03
verpakking / emballage	1
artikel / article	<b>EM MAN DM1</b>
dimmers / variateurs	DM TEC 300
verpakking / emballage	1
artikel / article	<b>EM MAN DM2</b>
dimmers / variateurs	DM TEC 010
verpakking / emballage	1

**301.1**

Enkel- of dubbelpolige schakelaars 2 A - 250 V  
Interrupteurs unipolaires ou bipolaires 2 A - 250 V



artikel article	I-polig I-pôle	platte kabel câble méplat 2 x 0,5 mm <sup>2</sup>	platte kabel câble méplat 2 x 0,75 mm <sup>2</sup>	kleur couleur	l x b x h l x l x h	
301.11	✓	✓	✓	○	60 x 27 x 16 mm	20
301.12	✓	✓	✓	●	60 x 27 x 16 mm	20
301.13	✓	✓	✓	●	60 x 27 x 16 mm	20

artikel article	II-polig II-pôles	platte kabel câble méplat 2 x 0,5 mm <sup>2</sup>	platte kabel câble méplat 2 x 0,75 mm <sup>2</sup>	kleur couleur	l x b x h l x l x h	
301.14	✓	✓	✓	○	60 x 27 x 16 mm	20
301.15	✓	✓	✓	●	60 x 27 x 16 mm	20
301.17	✓	✓	✓	●	60 x 27 x 16 mm	20

**308.0**

Enkelpolige voetschakelaars 2 A - 250 V  
Interrupteurs unipolaires à pied 2 A - 250 V



artikel article	kleur couleur	Ø x h Ø x h	
308.01	●	100 x 34 mm	20
308.04	●	100 x 34 mm	20

**308.1**

Dubbelpolige voetschakelaars 6 A - 250 V  
Interrupteurs bipolaires à pied 6 A - 250 V



artikel article	kleur couleur	
308.14	●	20

**301.4** Dubbelpolige schakelaars + aarding 10 A  
Interrupteurs bipolaires + terre 10 A



artikel article	kabel / câble 3 x 0,75 mm <sup>2</sup>	kabel / câble 3 x 1 mm <sup>2</sup>	kleur couleur	l x b x h l x l x h	
301.43	✓	✓	○	82 x 32 x 30 mm	20
301.41	✓	✓	●	82 x 32 x 30 mm	20

**302** Mini-schakelaar 2 A  
Interrupteur 2 A



artikel article	l x b x h l x l x h	
302.28	21 x 12 x 8 mm	50

**319** Peerbel voor ziekenhuizen 1 A - 250 V  
Poire sonnerie hôpital 1 A - 250 V



artikel article	kleur couleur	
319.08	○	20

**735** Zwanenhalslantaarn  
Lanterne col de cygne

IP45



**Specificaties**

- muurmontage
- binnen of buiten
- kap in geëmailleerd metaal
- heldere glaskolf
- geleverd zonder lamp

**Spécifications**

- montage mural
- intérieur ou extérieur
- abat-jour en acier émaillé
- diffuseur en verre clair
- livré sans lampe

artikel article	kleur couleur	fitting douille	halogeen halogène	klasse classe	Ø x l Ø x p	
735.19	●	E27	1 x 52 W max.	II	305 x 500 mm	1

artikel article	omschrijving description	kleur couleur	materiaal matériel	
735.11	dichting voor 735.19 / joint pour 735.19	●	rubber / caoutchouc	1
735.13	kolf 735.19 / diffuseur pour 735.19	○	glas / verre	1

**777** Wandlamp 100 W  
Hublot 100 W

IP44

IK07



**Specificaties**

- muur- of plafondmontage
- binnen of buiten
- basis in PP
- glaskolf
- geleverd zonder lamp

**Spécifications**

- montage mural ou plafonnier
- intérieur ou extérieur
- base en PP
- diffuseur en verre
- livré sans lampe

artikel article	kleur couleur	fitting douille	gloeilamp ampoule	halogeen halogène	klasse classe	Ø x l Ø x p	
777.64	○	E27	1 x 100 W max.	1 x 70 W max.	II	225 x 107 mm	1
1.777.64	○	E27	1 x 100 W max.	1 x 70 W max.	II	225 x 107 mm	5

**777** Wandlamp 75 W  
Hublot 75 W

IP44

IK04



**Specificaties**

- muur- of plafondmontage
- binnen of buiten
- basis in PP
- glaskolf
- geleverd zonder lamp

**Spécifications**

- montage mural ou plafonnier
- intérieur ou extérieur
- base en PP
- diffuseur en verre
- livré sans lampe

artikel article	kleur couleur	fitting douille	gloeilamp ampoule	halogeen halogène	klasse classe	Ø x l Ø x p	
777.44	○	E27	1 x 75 W max.	1 x 52 W max.	II	190 x 95 mm	1

**784** Wandlamp 100 W  
Hublot 100 W

IP44 IP44

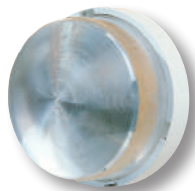

**Specificaties**

- muur- of plafondmontage
- binnen of buiten
- basis in PP
- kolf in polycarbonaat
- geleverd zonder lamp

**Spécifications**

- montage mural ou plafonnier
- intérieur ou extérieur
- base en PP
- diffuseur en polycarbonate
- livré sans lampe

artikel article	kleur couleur	fitting douille	gloeilamp ampoule	halogeen halogène	klasse classe	Ø x l Ø x p	
784.26	○	E27	1 x 100 W max.	1 x 70 W max.	II	225 x 107 mm	1

**777** Wandlamp 75 W  
Hublot 75 W

IP44 IK04



**Specificaties**

- muur- of plafondmontage
- binnen of buiten
- basis in PP
- kolf in polycarbonaat
- geleverd zonder lamp

**Spécifications**

- montage mural ou plafonnier
- intérieur ou extérieur
- base en PP
- diffuseur en polycarbonate
- livré sans lampe

artikel article	kleur couleur	fitting douille	gloeilamp ampoule	halogeen halogène	klasse classe	b x h x l l x h x p	
777.28	○	E27	1 x 75 W max.	1 x 52 W max.	II	113 x 182 x 105 mm	2

**788** Wandlamp OPTION  
Hublot OPTION

IP44 IK04



**Specificaties**

- muur- of plafondmontage
- binnen of buiten
- basis in PP
- heldere glaskolf
- geleverd zonder lamp

**Spécifications**

- montage mural ou plafonnier
- intérieur ou extérieur
- base en PP
- diffuseur en verre clair
- livré sans lampe

artikel article	kleur couleur	fitting douille	gloeilamp ampoule	halogeen halogène	klasse classe	Ø x l Ø x p	
788.17	○	E27	1 x 100 W max.	1 x 70 W max.	II	300 x 116 mm	1
1.788.17	○	E27	1 x 100 W max.	1 x 70 W max.	II	300 x 116 mm	4
788.18	●	E27	1 x 100 W max.	1 x 70 W max.	II	300 x 116 mm	1
1.788.18	●	E27	1 x 100 W max.	1 x 70 W max.	II	300 x 116 mm	4

Neem contact met ons voor meer informatie.  
 Contactez-nous pour de plus amples informations.



**EDISON**

Fittingen voor gloeilampen

Douilles pour lampes à incandescence

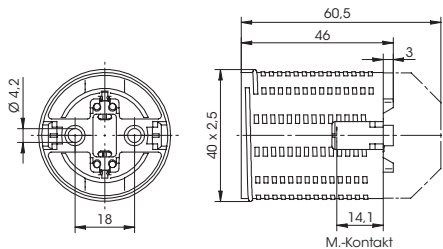

artikel article	type	kleur couleur			
22.317.3901.80	E27	●	✓	✓	50

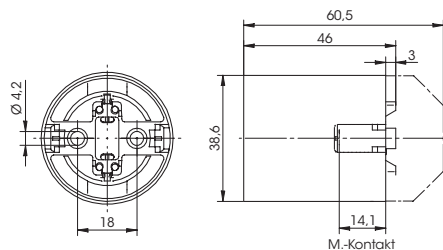

22.317.4001.50	E27	○	✓	✓	50
22.317.4001.80		●	✓	✓	50

**EDISON-ACC**

Toebehoren voor gloeilampfittingen

Accessoires de douilles pour lampes à incandescence

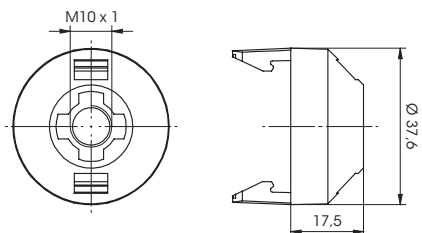

artikel article	type	kleur couleur		
22.917.-006.50	E27	○	✓	50
22.917.-006.80		●	✓	50

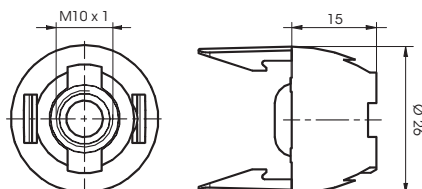

22.918.-326.50	E14	○	✓	50
22.918.-326.80		●	✓	50



Your Connection to Light

**TL**

Fittingen voor fluorescentielampen  
 Douilles pour lampes fluorescentes

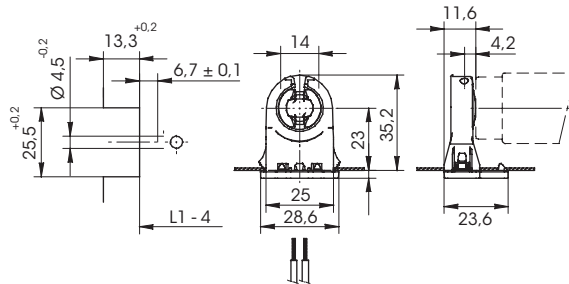

artikel article	type	CLICK	
26.290.1011.50	G13	✓	50

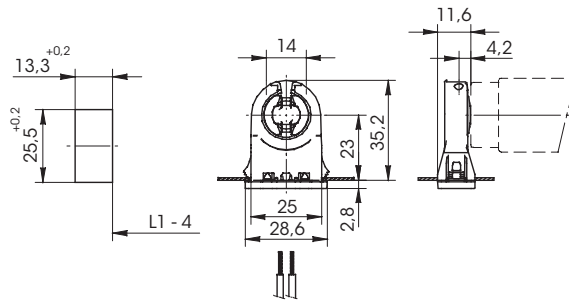

26.290.1012.50	G13	✓	50
----------------	-----	---	----

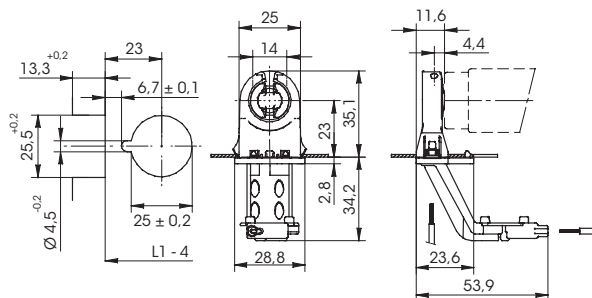

26.290.5411.50	G13	✓	50
----------------	-----	---	----

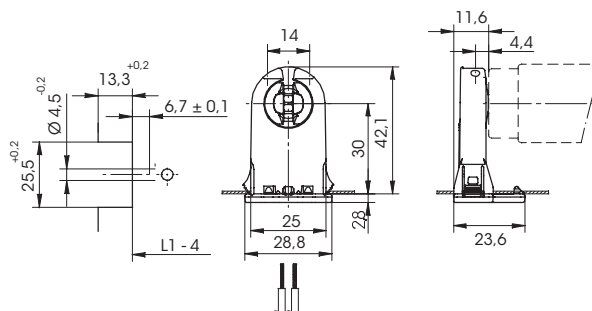

26.291.4011.50	G13	✓	50
----------------	-----	---	----



**TL** Fittingen voor fluoresciëntlampen  
 Douilles pour lampes fluorescentes

artikel article	type	CLICK	
26.291.4012.50	G13	✓	50

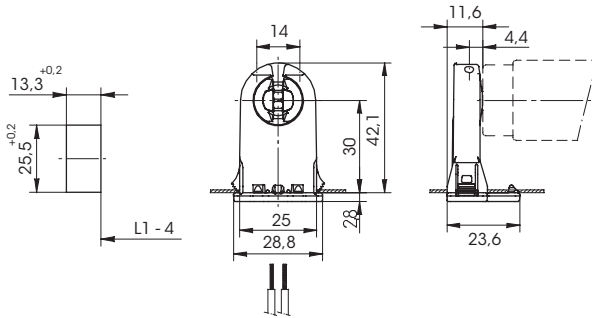

26.291.5011.50	G13	✓	50
----------------	-----	---	----

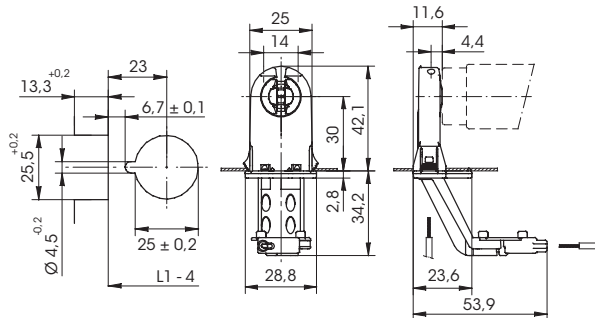

26.291.5012.50	G13	✓	50
----------------	-----	---	----

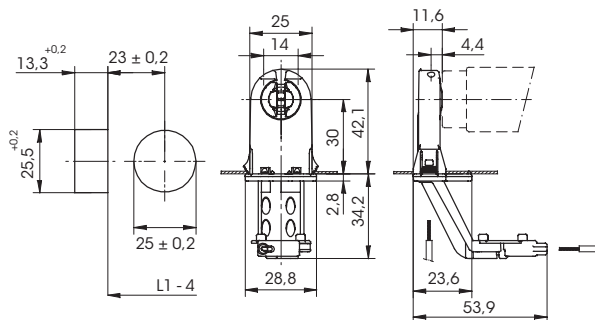

26.422.1010.50	G13	✓	500
----------------	-----	---	-----

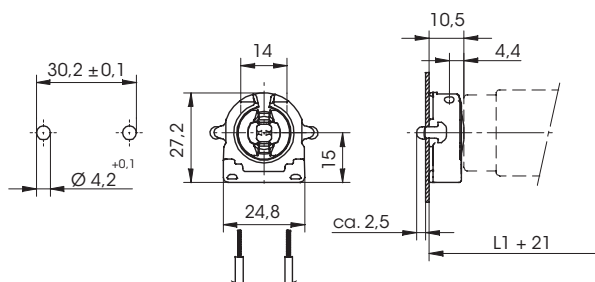



Your Connection to Light

**TL**

Fittingen voor fluorescentielampen  
 Douilles pour lampes fluorescentes

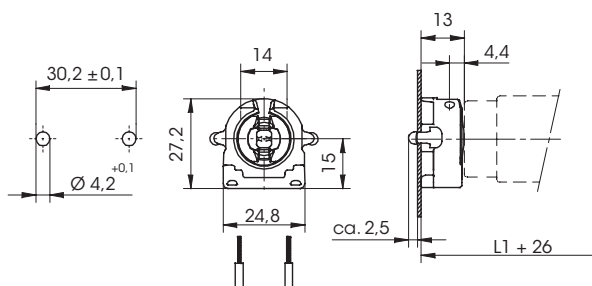

artikel article	type	CLICK	
26.422.1013.50	G13	✓	50

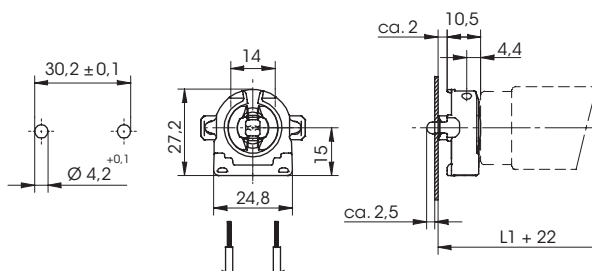

26.422.1110.50	G13	✓	500
----------------	-----	---	-----

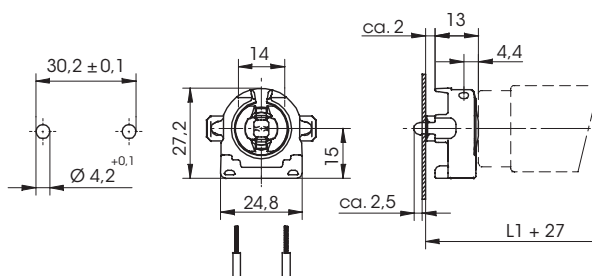

26.422.1113.50	G13	✓	50
----------------	-----	---	----

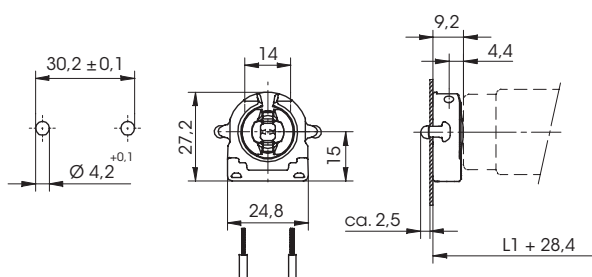

26.422.4009.50	G13	✓	500
----------------	-----	---	-----

**TL** Fittingen voor fluorescentielampen  
 Douilles pour lampes fluorescentes

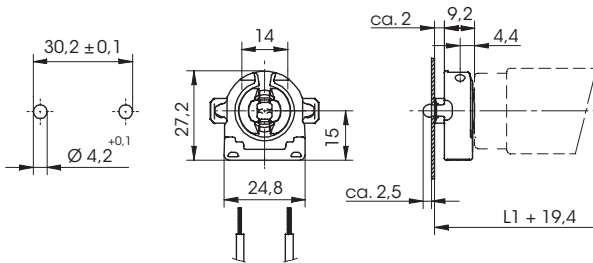

artikel article	type	CLICK	
26.422.4109.50	G13	✓	500

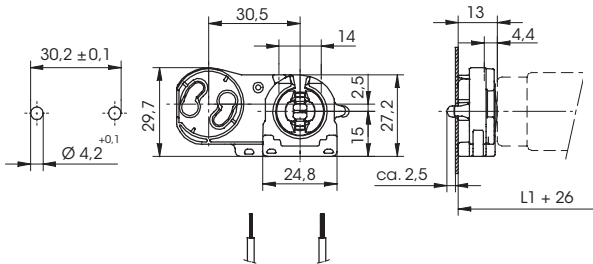

26.422.5013.50	G13	✓	50
----------------	-----	---	----

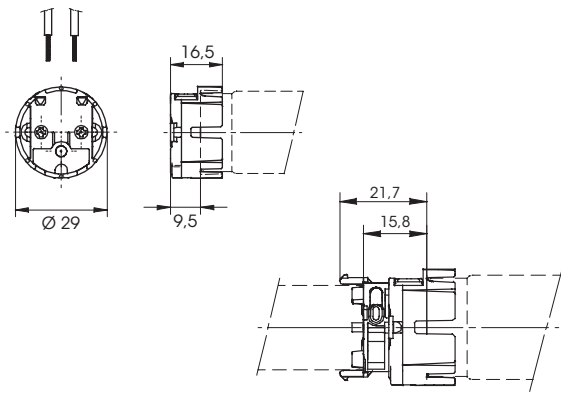

26.424.1001.50	G13	✗	500
----------------	-----	---	-----

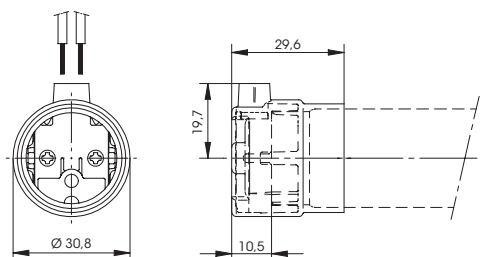

artikel article	type			CLICK	
26.424.9001.50	G13	IP67	✗	✗	50



Your Connection to Light

**TL**

Fittingen voor fluorescentielampen

Douilles pour lampes fluorescentes

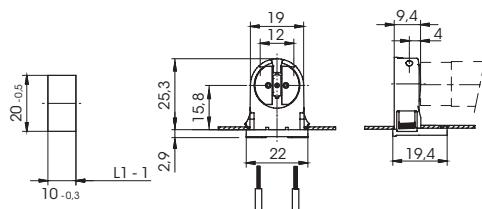

artikel article	type			
26.620.2004.50	G5	✗	✓	100

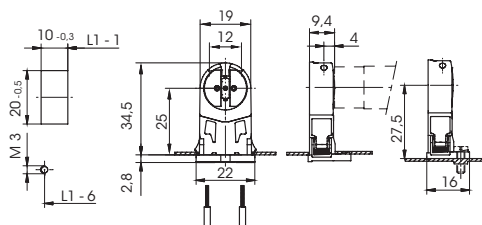

26.620.2012.50	G5	✓	✓	100
----------------	----	---	---	-----

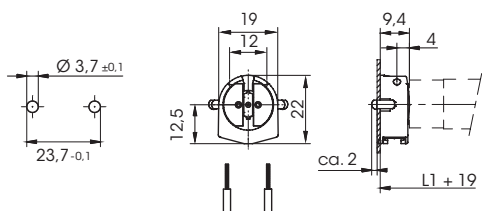

26.641.2001.50	G5	✗	✓	100
----------------	----	---	---	-----

**TL** Fittingen voor fluoresciëntielampen  
 Douilles pour lampes fluorescentes

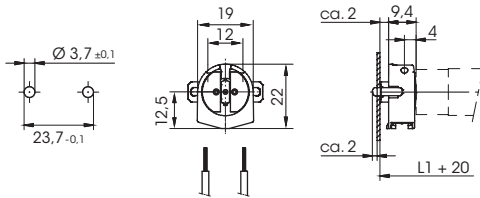

artikel article	type	CLICK	
26.641.2002.50	G5	✓	100

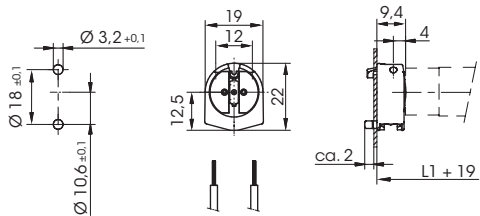

26.641.2003.50	G5	✓	100
----------------	----	---	-----

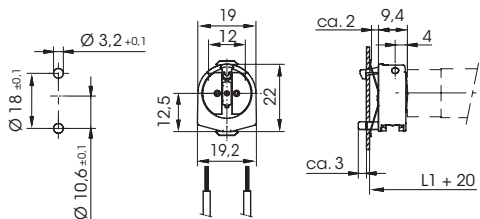

26.641.2004.50	G5	✓	100
----------------	----	---	-----

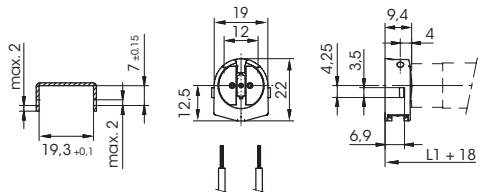

26.641.2006.50	G5	✓	1000
----------------	----	---	------

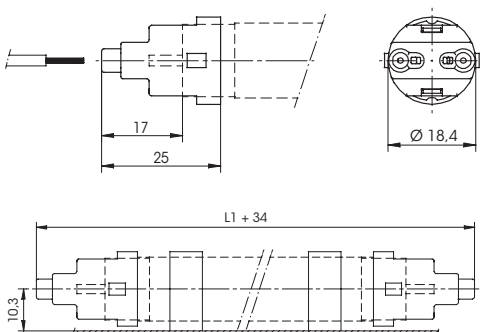

26.642.8601.50	G5	✗	100
----------------	----	---	-----

▲ Fittingen en toebehoren voor de verlichtingsindustrie  
 ▲ Douilles et accessoires pour l'industrie d'éclairage



Your Connection to Light

**TL**

Fittingen voor fluorescentielampen  
 Douilles pour lampes fluorescentes

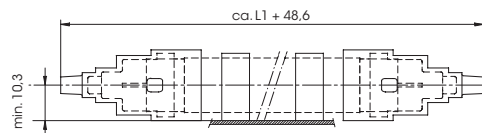

artikel article	type				
26.642.9001.50	G5	IP67	✗	✗	100

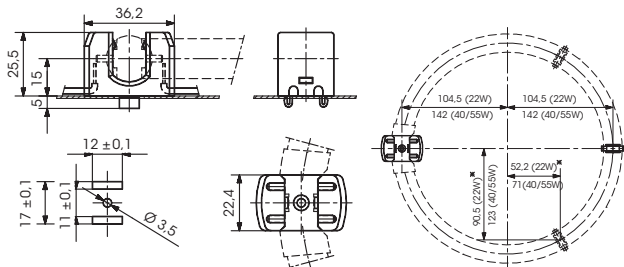

artikel article	type			
26.732.8101.50	2GX13	✗	✓	250

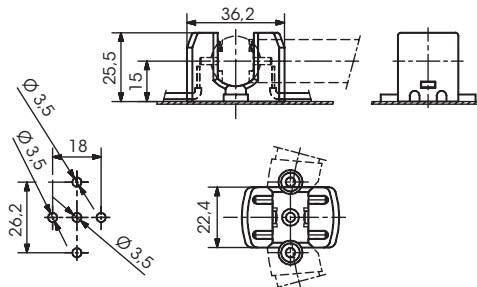

26.732.8201.50	2GX13	✓	✗	50
----------------	-------	---	---	----

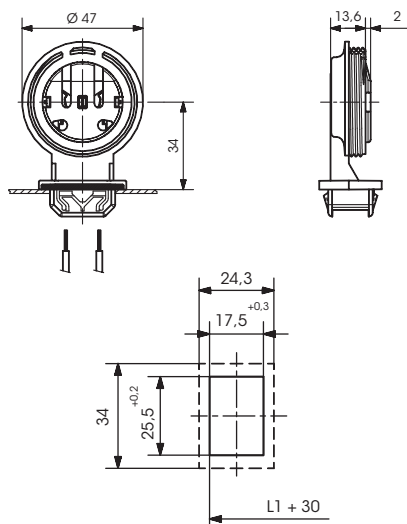

artikel article	type	kleur couleur			
27.240.U301.50	G13	○	✗	✓	100

**TL** Fittingen voor fluorescentielampen  
 Douilles pour lampes fluorescentes

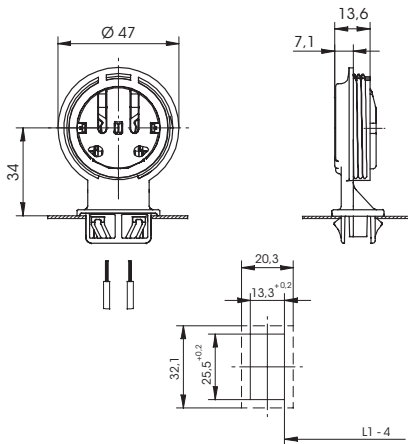

artikel article	type	kleur couleur			
27.240.U304.81	G13	●	✗	✓	100

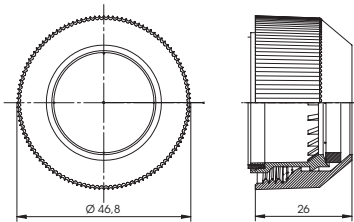

27.240.U401.50	G13	○	✓	✗	100
----------------	-----	---	---	---	-----

27.240.U401.81	G13	●	✓	✗	100
----------------	-----	---	---	---	-----

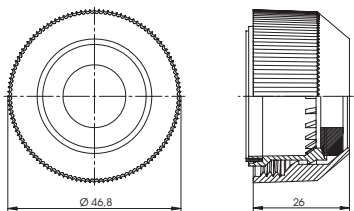

27.660.U301.50	G5	○	✓	✗	50
----------------	----	---	---	---	----

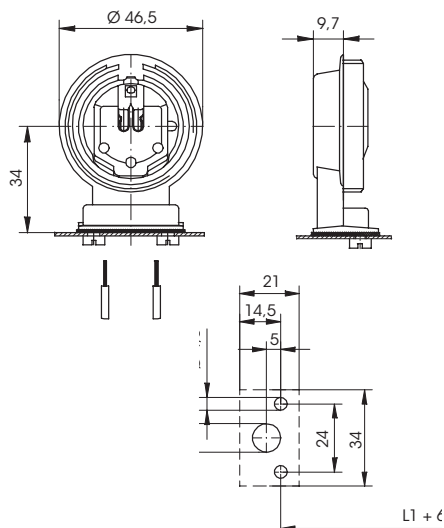

27.660.U810.50	G5	○	✓	✗	50
----------------	----	---	---	---	----





Your Connection to Light

**TL-ACC**

Starterhouders

Porte-starters

artikel article	type			
--------------------	------	--	--	--

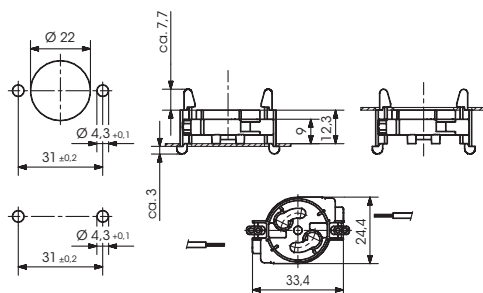

26.514.5011.50

G13

✗

✓

100

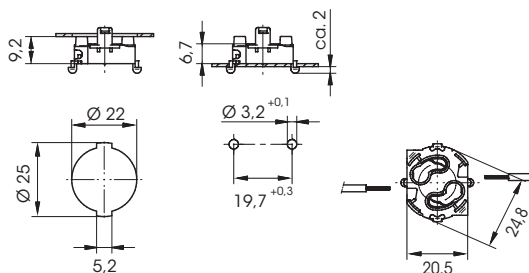

26.515.5317.50

G13

✗

✓

100

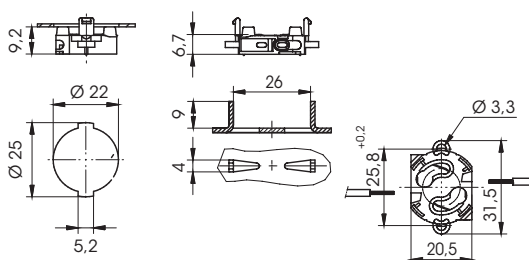

26.515.5318.50

G13

✗

✓

100

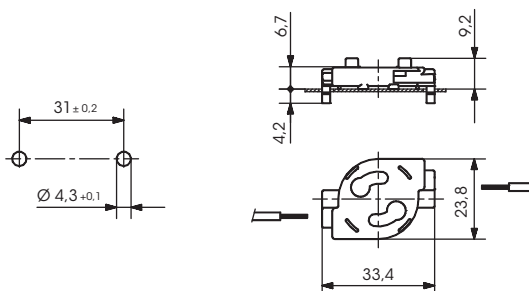

26.519.5001.50

G13



✗

✓

100

**TL-ACC**

Toebehoren fittingen voor fluorescentielampen  
 Accessoires de douilles pour lampes fluorescentes

artikel article	type			
26.642.-106.03	G5	✓	✗	100

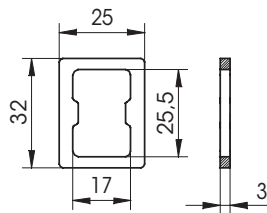
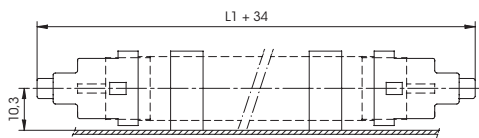
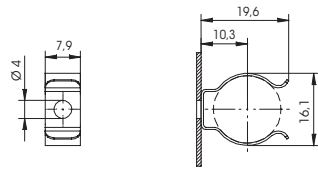

27.240.-703.00	G5 + G13	✗	✓	200
----------------	----------	---	---	-----

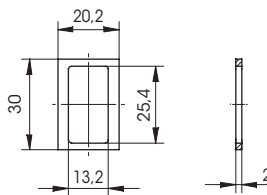

27.240.-716.00	G5 + G13	✗	✓	200
----------------	----------	---	---	-----

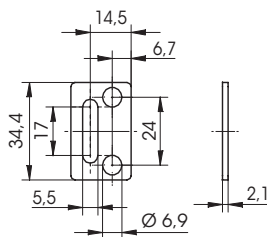

27.240.-835.00	G5 + G13	✓	✗	200
----------------	----------	---	---	-----



Your Connection to Light

**COMPACT FLUO**

Fittingen voor spaarlampen

Douilles pour lampes fluorescentes compactes

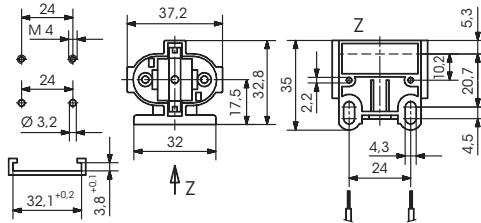
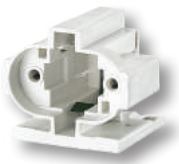

artikel article	type			
26.719.4355.50	G23	✓	✗	50

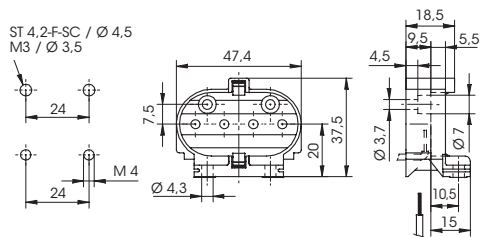

26.726.4803.50	2G11	✓	✗	50
----------------	------	---	---	----

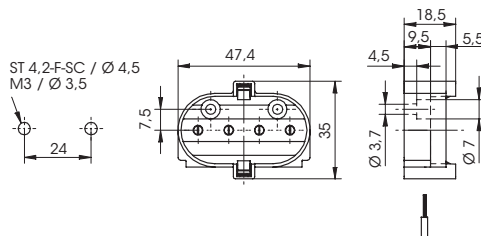

26.726.4805.50	2G11	✓	✗	250
----------------	------	---	---	-----

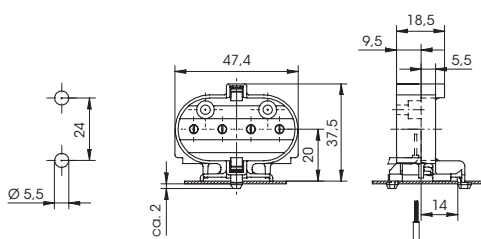

26.726.4807.50	2G11	✗	✓	50
----------------	------	---	---	----

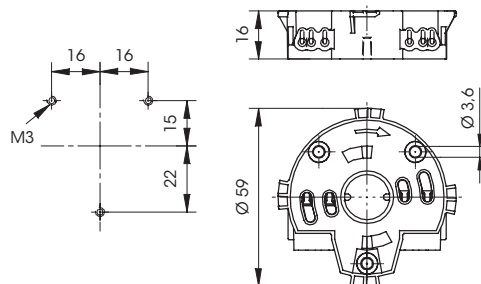

26.734.1002.50	2G8-1	✓	✗	50
----------------	-------	---	---	----

**COMPACT FLUO**

Fittingen voor spaarlampen

Douilles pour lampes fluorescentes compactes



artikel article	info	type			
26.745.1331.50	d3 (26 W/32 W)	G24 / GX24	✓	✓	50

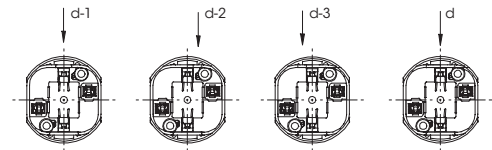
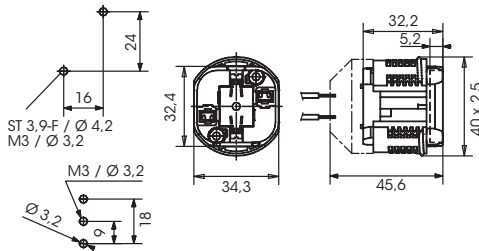

26.745.1361.50	q2 (18 W)	G24 / GX24	✓	✓	50
26.745.1371.50	q3 (26 W/32 W)	G24 / GX24	✓	✓	50

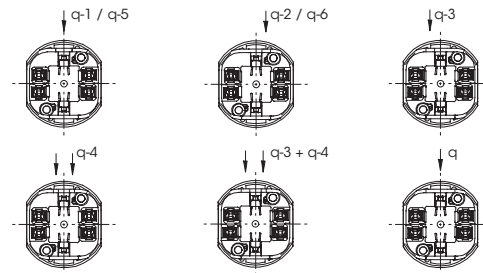
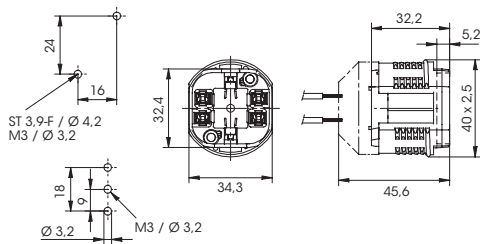

**COMPACT FLUO**

Fittingen voor spaarlampen

Douilles pour lampes fluorescentes compactes



artikel article	info	type			
26.745.1951.50	q1 (8 W/10 W/13 W)	G24 / GX24	✓	✓	50
26.745.1961.50	q2 (18 W)	G24 / GX24	✓	✓	50
26.745.1971.50	q3 (26 W/32 W)	G24 / GX24	✓	✓	50
26.745.1981.50	q4 (42 W)	G24 / GX24	✓	✓	50

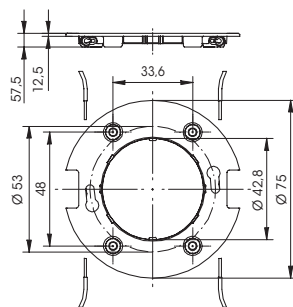
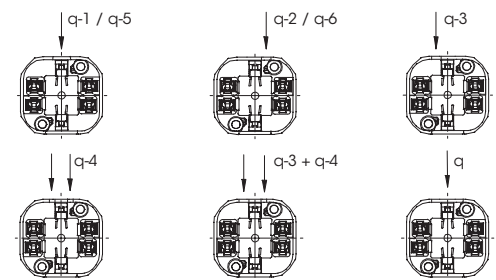
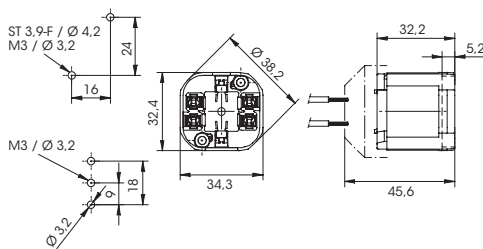

artikel article	type		
26.750.1003.50	GX53	✓	50

**COMPACT FLUO-ACC**

Toebehoren fittingen voor spaarlampen

Accessoires de douilles pour lampes fluorescentes compactes

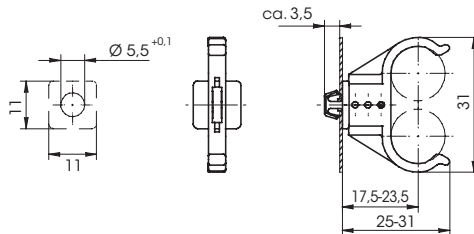

artikel article	type			
26.719.U310.50	G23	✗	✓	500

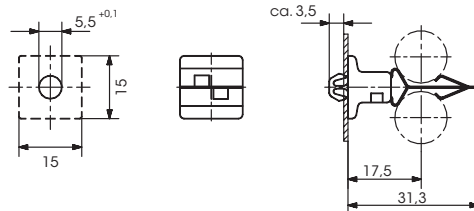

26.719.U811.10	G23	✗	✓	500
----------------	-----	---	---	-----

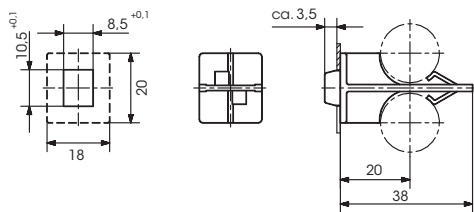

26.726.-012.50	2G11	✗	✓	100
----------------	------	---	---	-----

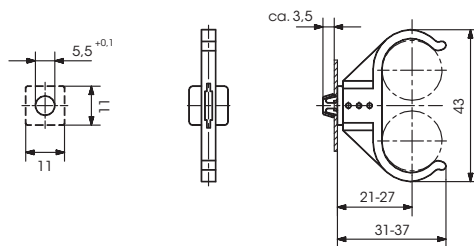

26.726.U310.50	2G11	✗	✓	500
----------------	------	---	---	-----

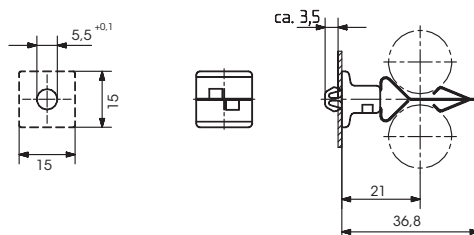

26.726.U811.10	2G11	✓	✗	100
----------------	------	---	---	-----



Your Connection to Light

**COMPACT FLUO-ACC**

Toebehoren fittingen voor spaarlampen

Accessoires de douilles pour lampes fluorescentes compactes

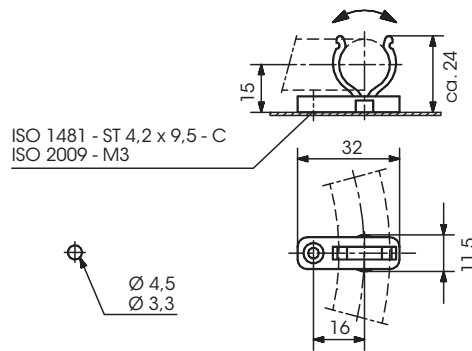

artikel article	type			
26.732.U811.50	2GX13	✓	✗	50

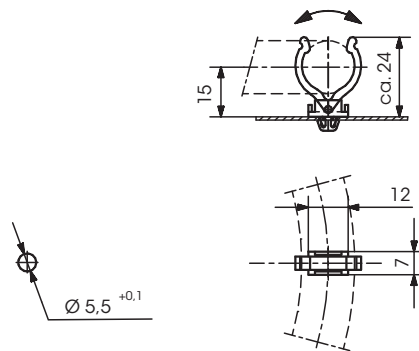

26.732.U821.50	2GX13	✗	✓	250
----------------	-------	---	---	-----

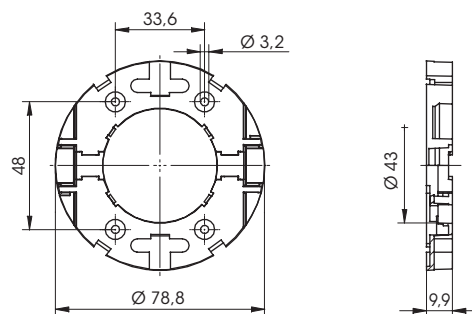

26.750.-803.80	GX53	✓	✗	50
----------------	------	---	---	----

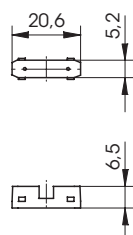

26.750.-805.80	GX53	✓	✗	50
----------------	------	---	---	----



**HALO LS**

Fittingen voor halogeenlampen laagspanning  
 Douilles pour lampes halogènes basse tension

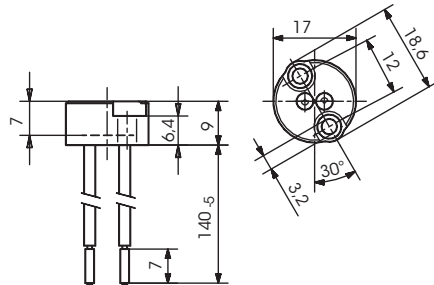

artikel article	type	temperatuur température		
25.104.3521.90	G4	-60° C +180° C	✓	50

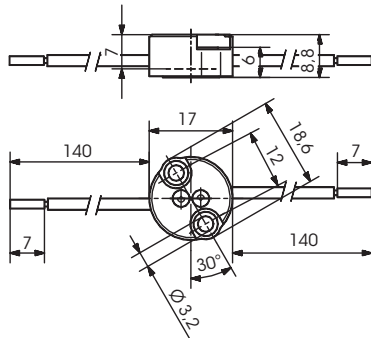

25.104.3621.00	G4	-60° C +180° C	✓	50
----------------	----	----------------	---	----

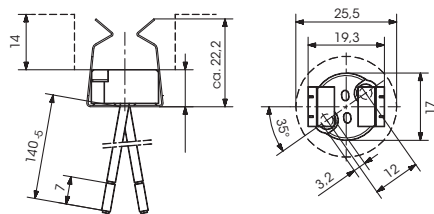

25.105.3101.00	GU5,3	-190° C +250° C	✓	50
----------------	-------	-----------------	---	----

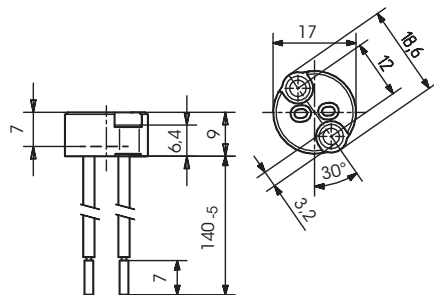
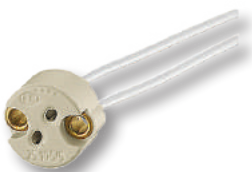

25.106.3501.00	GX5,3 GY6,35	-190° C +250° C	✓	50
----------------	-----------------	-----------------	---	----



Your Connection to Light

**HALO LS**

Fittingen voor halogeenlampen laagspanning  
 Douilles pour lampes halogènes basse tension

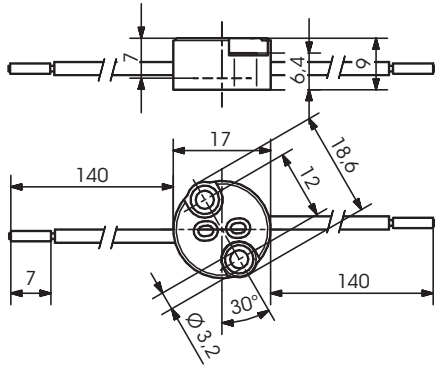

artikel article	type	temperatuur température			
25.106.3601.00	GX5,3 GY6,35	-190° C +250° C	✓	✗	50

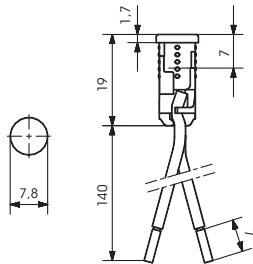
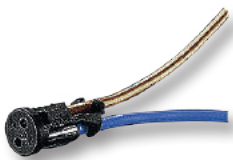

25.114.1121.90	G4	-60° C +180° C	✗	✓	50
----------------	----	----------------	---	---	----

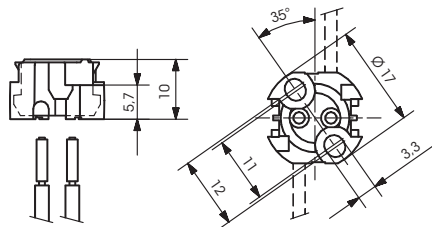

artikel article	type			
25.245.1000.90	GX5,3	✓	✓	500

**HALO LS-ACC**

Toebehoren fittingen voor halogeenlampen laagspanning  
 Accessoires de douilles pour lampes halogènes basse tension

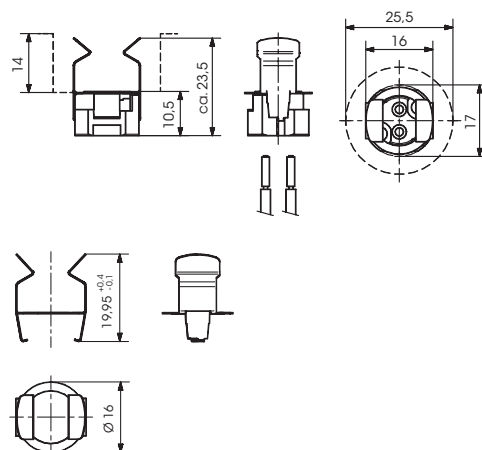

artikel article	type		
25.245.-103.00	GU5,3	✓	500

**HALO 230**

Fittingen voor halogeenlampen 230 V

Douilles pour lampes halogènes 230 V

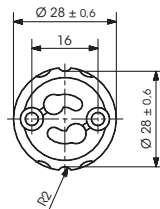
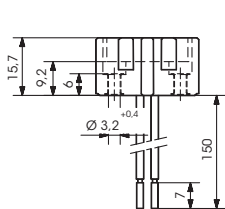

artikel article	type	temperatuur température		
25.818.2901.00	GZ10	-190° C +250° C	✓	50

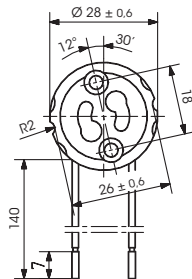
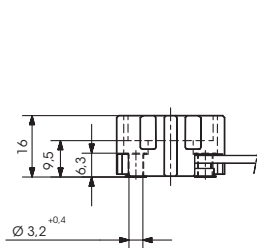

25.818.3801.00	GZ10	-190° C +250° C	✓	50
----------------	------	-----------------	---	----

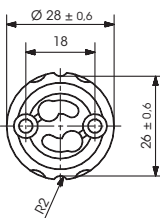
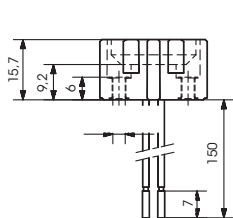

25.819.2901.00	GU10	-190° C +250° C	✓	50
----------------	------	-----------------	---	----

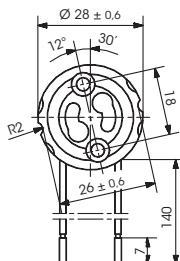
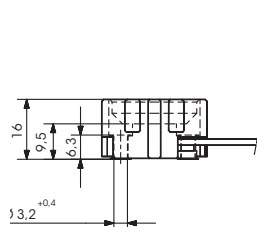

25.819.3801.00	GU10	-190° C +250° C	✓	50
----------------	------	-----------------	---	----



Your Connection to Light

**HALO 230**

Fittingen voor halogeenlampen 230 V  
 Douilles pour lampes halogènes 230 V

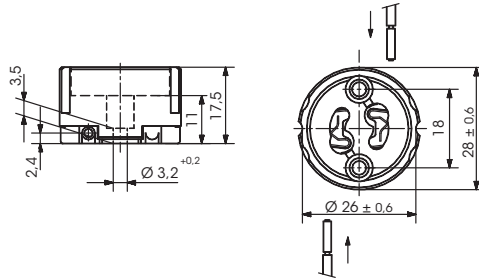

artikel article	type		
25.828.2000.00	GZ10	✓	50

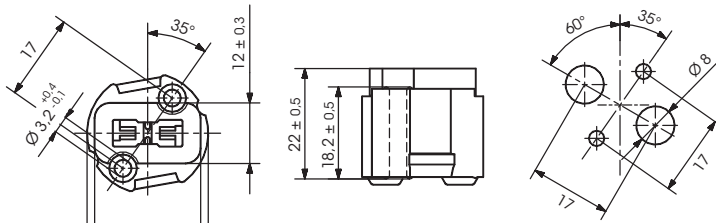

25.830.1000.00	G9	✓	50
----------------	----	---	----

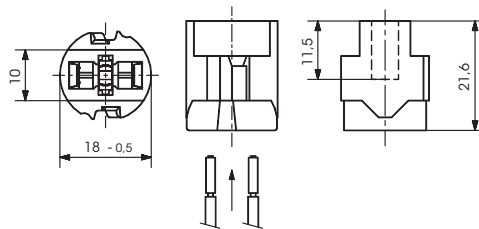

25.834.1000.00	G9	✗	50
----------------	----	---	----

**HALO 230-ACC**

Toebehoren fittingen voor halogeenlampen 230 V

Accessoires de douilles pour lampes halogènes 230 V

artikel article	type			
25.904.-336.51	G9	✓	✗	100

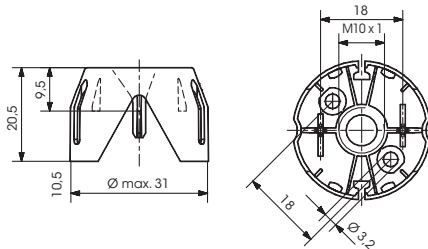
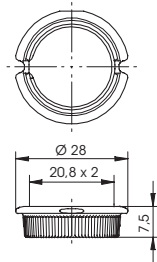

25.919.-301.51	GU10 GZ10	✓	✗	50
----------------	--------------	---	---	----

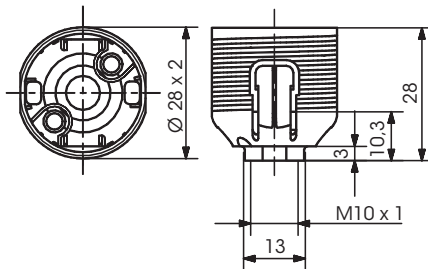

25.930.-311.51	G9	✗	✓	50
----------------	----	---	---	----

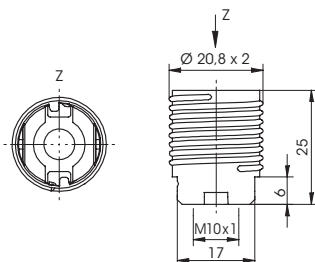

25.934.-301.51	G9	✓	✗	50
----------------	----	---	---	----



Your Connection to Light

**HID**

Fittingen voor gasontladinglampen

Douilles pour lampes à décharge

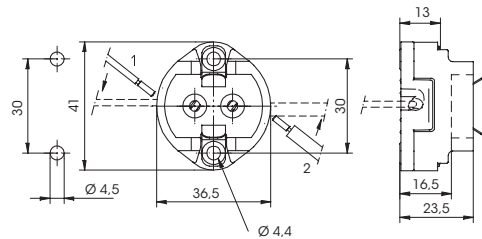

artikel article	type		
25.701.1000.00	G12	✓	50

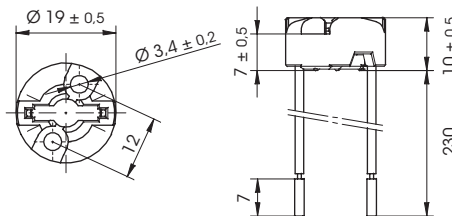

artikel article	type	temperatuur température		
25.704.3001.00	PGJ5	-190° C +250° C	✓	50

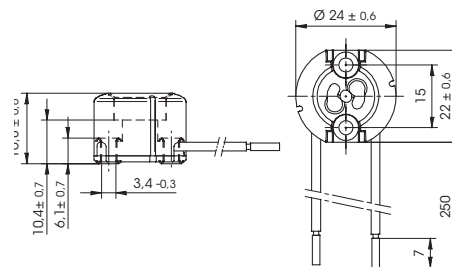

25.705.1001.00	GU6,5	-190° C +250° C	✓	50
----------------	-------	-----------------	---	----

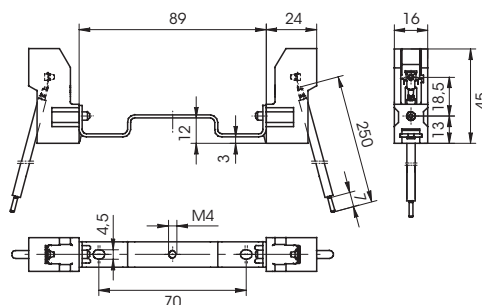

artikel article	type		
25.808.4013.00	RX7s	✓	10

**HID**

Fittingen voor gasontladingslampen

Douilles pour lampes à décharge

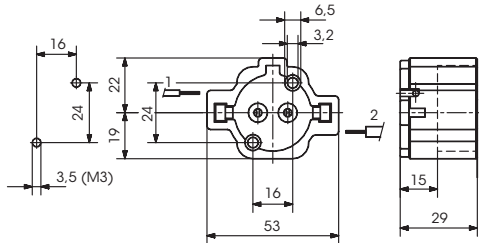

artikel article	type		
25.810.3900.00	PGX12-2	✓	10

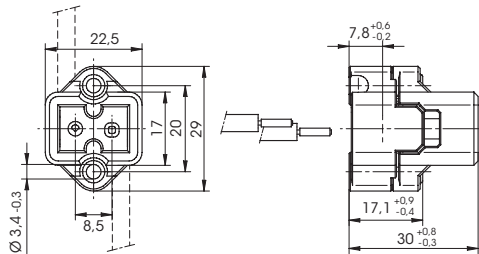

25.822.1001.00	G8,5	✓	50
----------------	------	---	----

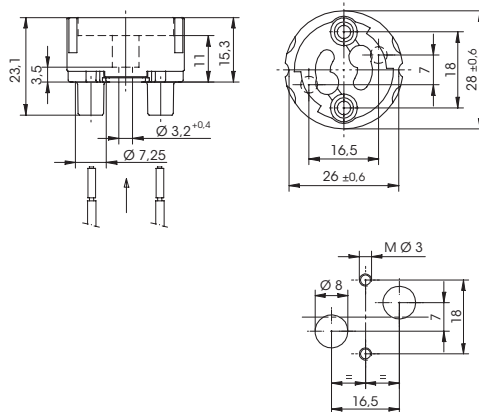

25.835.1000.00	GX10	✓	50
----------------	------	---	----





Your Connection to Light

**HID**

Fittingen voor gasontladingslampen

Douilles pour lampes à décharge

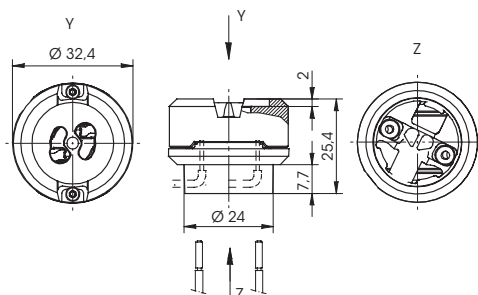

artikel article	type	
25.836.1000.00	GX8,5	50

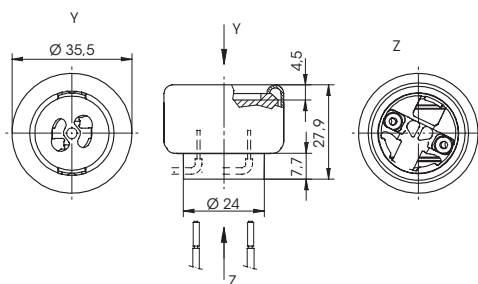

25.836.2000.00	GX8,5	50
----------------	-------	----

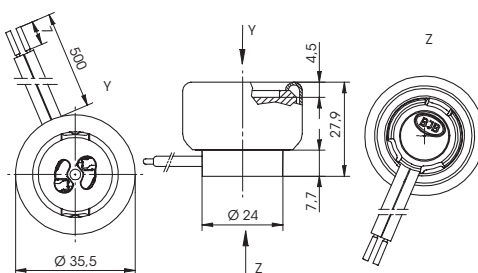

artikel article	type	temperatuur température	
25.836.2001.00	GX8,5	-190° C +250° C	20

**HID-ACC**

Toebehoren fittingen voor gasontladingslampen

Accessoires de douilles pour lampes à décharge

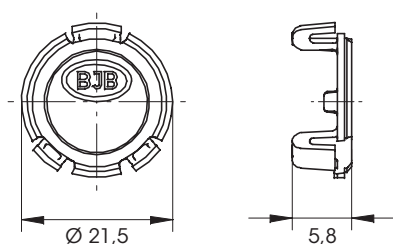

artikel article	type	kleur couleur		
25.836.-302.80	GX8,5	●	✓	50

**P2F**

Toebehoren voor LED-pcb's

Accessoires pour platines LED

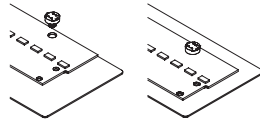
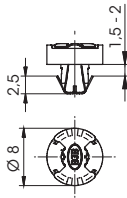

artikel article	type	kleur couleur	CLICK	
28.901.U162.10	LED	○	✓	500

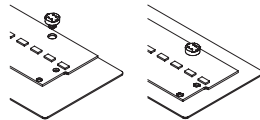
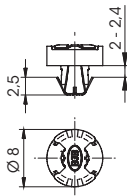
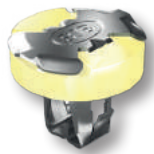

28.901.U163.10	LED	●	✓	500
----------------	-----	---	---	-----

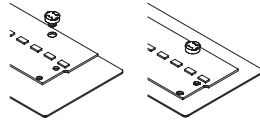
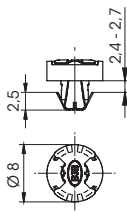

28.901.U164.10	LED	●	✓	1000
----------------	-----	---	---	------

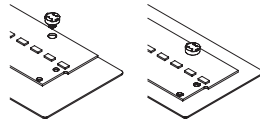
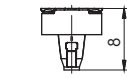
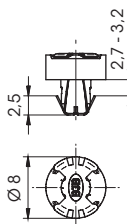

28.901.U165.10	LED	○	✓	1000
----------------	-----	---	---	------

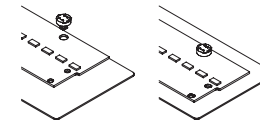
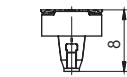
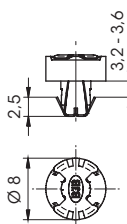
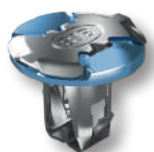

28.901.U166.10	LED	●	✓	1000
----------------	-----	---	---	------



Your Connection to Light

**CON**

Klemmen  
Borniers

artikel article	type	CLICK	
--------------------	------	-------	--

46.412.1100.50	CON	✓	100
----------------	-----	---	-----

46.413.1100.50	CON	✓	500
----------------	-----	---	-----

46.413.1111.50	CON	✓	500
----------------	-----	---	-----

46.413.1114.50	CON	✓	100
----------------	-----	---	-----

46.413.1115.50	CON	✓	100
----------------	-----	---	-----

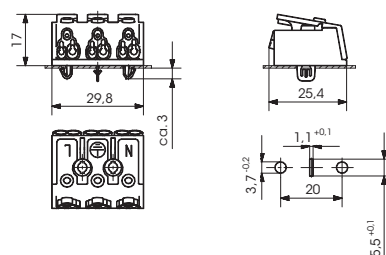
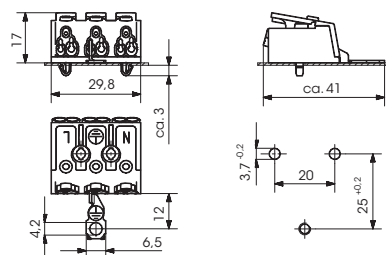
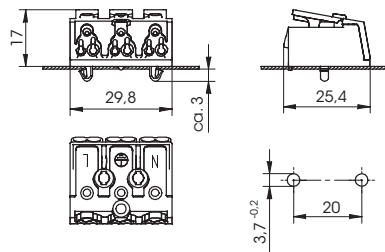
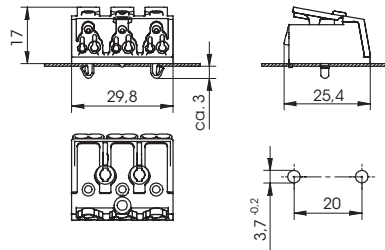
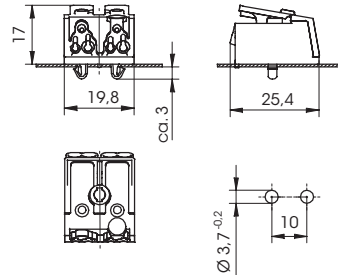

**CON**

Klemmen  
Borniers

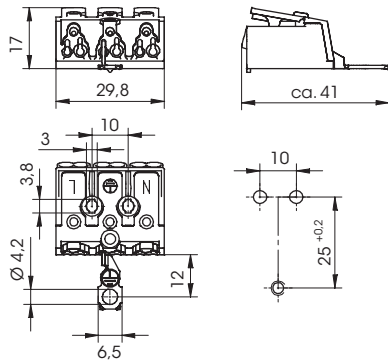

artikel article	type			
46.413.1214.50	CON	✓	✗	100

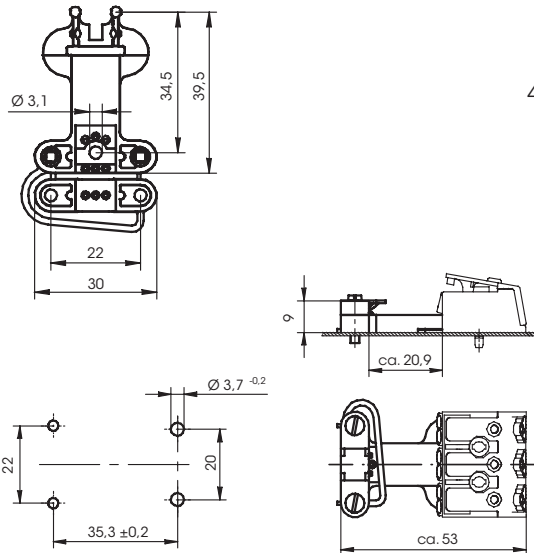
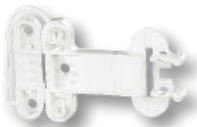

46.413.-352.50	CON	✓	✗	500
----------------	-----	---	---	-----

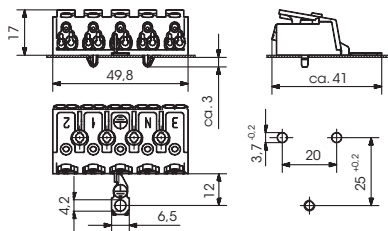

46.415.1114.50	CON	✗	✓	50
----------------	-----	---	---	----

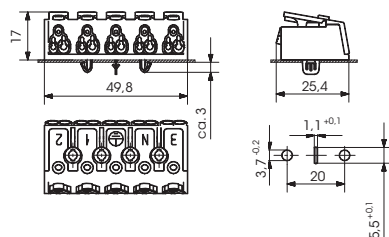

46.415.1115.50	CON	✗	✓	250
----------------	-----	---	---	-----



### **Toepasselijkheid van de algemene voorwaarden:**

Elke verkoop van goederen of diensten door 4K nv, evenals de overeenkomst tot aanneming van werken is onderworpen aan de onderhavige contract-voorwaarden. Door het aangaan van overeenkomst aanvaardt de klant de exclusieve toepassing van de contractvoorwaarden van 4K nv, met uitsluiting van enige andere voorwaarden. Afwijking hiervan is slechts mogelijk mits uitdrukkelijke schriftelijke overeenkomst.

De klant aanvaardt eventuele wijzigingen en verbindt zich bij elke estelling tot de contractvoorwaarden toepasselijk op het ogenblik van het afsluiten of verlengen van de overeenkomst volgens de voorwaarden gepubliceerd door 4K nv op zijn website. Wijziging of vernietiging van één of meerdere bepalingen, geheel of gedeeltelijk, zal geen verzaking of vernietiging van de overige voorwaardentot gevolg hebben.

### **Totstandkoming van het contract:**

Offertes zijn vrijblijvend. De prijzen zijn slechts geldig voor een duurtijd van 15 dagen, behoudens andersluidend schriftelijk akkoord. Overeenkomst komt slechts tot stand mits schriftelijke aanvaarding van de bestelling door 4K nv.

### **Termijnen van levering:**

Termijnen van levering zijn slechts benaderend en niet bindend. 4K nv is niet verantwoordelijk voor vertraging. In geen enkel geval kan vertraging aanleiding geven tot schadeloosstelling of annulatie van een bestelling.

### **Kostprijs en betalingsvoorwaarden:**

Belastingen en kosten van levering en transport zijn niet inbegrepen in de prijs-opgave, behoudens andersluidende overeenkomst. De facturen zijn contant verschuldigd op de maatschappelijke zetel. In het geval van afwijkende betaaltermijnen kunnen deze nooit ingeroepen worden als verworven recht. Alle bankkosten zijn ten laste van de klant. 4K nv is slechts gehouden tot levering na betaling van de facturen. Bij gebreke aan schriftelijk protest binnen de 8 dagen na verzending van de factuur of vordering, zal deze gelden als aanvaard en niet betwist.

Het trekken en/of aanvaarden van wissels of andere verhandelbare documenten, houdt geen schuldvernieuwing in en vormt geen afwijking van de onderhavige verkoopvoorwaarden.

Indien de kredietwaardigheid een minder gunstige wending neemt, behoudt 4K nv zich het recht voor, zelfs na gedeeltelijke uitvoering van het contract, waarborgen te eisen van de klant tot de uitvoering van zijn verbintenissen. Bij gebreke aan waarborgen kan 4K nv de gehele bestelling of een gedeelte ervan annuleren. 4K nv is gerechtigd de werken en/of de levering op te schorten, van zodra er risico van wanbetaling is of enige schuld op de vervaldatum niet vereffend werd. De opschorting van de werken en/of levering geldt onverminderd de betaalplicht van de klant in hoofdsom, intresten en kosten.

### **Vervoer:**

De levering vindt plaats in de magazijnen van 4K nv. Het transport geschiedt in opdracht en voor rekening van de klant. Bij wijze van dienstverlening kan 4K nv de goederen laten afleveren bij de klant. Dit voordeel kan nooit worden beschouwd als een verworven recht voor andere transacties. De goederen reizen steeds op risico van de klant, zelfs indien het transport gebeurt voor rekening van 4K nv. Bij ophaling van de goederen door een transporteur zal 4K nv de vrachtbrief mogen ondertekenen bij volmacht in naam van de klant als verzender van het transport.

### **Klachten:**

Geen klachten zullen aanvaard worden indien zij niet schriftelijk aangetekend worden gemeld binnen 8 dagen na de levering van goederen of uitvoering van werken. De klant is ertoe gehouden de geleverde goederen of uitgevoerde werken onmiddellijk na te zien.

### **Waarborg en exoneratie:**

De klant wordt verondersteld de materialen, desgevallend de uit te voeren werken en hun specifieke eigenschappen te kennen alvorens tot een bestelling over te gaan. Hij neemt alle verantwoordelijkheid met betrekking tot de toepassing of het gebruik van de materialen of de werken die werden gevraagd. De waarborg voor zichtbare gebreken is beperkt tot een termijn van 8 dagen. De waarborg voor verborgen gebreken is steeds beperkt tot een duurtijd van 1 jaar na levering of uitvoering van het werk. In elk geval is aangetekende kennisgeving vereist binnen 8 dagen na de ontdekking hiervan, op straffe van verval.

Onverminderd de voormelde uitsluitingen van verantwoordelijkheid, beperkt de waarborg zich tot het vervangen van niet-conforme of gebrekkige goederen, hetzij gedeeltelijke of volledige terugbetaling van de prijs van de goederen, hetzij de heruitvoering van de werken in natura of de prijs hiervan, naar keuze van 4K nv. Alle andere kosten en vergoedingen voor rechtstreekse of onrechtstreekse schade, zijn uitgesloten.

### **Betaling:**

In het geval van wanbetaling zal het factuurbedrag van rechtswege en zonder ingebrekestelling verhoogd worden met een forfaitaire schadevergoeding van 10 %, met een minimum van 50 €, alsook de intresten toepasselijk volgens de wet betalingsachterstand bij handelstransacties d.d. 2.8.2002. Tevens zullen de kosten van invordering, gerechtelijke procedure en bijstand van advocaat verschuldigd zijn.

4K nv is gerechtigd de betalingen toe te rekenen op de vervallen schuld naar zijn keuze. De niet-betaling op zijn vervaldag van één enkele factuur maakt het verschuldigd saldo van al de andere zelfs niet vervallen facturen van rechtswege onmiddellijk opeisbaar.

### **Ontbinding:**

Wanneer de klant nalaat zijn verbintenissen uit te voeren, kan naar keuze van 4K nv de overeenkomst van rechtswege en zonder voorafgaande ingebrekestelling ontbonden worden, door kennisgeving bij gewone brief aan de klant. Een schadevergoeding zal forfaitair door de klant verschuldigd zijn ten belope van 30% van de prijs van de ontbonden transactie, onverminderd het recht op een hogere schadevergoeding mits het bewijs hiervan.

### **Eigendomsvoorbehoud:**

Onverminderd het risico van de goederen dat overgaat op de klant vanaf het verlaten van de magazijnen van 4K nv, blijven de geleverde en te leveren materialen eigendom van 4K nv tot de volledige betaling van prijs en toebehoren. Dit geldt eveneens wanneer de goederen werden gewijzigd of geïncorporeerd bij de klant.

### **Geschillen:**

Enkel het Belgisch recht is van toepassing. Bij betwisting zijn de rechtbanken bevoegd van het gebied waar de maatschappelijke zetel van 4K nv is gevestigd.



### **Applicabilité des conditions générales:**

Toute vente de marchandises ou services par 4K sa, ainsi que tout contrat de marché de travaux est soumis aux présentes conditions contractuelles. En concluant le présent contrat, le client accepte l'application exclusive des conditions contractuelles d'4K sa, à l'exclusion de toutes autres conditions. Toute dérogation à cette disposition n'est possible que sur accord écrit exprès. Le client accepte les éventuelles modifications et s'engage à respecter lors de toute commande les conditions contractuelles applicables au moment de la conclusion ou de la prolongation du contrat, telles que publiées par 4K sa sur son site web. La modification ou l'annulation complète ou partielle d'une ou plusieurs dispositions n'aura nullement pour effet l'abandon ou l'annulation des autres conditions.

### **Formation du contrat:**

Les offres sont sans engagement. Les prix ont une validité de 15 jours, sauf si spécifiquement convenu autrement par écrit. Le contrat entre uniquement en vigueur après l'acceptation écrite de la commande par 4K sa.

### **Délais de livraison:**

Les délais de livraison sont donnés à titre purement indicatif et ne sont nullement contraignants. 4K sa ne peut être tenue pour responsable des retards. Un retard ne peut en aucun cas donner lieu à une indemnisation ou à l'annulation d'une commande.

### **Prix de revient et conditions de paiement:**

Les taxes et frais de livraison et de transport ne sont pas inclus dans le devis, sauf si convenu autrement. Les factures sont payables au comptant au siège social. Si un délai de paiement spécifique est convenu, celui-ci ne peut en aucun cas être considéré comme un droit acquis. Tous les frais bancaires sont à charge du client. 4K sa est uniquement tenue à la livraison, après paiement des factures. A défaut de réclamation écrite dans les 8 jours à compter de l'envoi de la facture ou de la créance, celle-ci sera considérée comme ayant été acceptée et n'étant pas contestée.

Le tirage et/ou l'acceptation de lettres de change ou autres titres négociables n'entraîne aucune novation et ne constitue nullement une dérogation aux présentes conditions de vente.

Si la solvabilité du client est mise à mal, 4K sa se réserve le droit de réclamer des garanties d'exécution des engagements pris par le client, même après exécution partielle du contrat. A défaut de garanties, 4K sa peut annuler l'intégralité ou une partie de la commande. 4K sa est habilitée à suspendre les travaux et/ou la livraison, en cas de risque de non-paiement ou si une dette n'est pas honorée à son échéance. La suspension des travaux et/ou de la livraison n'affecte en rien l'obligation de paiement du capital, des intérêts et des frais dans le chef du client.

### **Transport:**

La livraison a lieu dans les entrepôts d'4K sa. Le transport intervient à la demande et pour le compte du client. A titre de service, 4K sa peut faire livrer la marchandise chez le client. Ce service ne peut jamais être considéré comme un droit acquis pour d'autres transactions. Les marchandises voyagent toujours aux risques du client, même si le transport est effectué pour le compte d'4K sa. En cas d'enlèvement des marchandises par un transporteur, 4K sa pourra signer la lettre de voiture par procuration au nom du client, en qualité d'expéditeur de la marchandise.

### **Plaintes:**

Les plaintes ne seront acceptées que si elles sont signifiées par écrit dans les 8 jours suivant la livraison des marchandises ou l'exécution des travaux. Le client est tenu de contrôler immédiatement les marchandises livrées ou les travaux effectués.

### **Garantie et exonération:**

Le client est présumé connaître les matériaux ou, le cas échéant, les travaux à effectuer et leurs propriétés spécifiques, avant de procéder à la commande. Il assume l'entière responsabilité relative à l'application ou à l'usage des matériaux ou des travaux demandés.

La garantie couvrant les défauts visibles est limitée à une période de 8 jours. La garantie pour vices cachés est toujours limitée à une période d'un an à compter de la livraison ou de l'exécution des travaux. Dans tous les cas, une notification par lettre recommandée est requise dans les 8 jours suivant leur découverte, sous peine d'extinction.

Sans préjudice des exclusions de responsabilité susmentionnées, la garantie se limite au remplacement des marchandises non conformes ou défectueuses, ou au remboursement total ou partiel du prix des marchandises, ou à la ré-exécution des travaux en nature ou au remboursement de leur prix, au choix d'4K sa. Tous les autres frais et indemnisations découlant de dommages directs ou indirects sont exclus.

### **Résiliation:**

Si le client omet de respecter ses engagements, 4K sa peut, à son entière discrétion, résilier le contrat de plein droit et sans mise en demeure préalable sur signification par courrier ordinaire au client. Une indemnisation forfaitaire de 30% du prix de la transaction résiliée sera due par le client, sans préjudice du droit d'4K sa à réclamer un dédommagement supérieur s'il est justifié.

### **Réserve de propriété:**

Sans préjudice de la transmission du risque au client dès le moment où les marchandises quittent les entrepôts d'4K sa, les marchandises livrées et à livrer demeurent la propriété d'4K sa jusqu'au paiement intégral de leur prix et des accessoires. Cette disposition est également applicable si les marchandises ont été modifiées ou incorporées par le client.

### **Litiges:**

Seul le droit belge est applicable. En cas de litige, les tribunaux du siège social d'4K sa sont compétents.



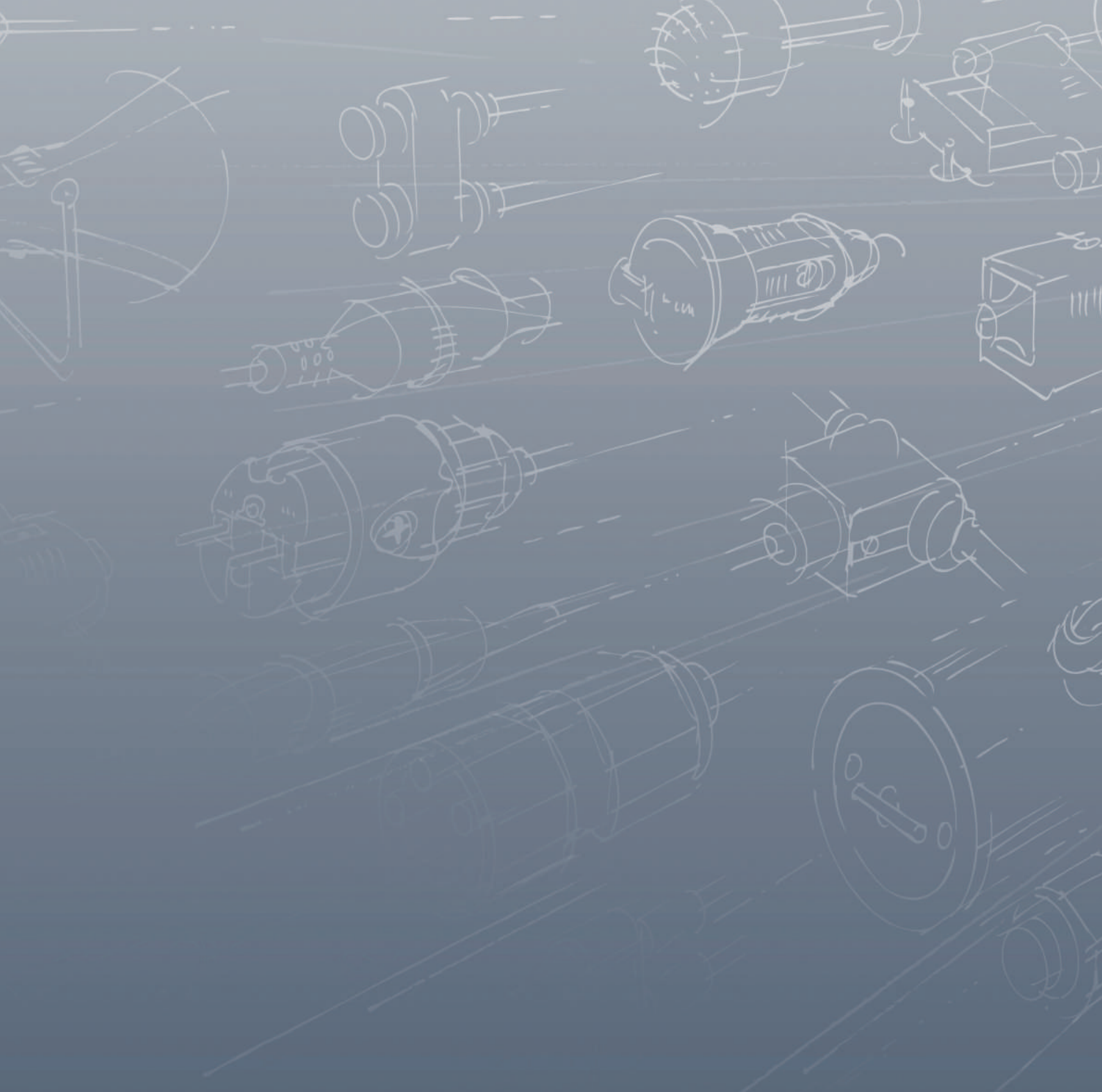

▲ warn | connect | protect

---

4K nv • Walgracht 55 • 9940 Evergem • België • [www.4K.be](http://www.4K.be)

4K nv • Fortsesteenweg 25 • 2860 Sint-Katelijne-Waver • België • [www.4K.be](http://www.4K.be)